

Backview (1:10)

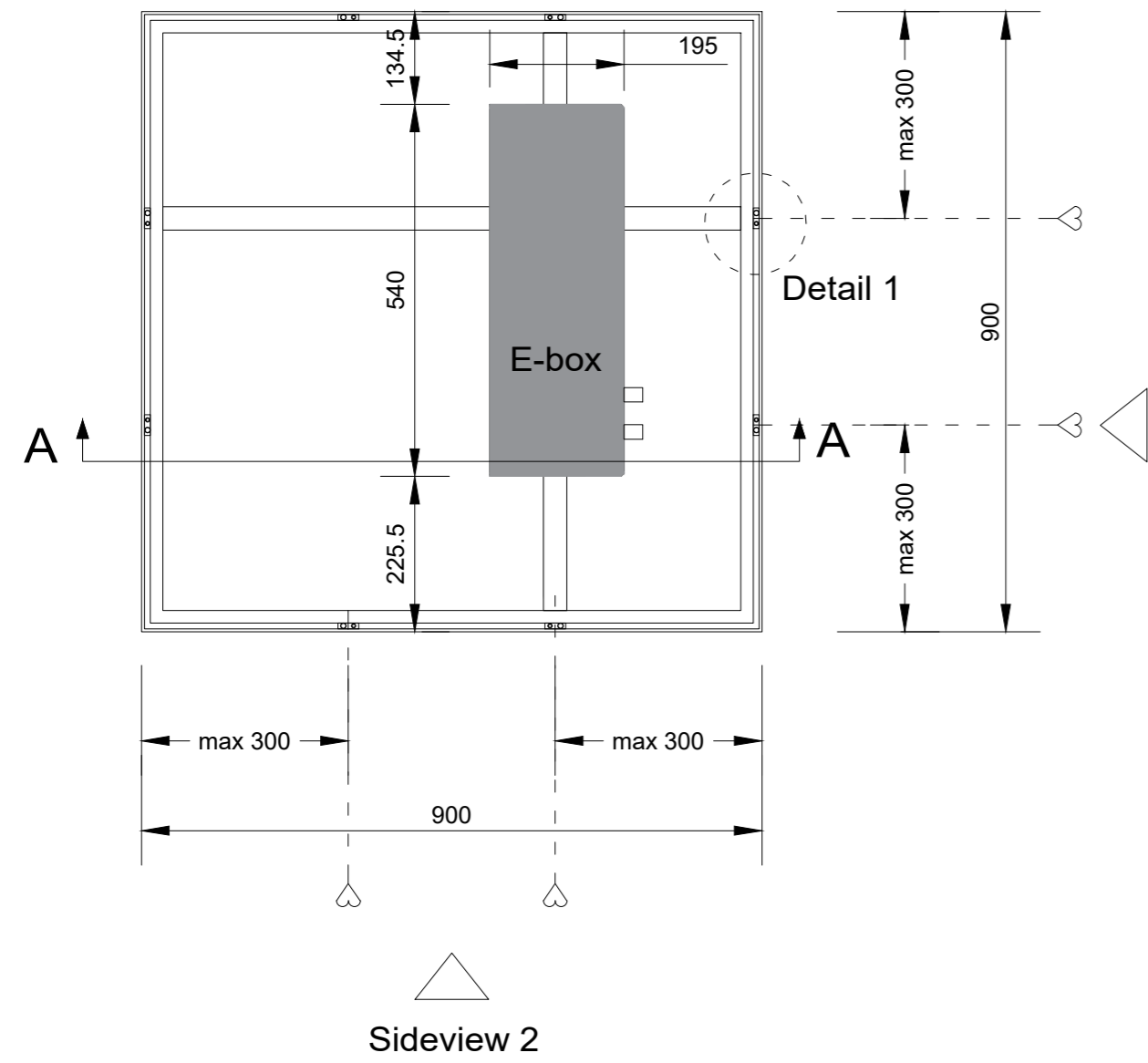

Sideview 1 - mounting position (1:10)

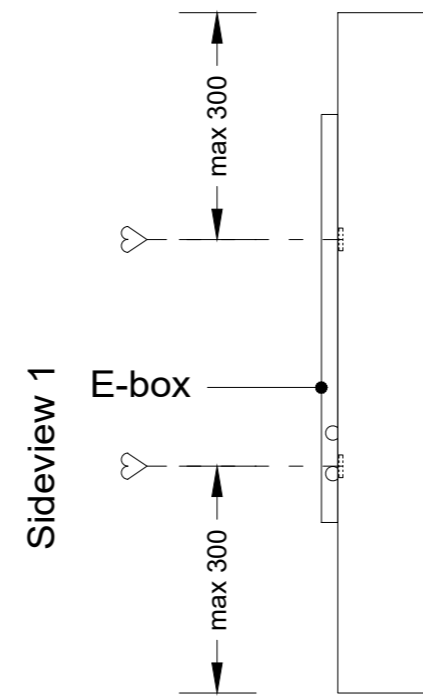

Sideview 2 - mounting position (1:10)

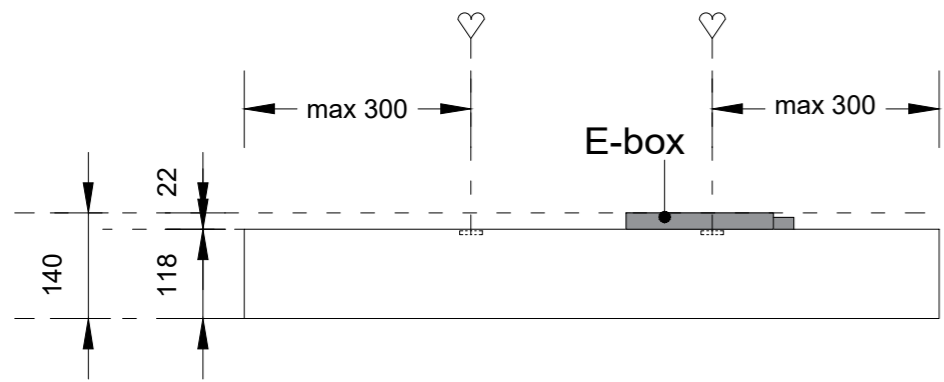

Section A-A (1:10)

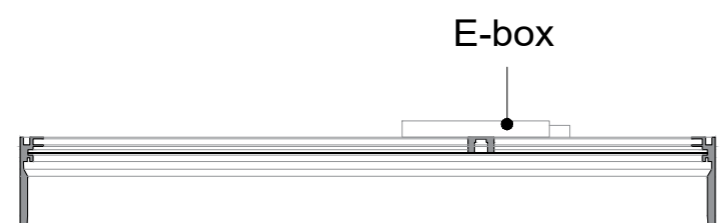

Detail 1 (1:1)

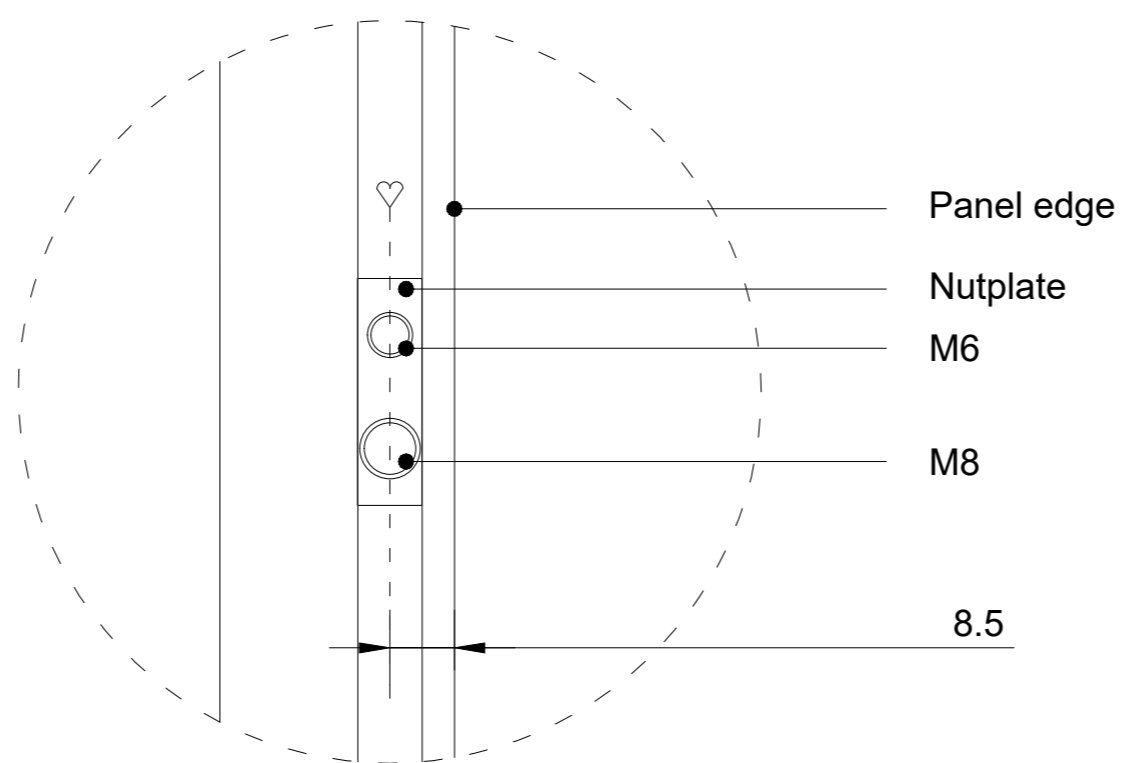

Backview (1:10)

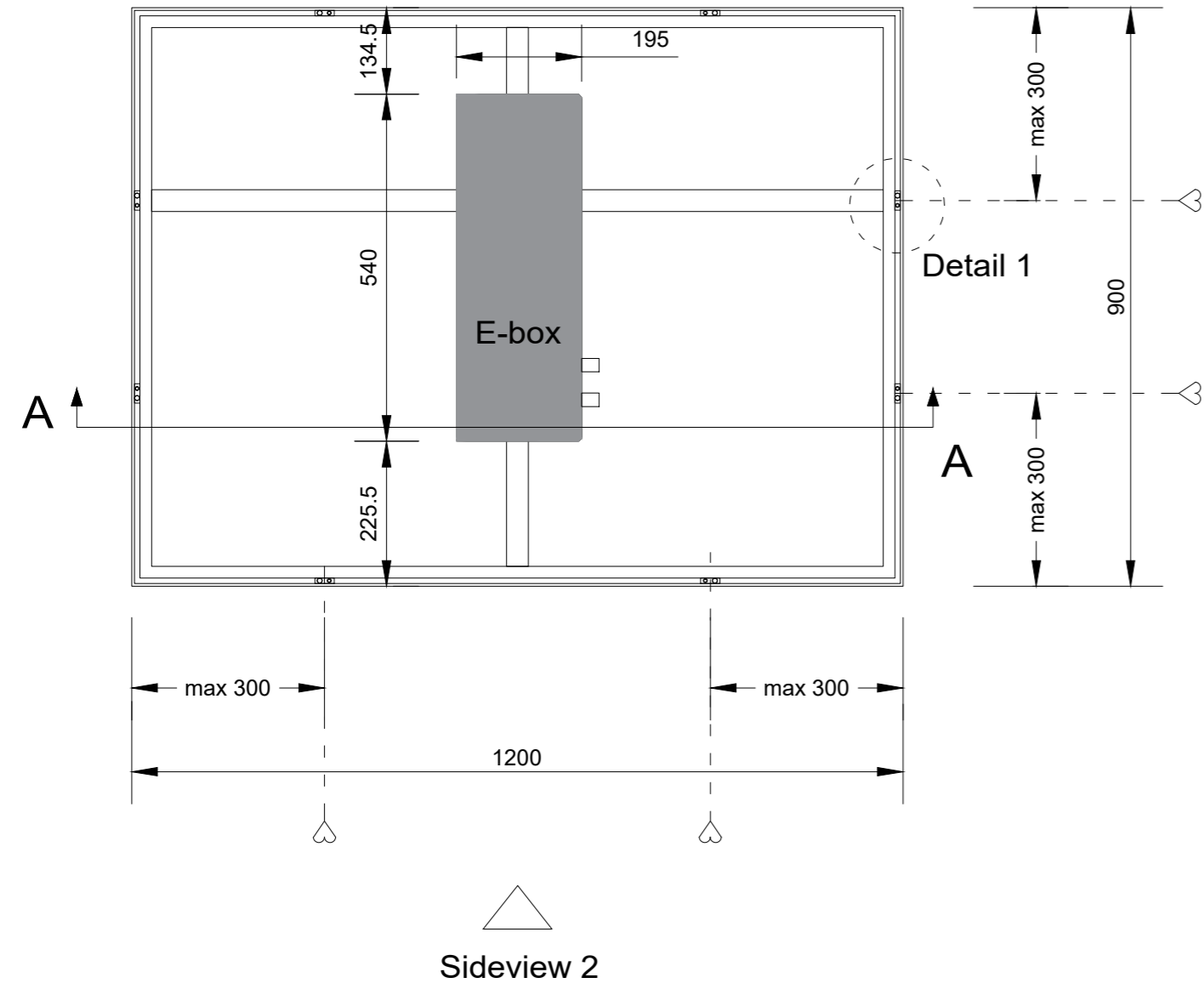

Sideview 1 - mounting position (1:10)

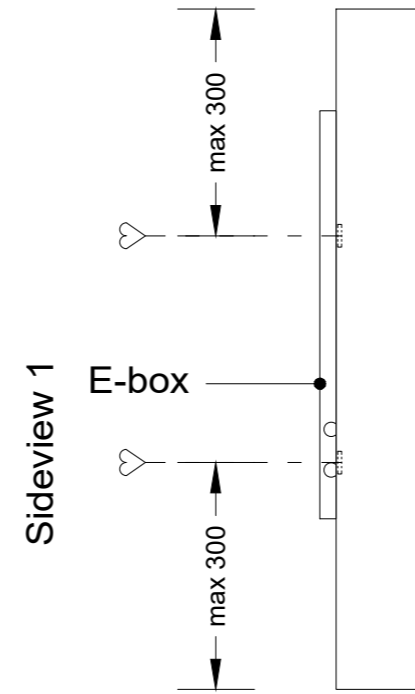

Sideview 2 - mounting position (1:10)

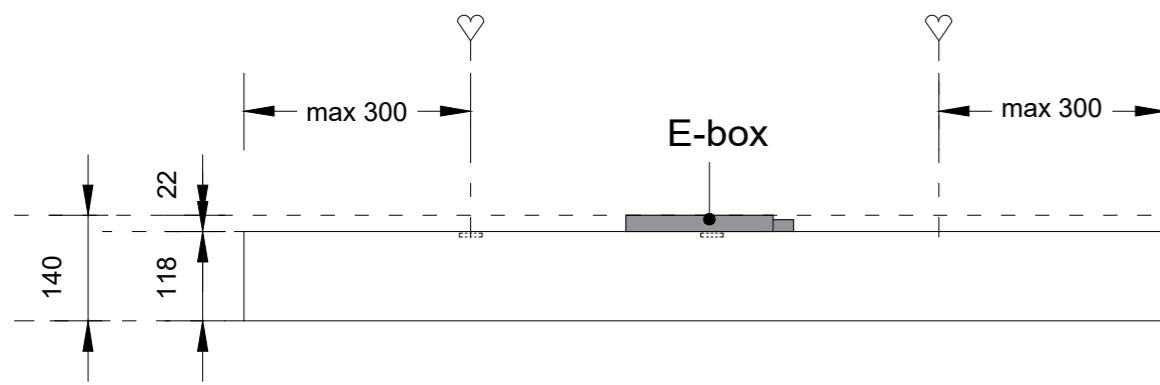

Section A-A (1:10)

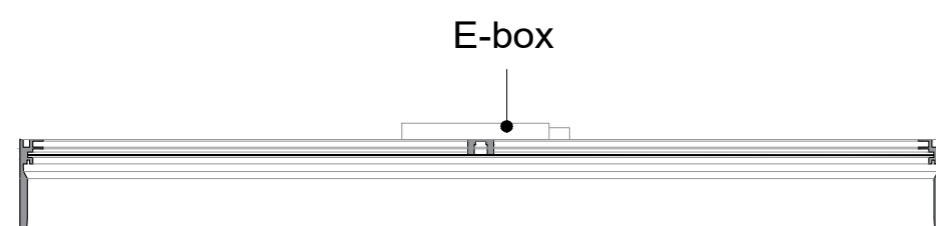

Detail 1 (1:1)

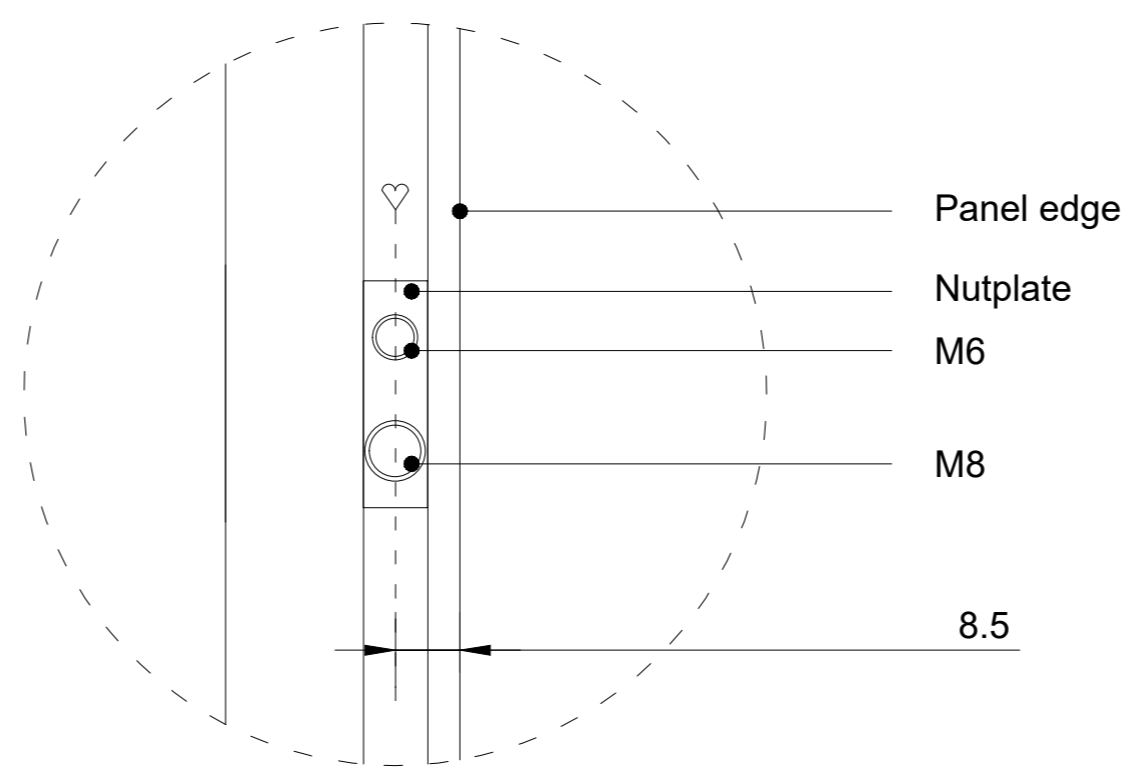

Backview (1:10)

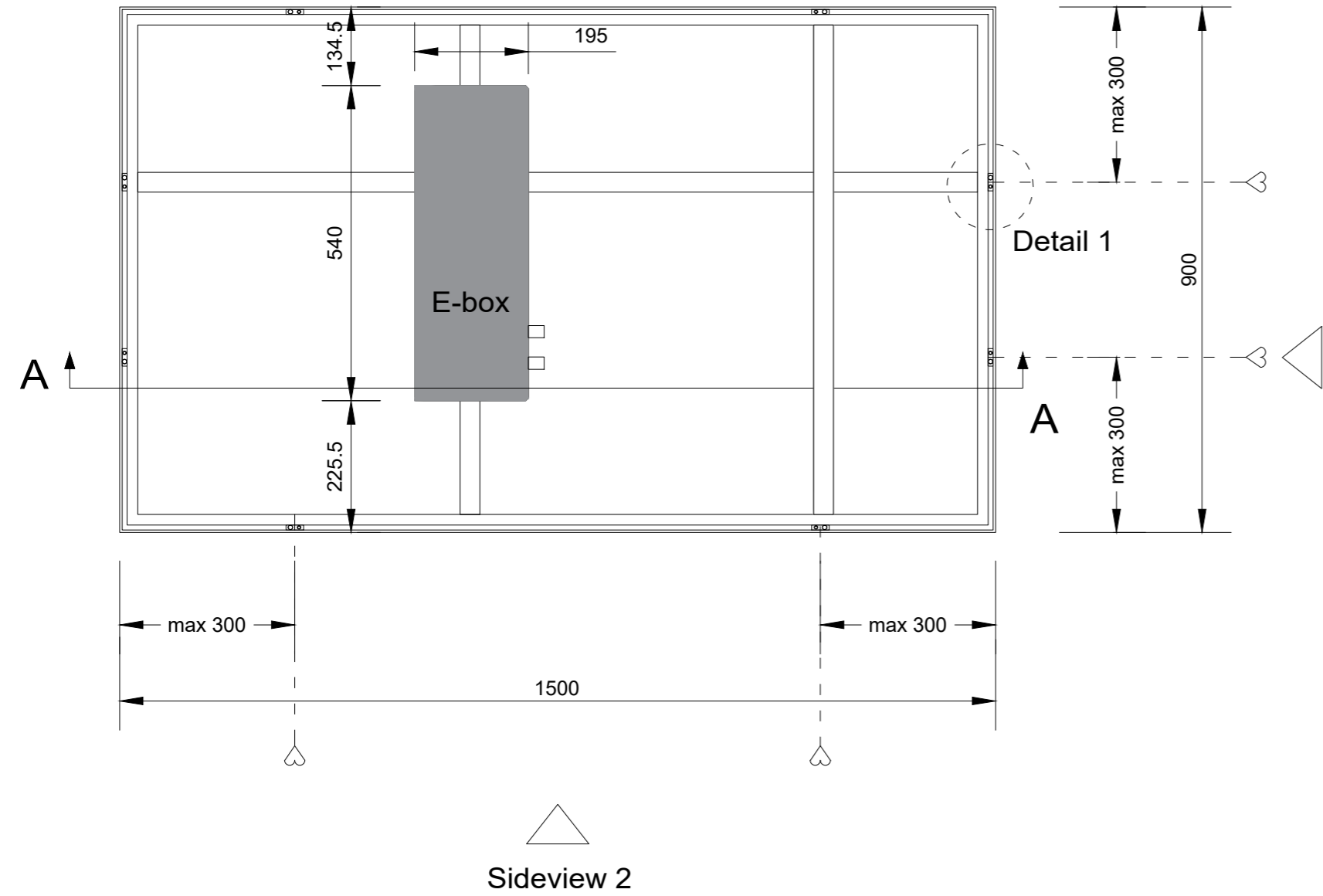

Sideview 1 - mounting position (1:10)

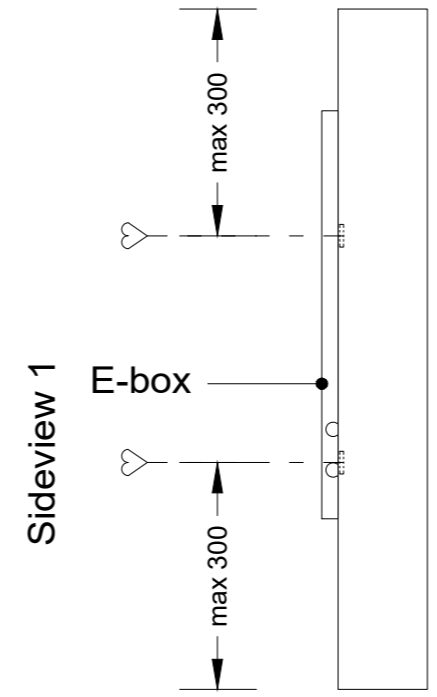

Sideview 2 - mounting position (1:10)

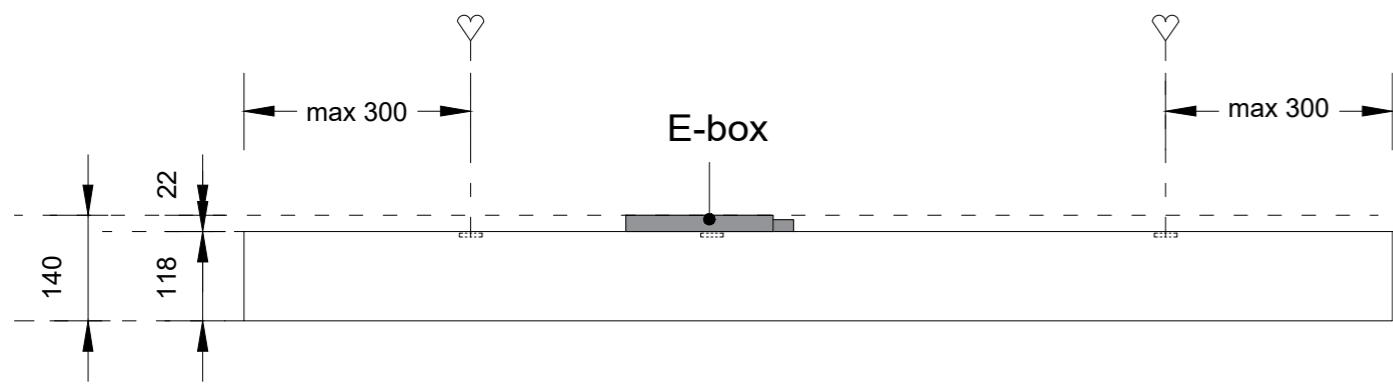

Section A-A (1:10)

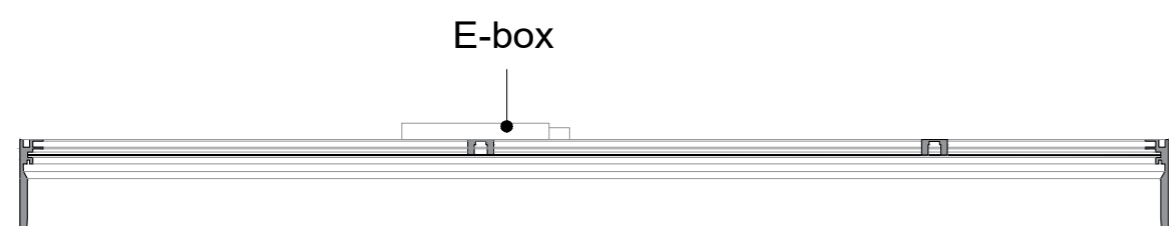

Detail 1 (1:1)

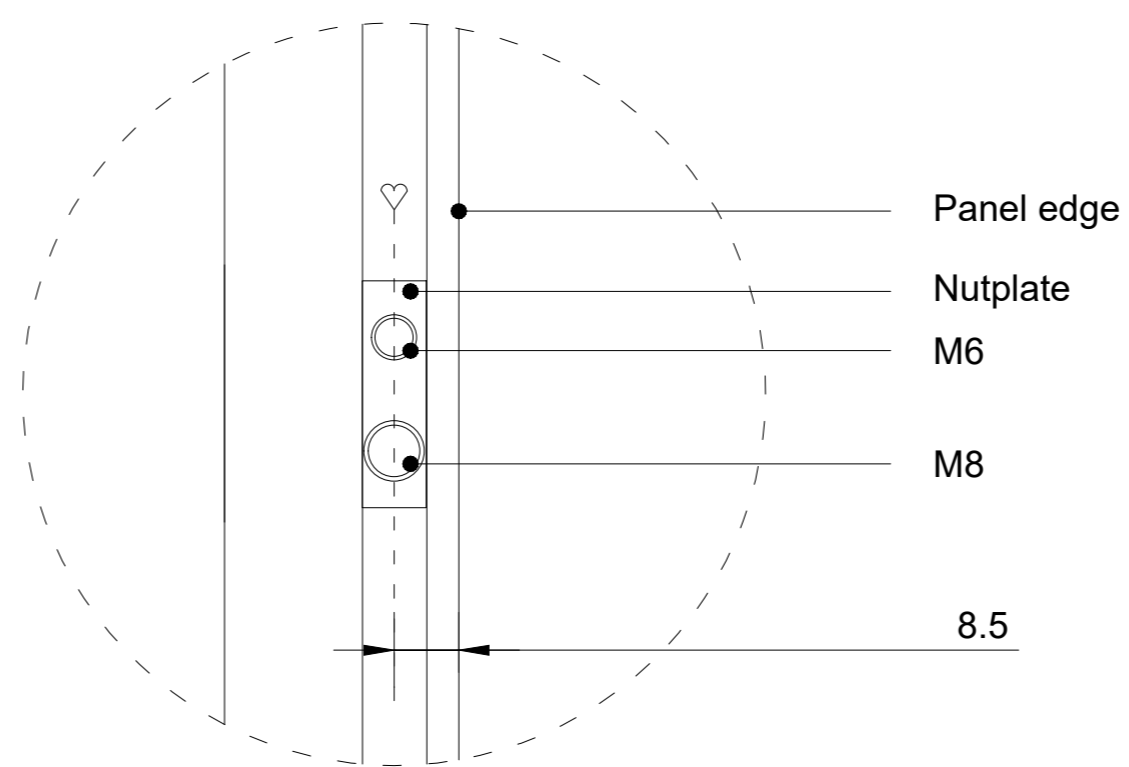

Backview (1:10)

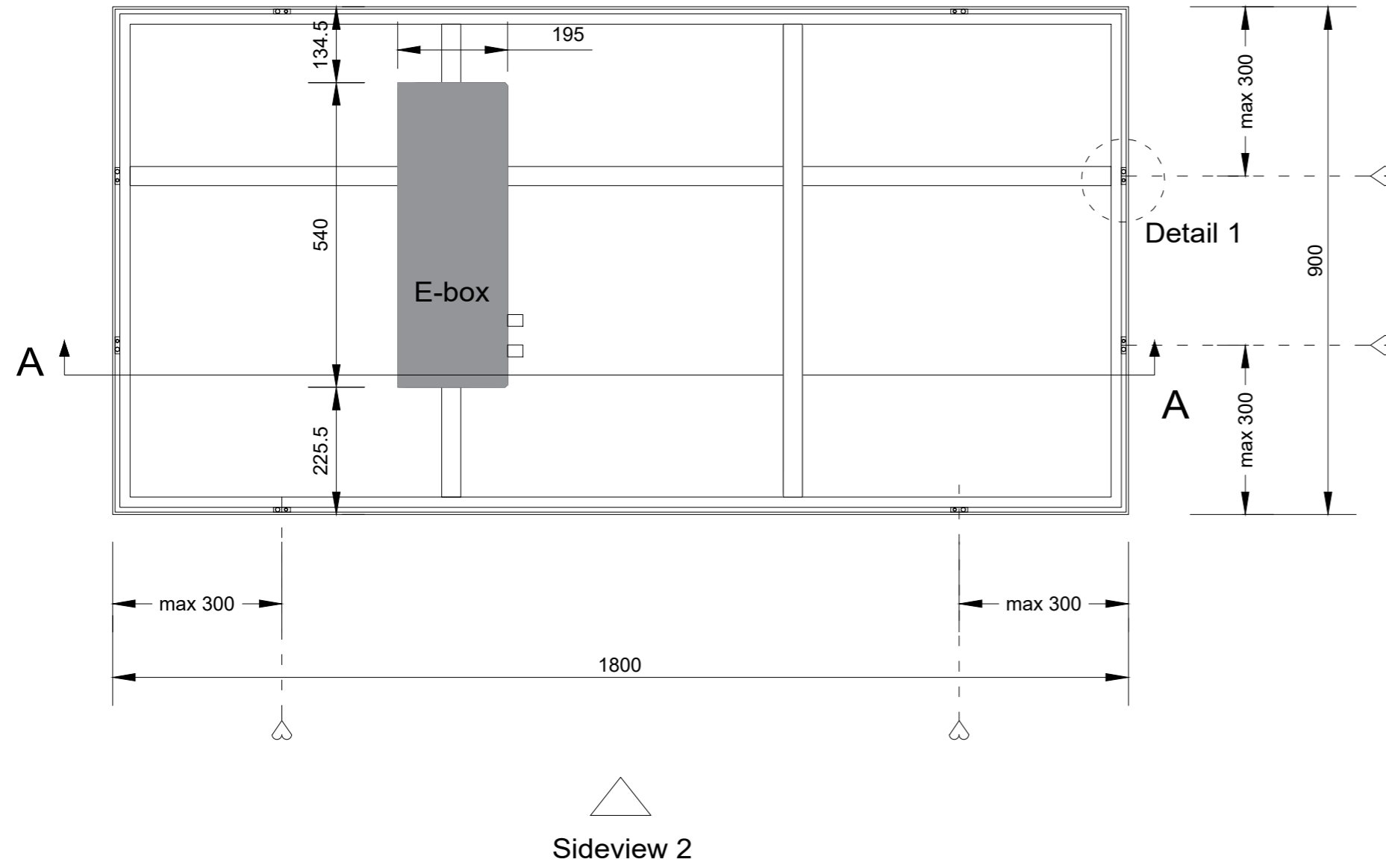

Sideview 1 - mounting position (1:10)

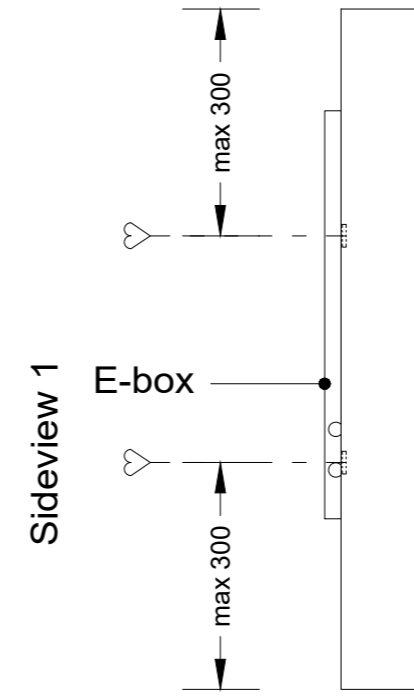

Sideview 2 - mounting position (1:10)

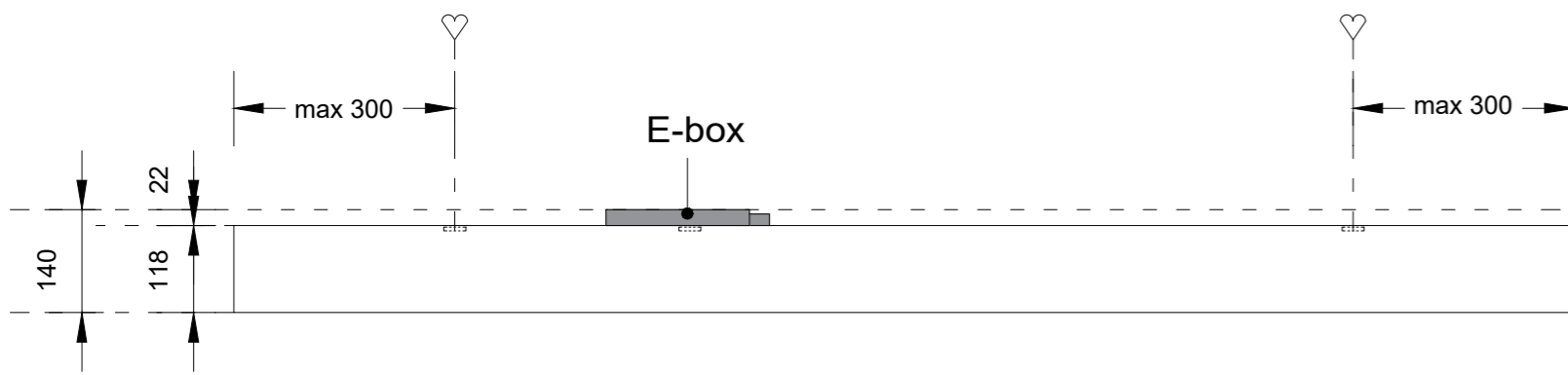

Section A-A (1:10)



Detail 1 (1:1)

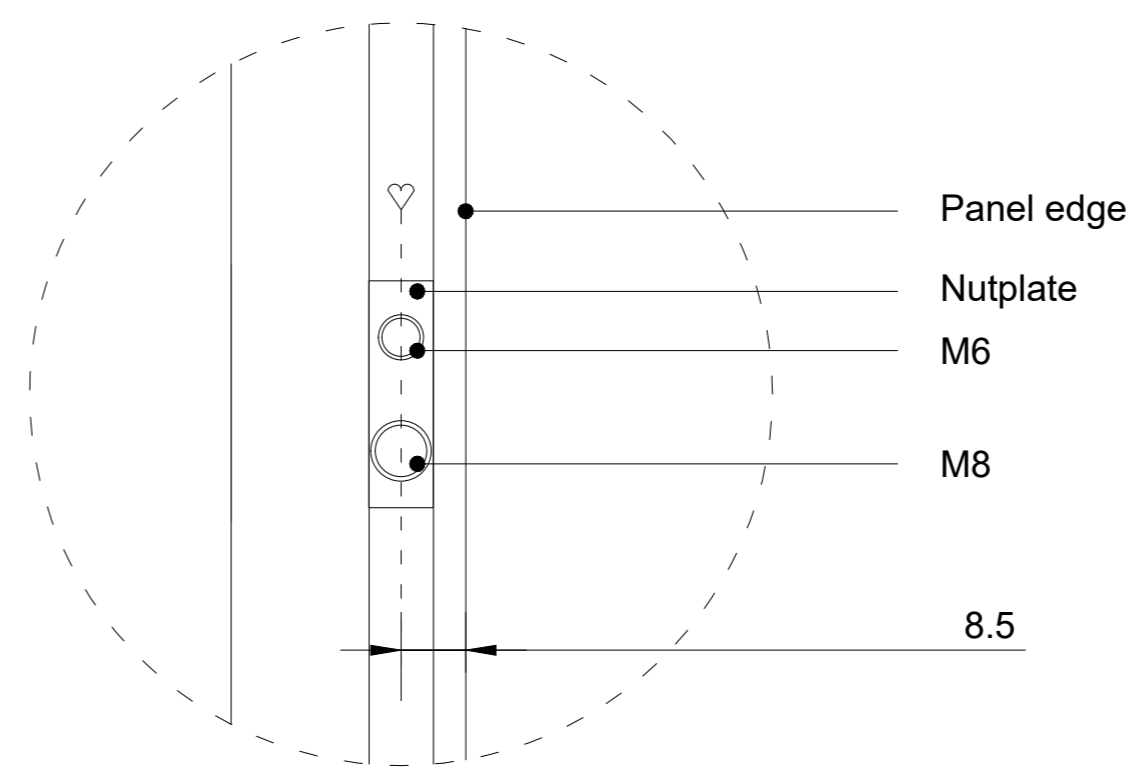

Backview (1:10)

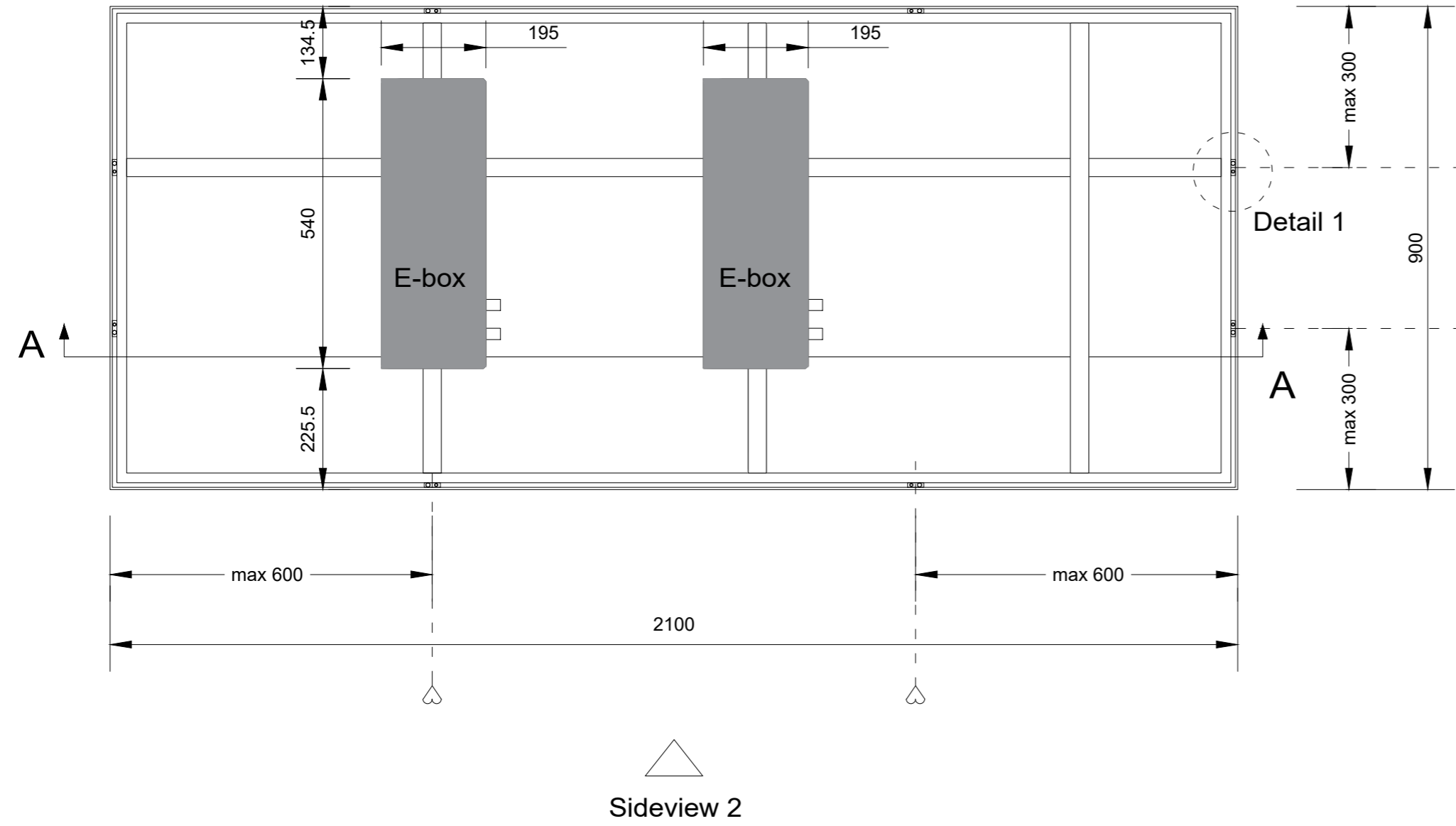

Sideview 1 - mounting position (1:10)

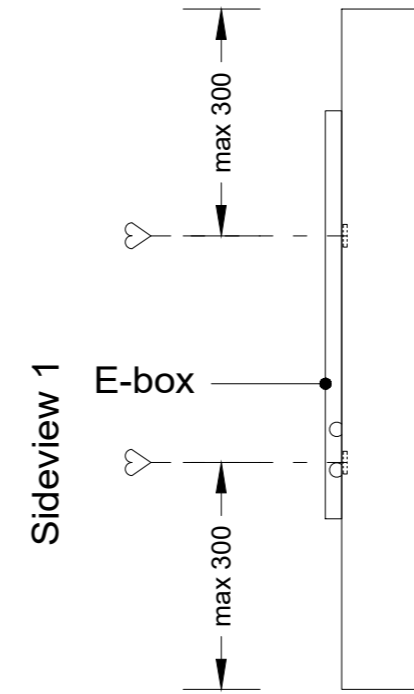

Sideview 2 - mounting position (1:10)

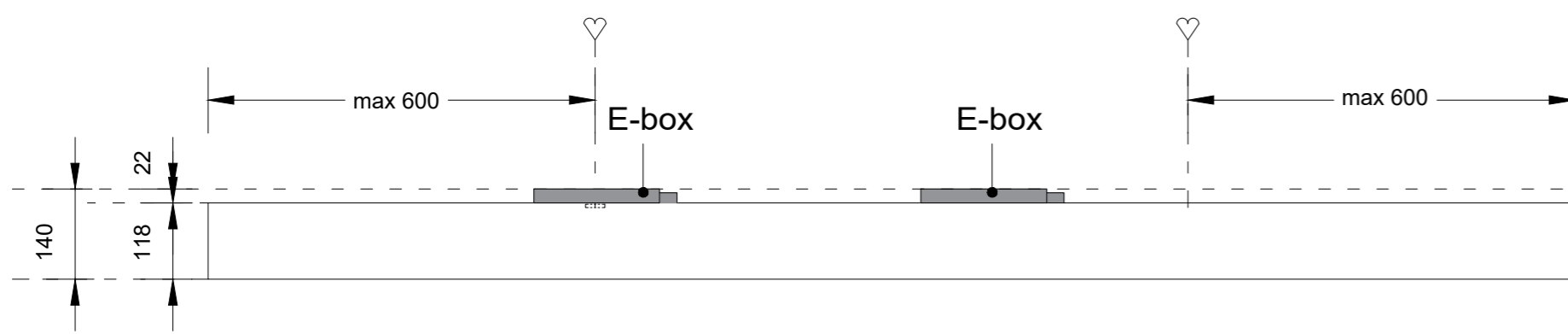

Section A-A (1:10)

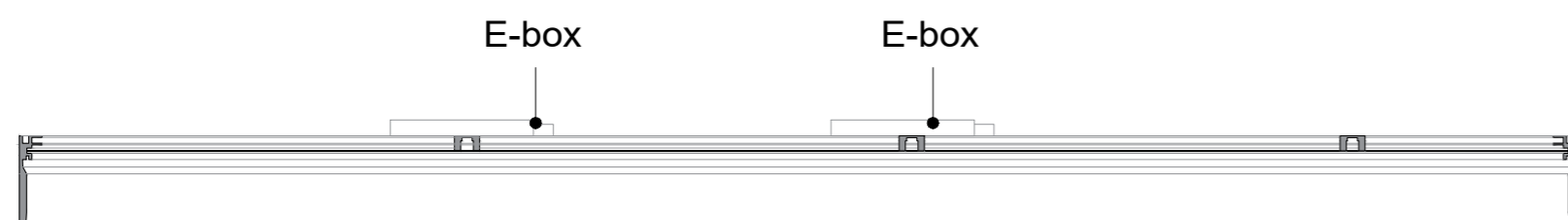

Detail 1 (1:1)

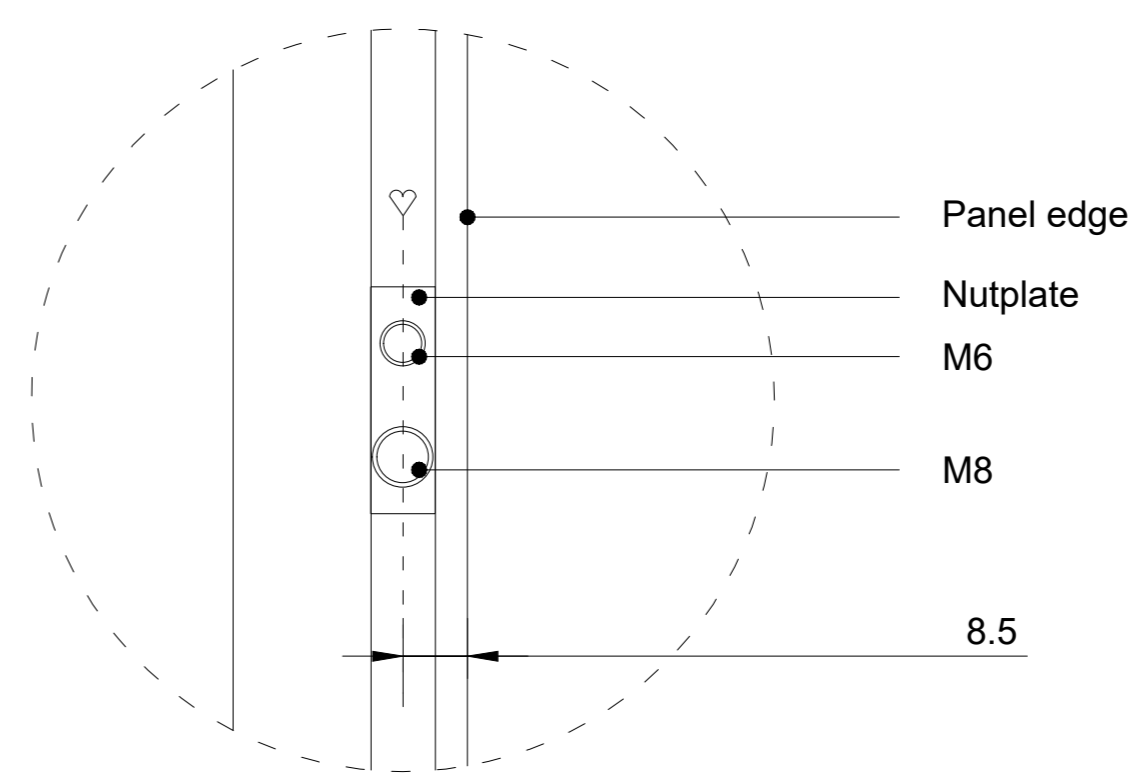

Backview (1:10)

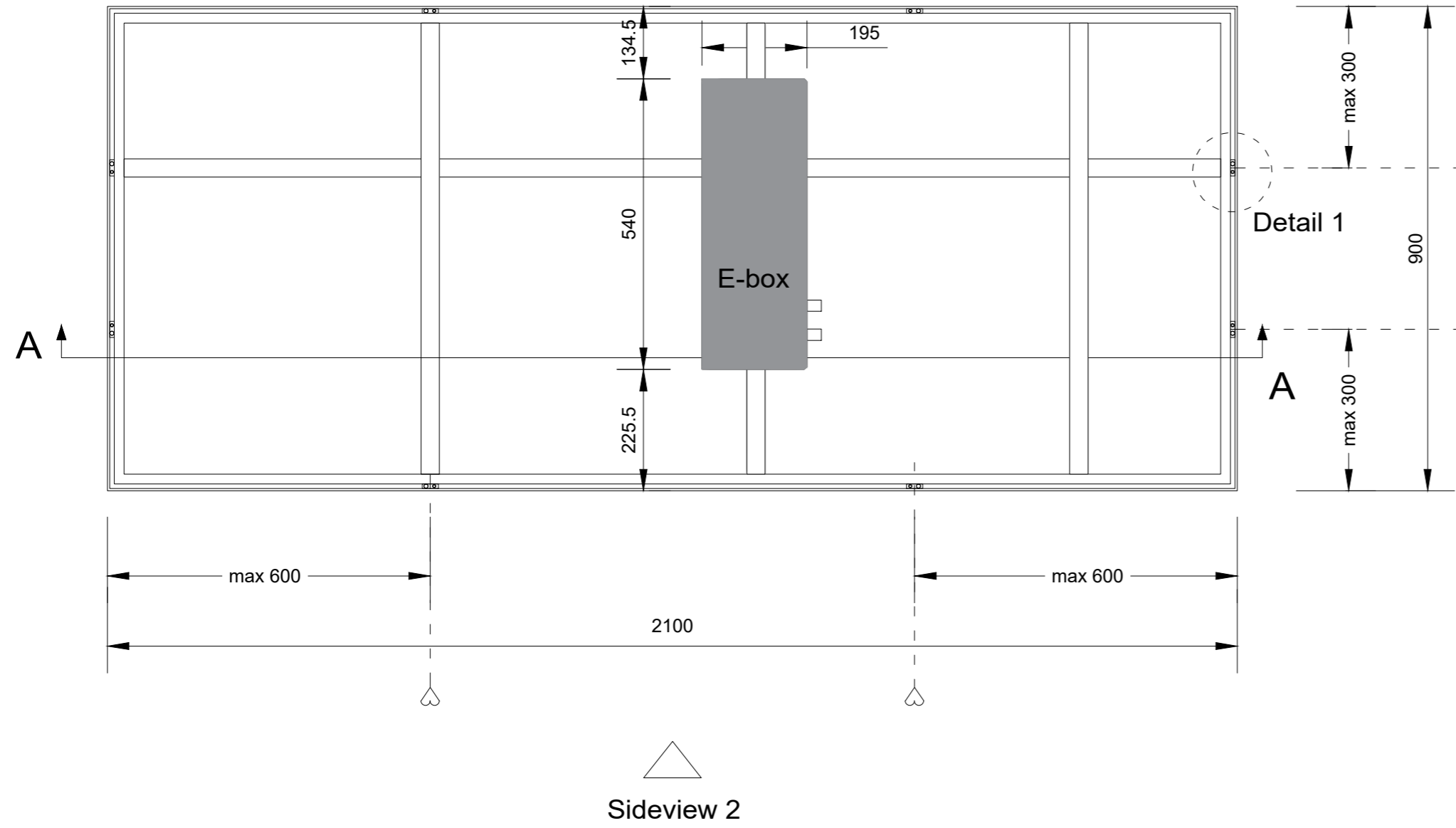

Sideview 1 - mounting position (1:10)

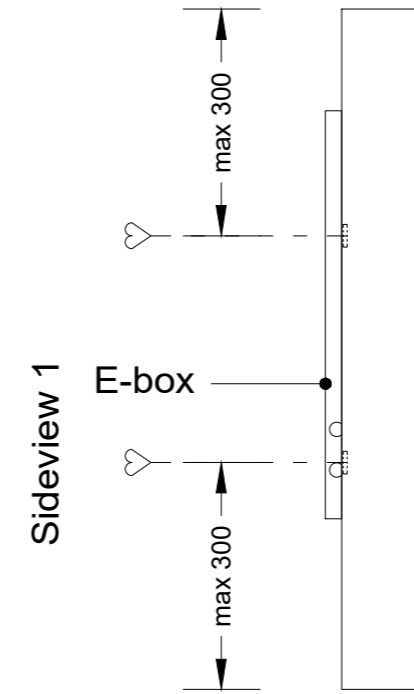

Sideview 2 - mounting position (1:10)

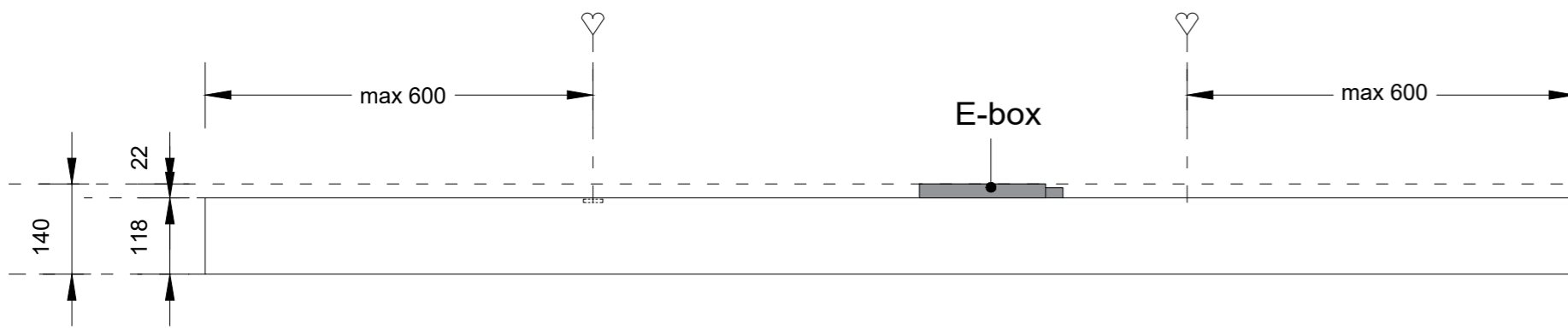

Section A-A (1:10)

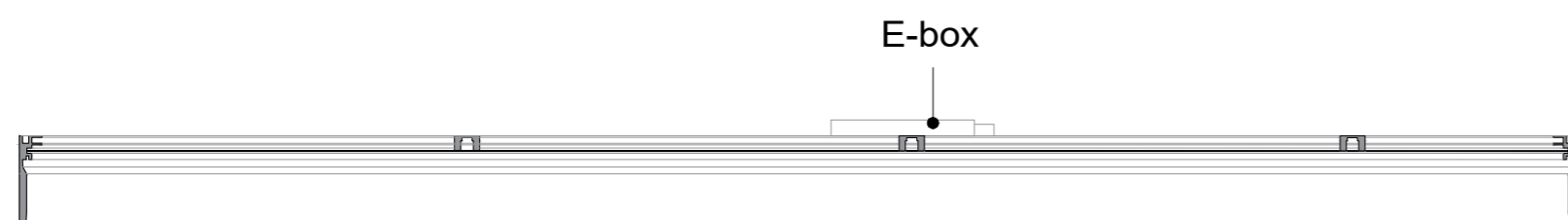

Detail 1 (1:1)

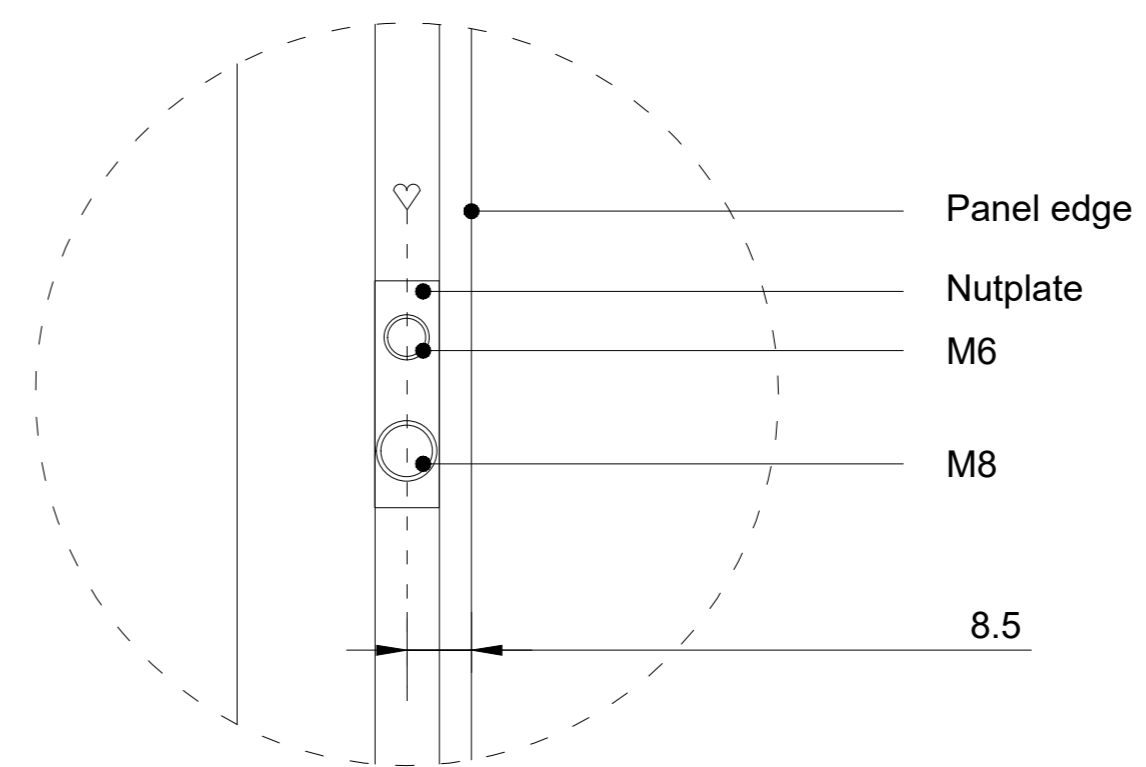

Backview (1:10)

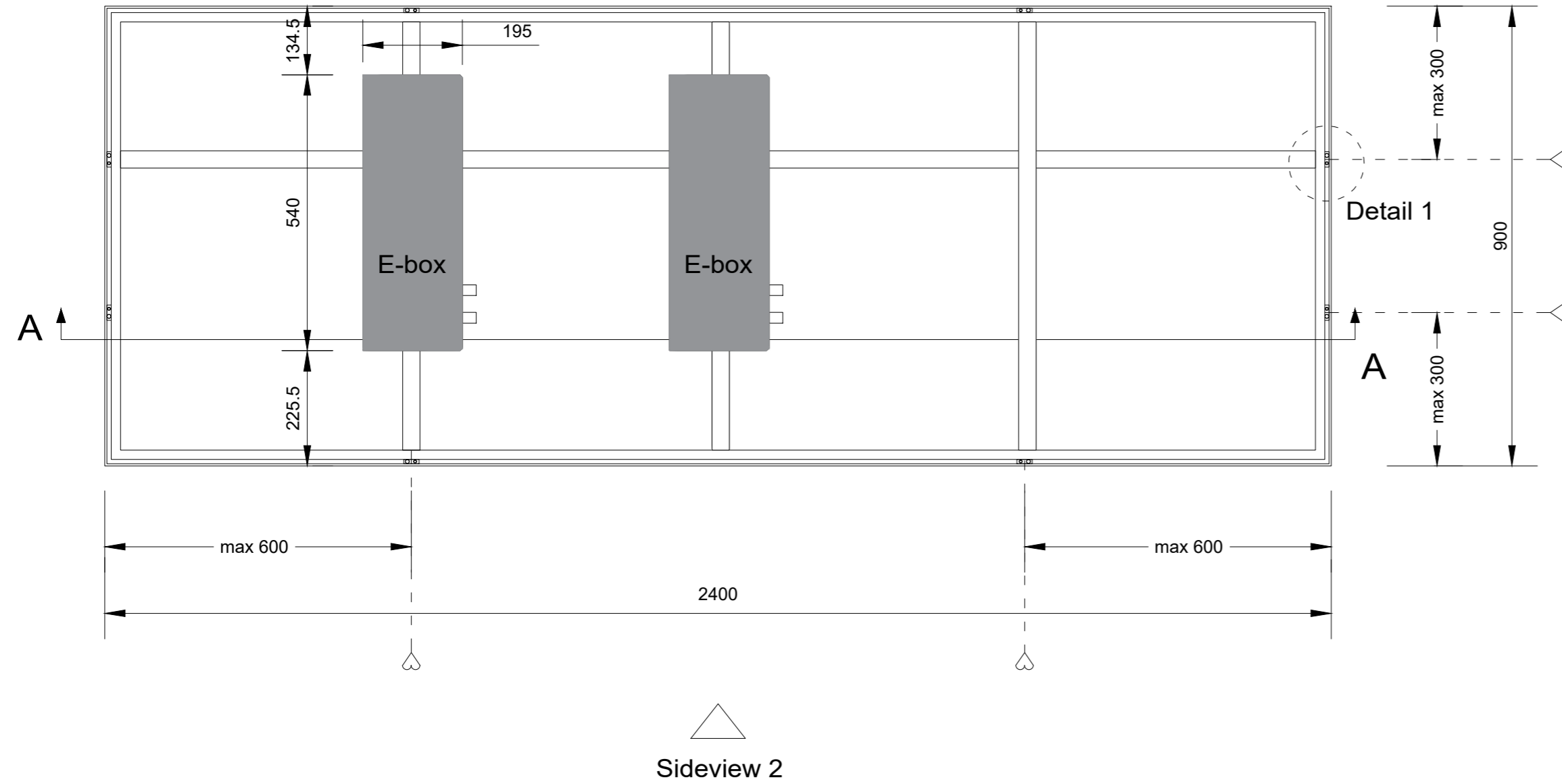

Sideview 1 - mounting position (1:10)

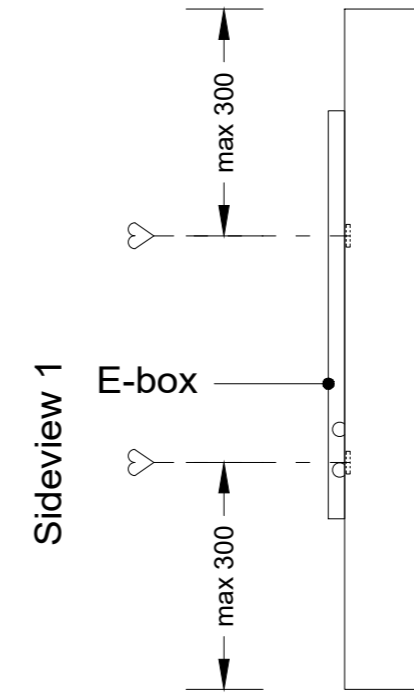

Sideview 2 - mounting position (1:10)

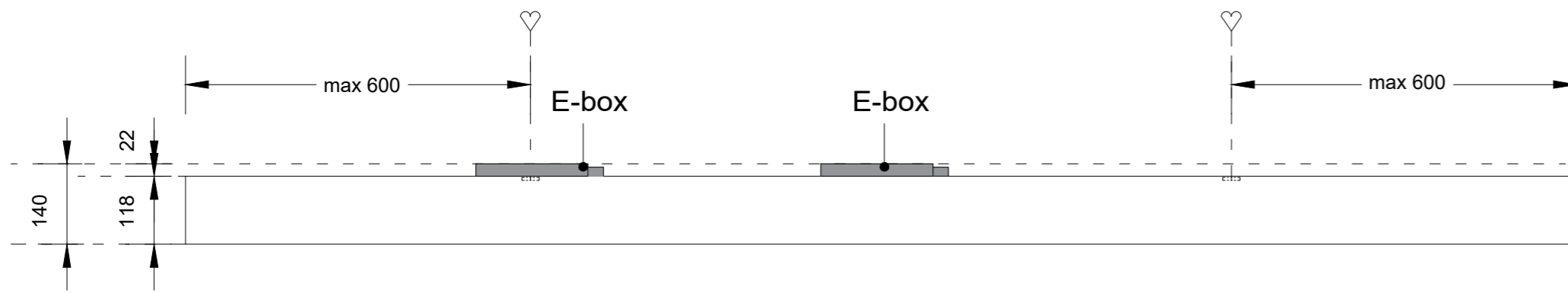

Section A-A (1:10)

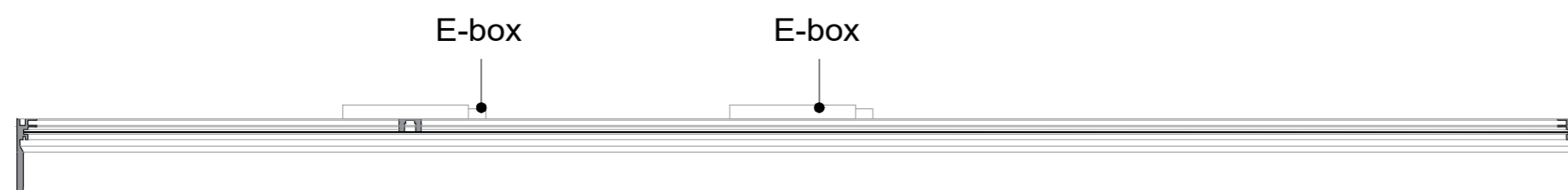

Detail 1 (1:1)

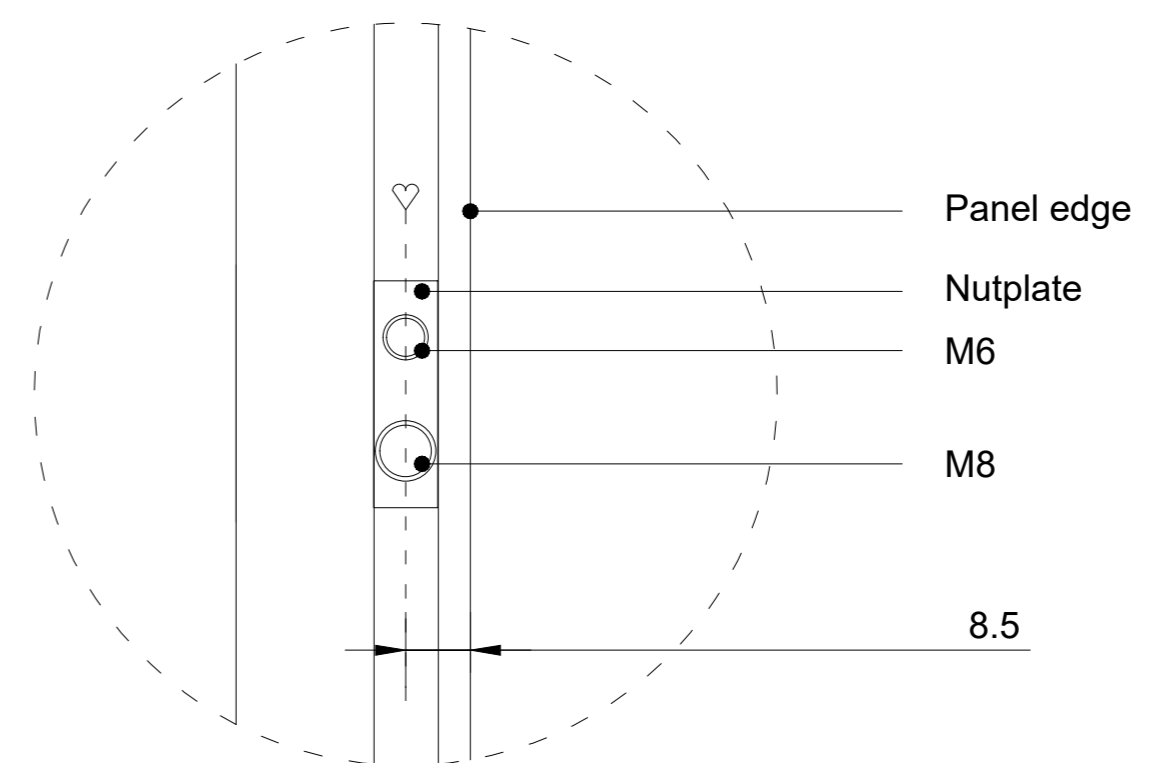

Backview (1:10)



Sideview 1 - mounting position (1:10)

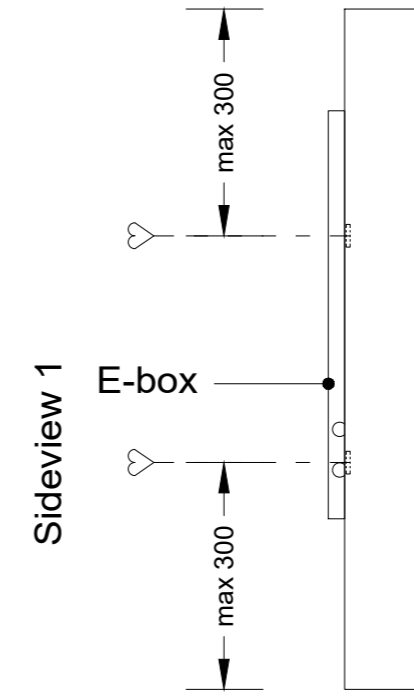

Sideview 2 - mounting position (1:10)

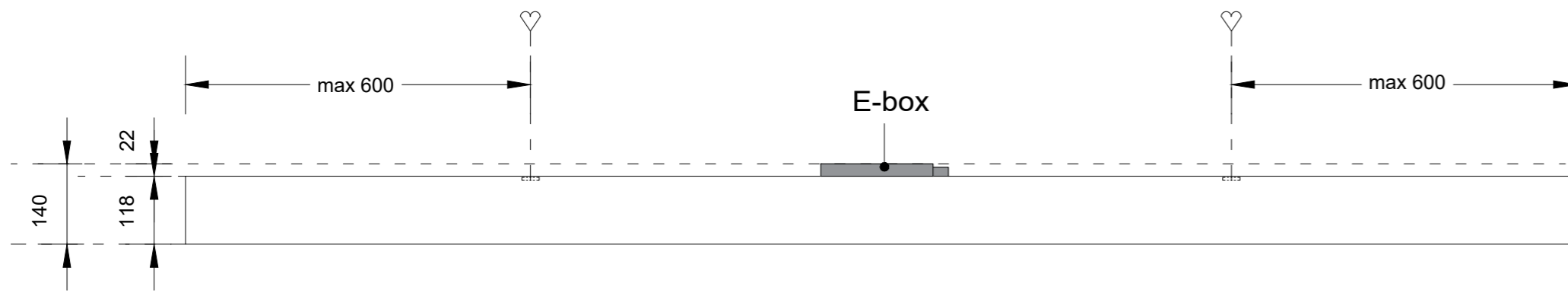

Section A-A (1:10)

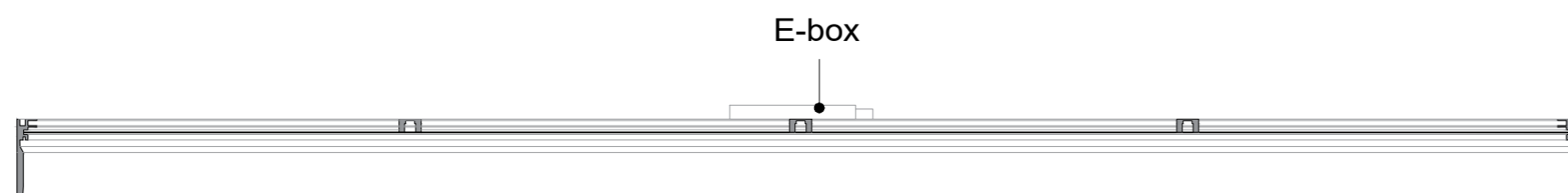

Detail 1 (1:1)

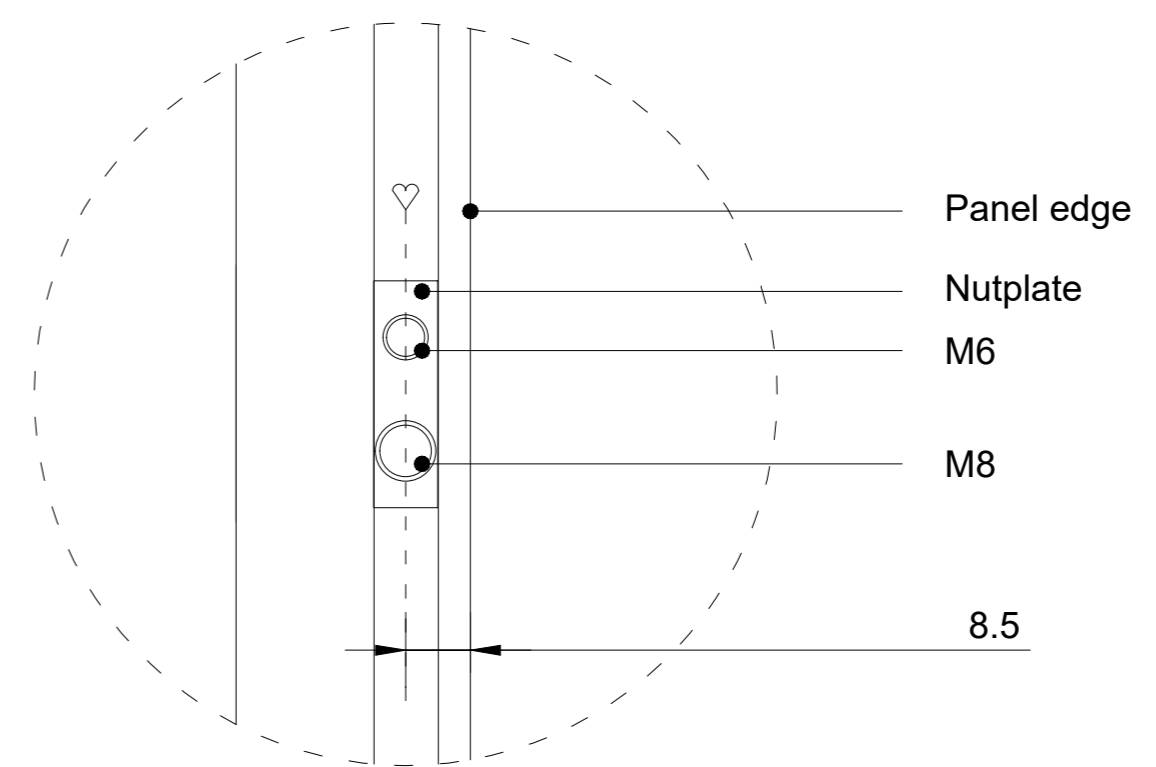



Backview (1:10)

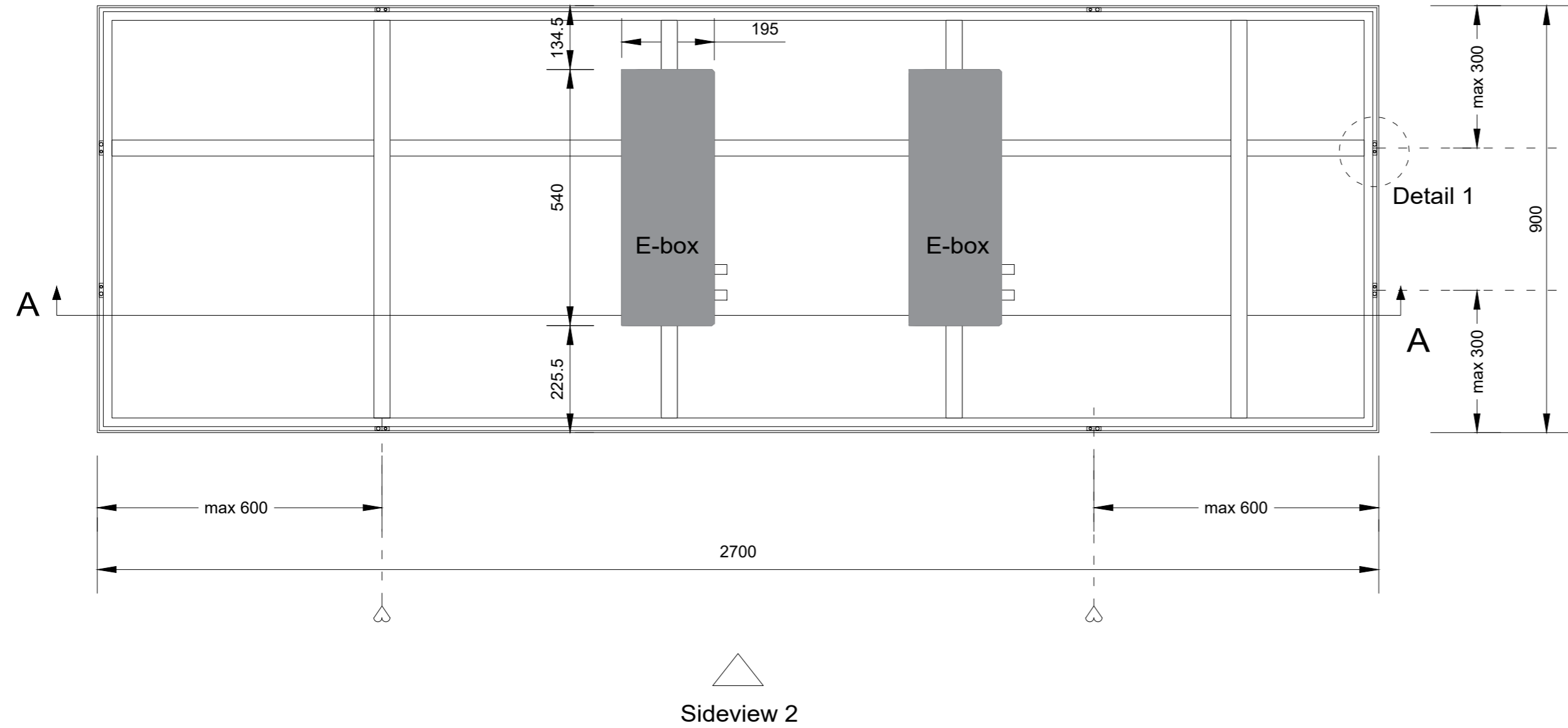

Sideview 1 - mounting position (1:10)

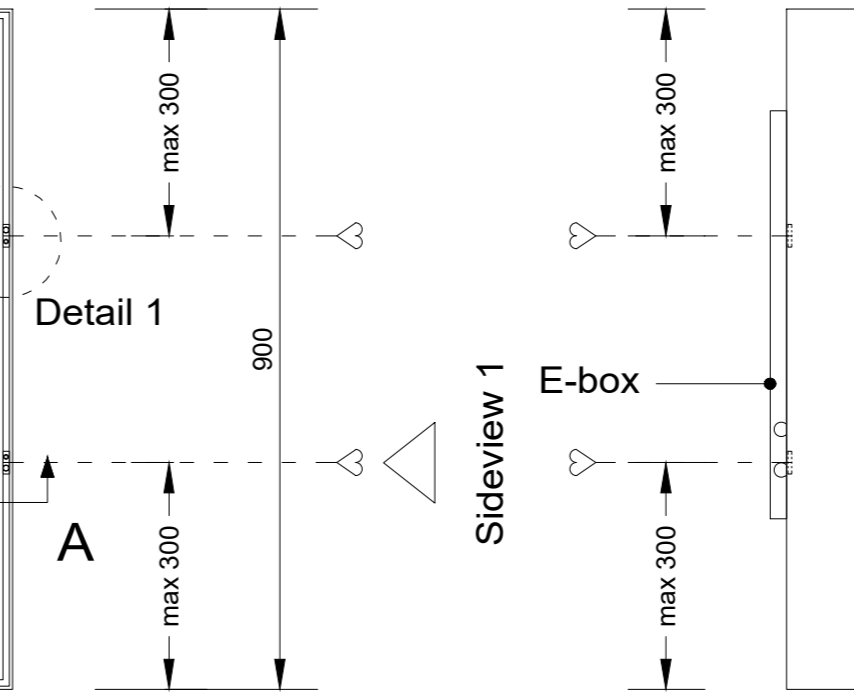

Sideview 2 - mounting position (1:10)

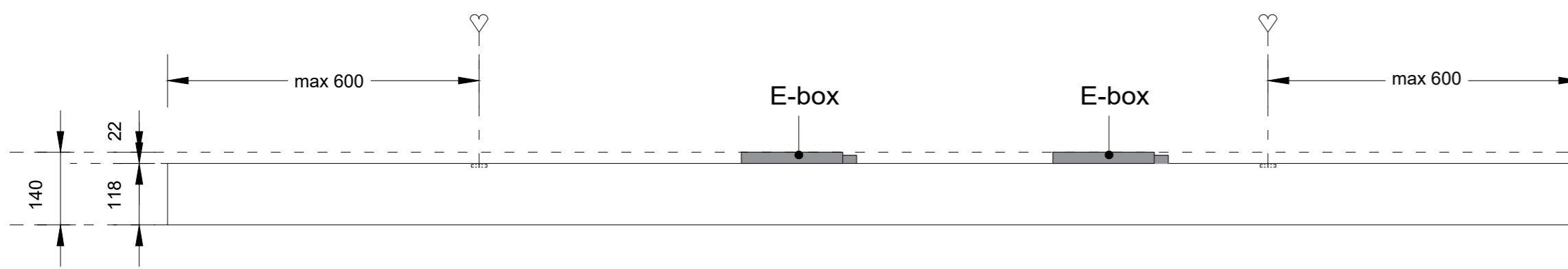

Section A-A (1:10)

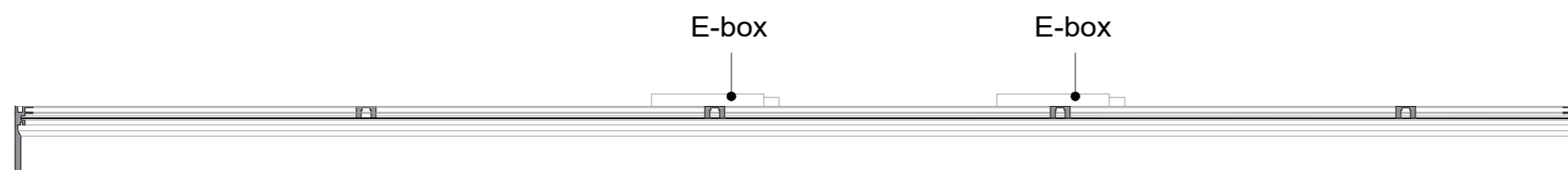

Detail 1 (1:1)

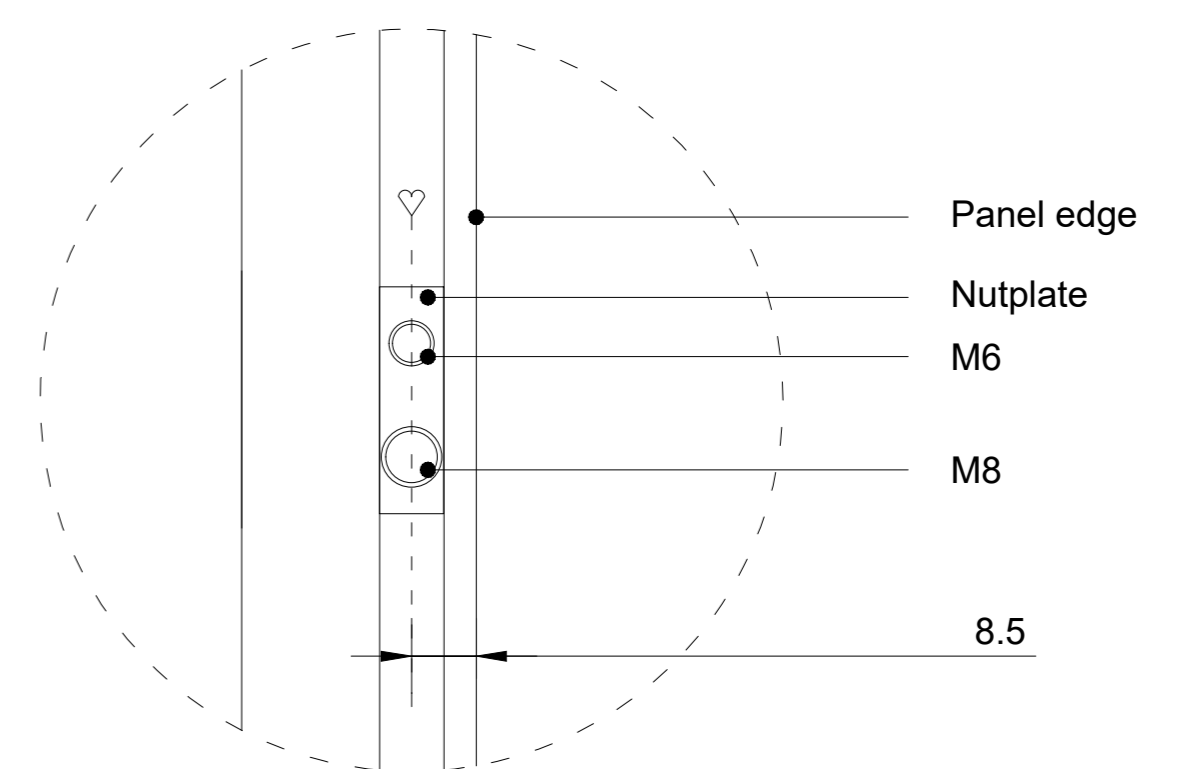

Backview (1:10)

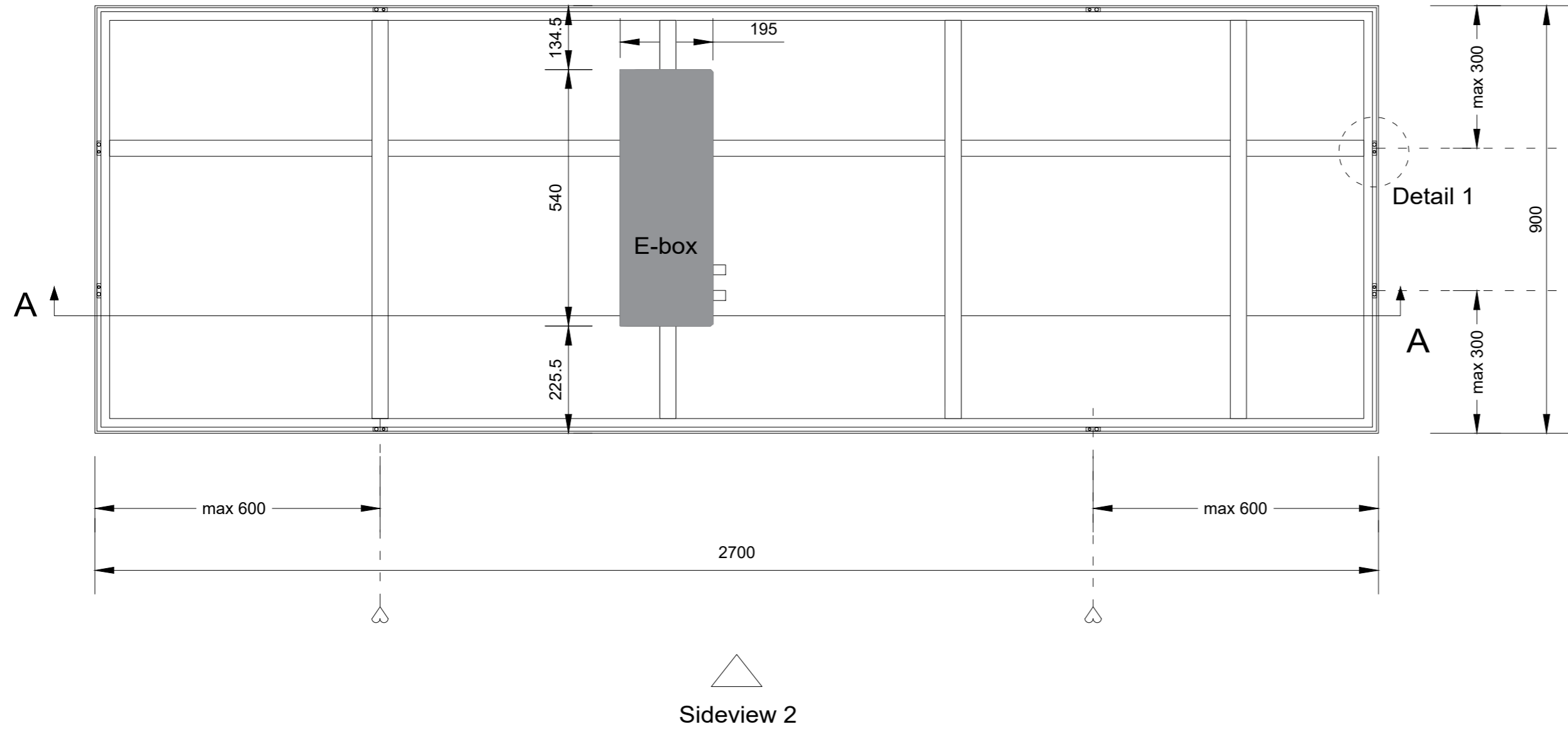

Sideview 1 - mounting position (1:10)

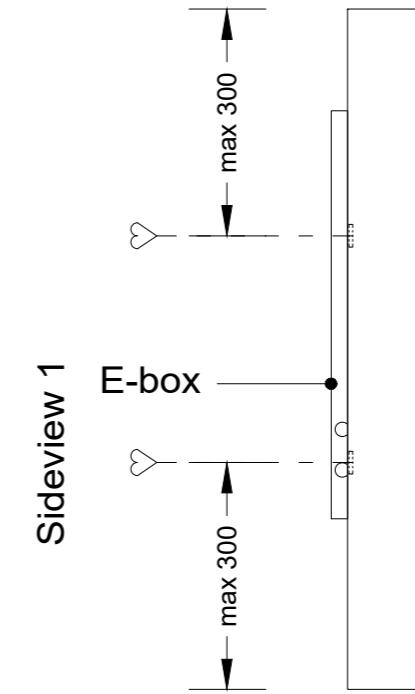

Sideview 2 - mounting position (1:10)

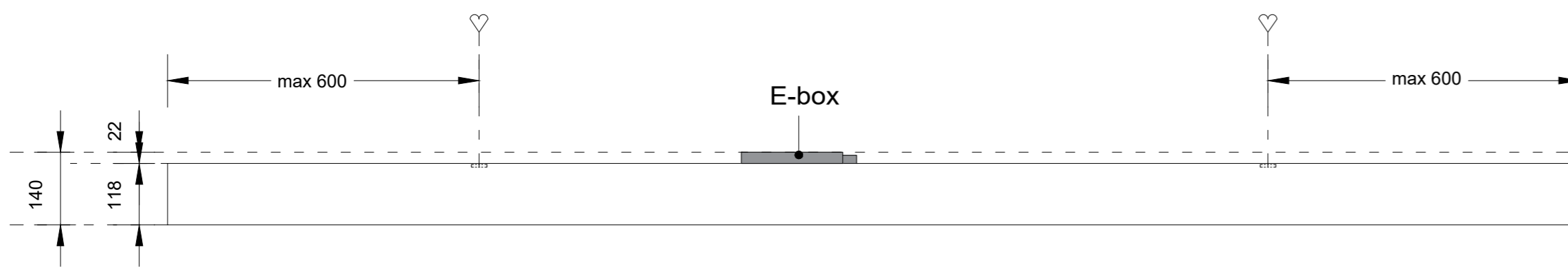

Section A-A (1:10)

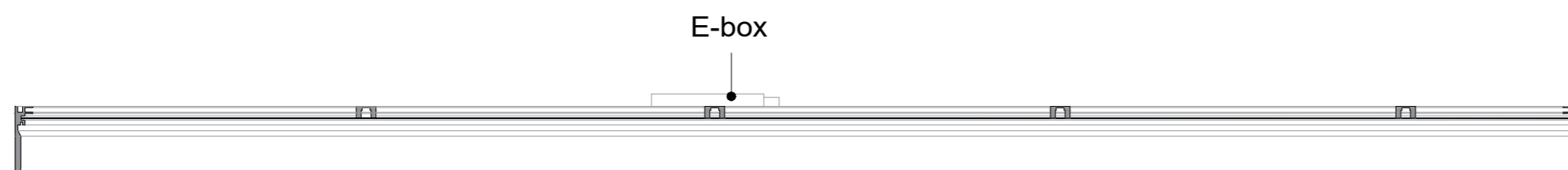

Detail 1 (1:1)

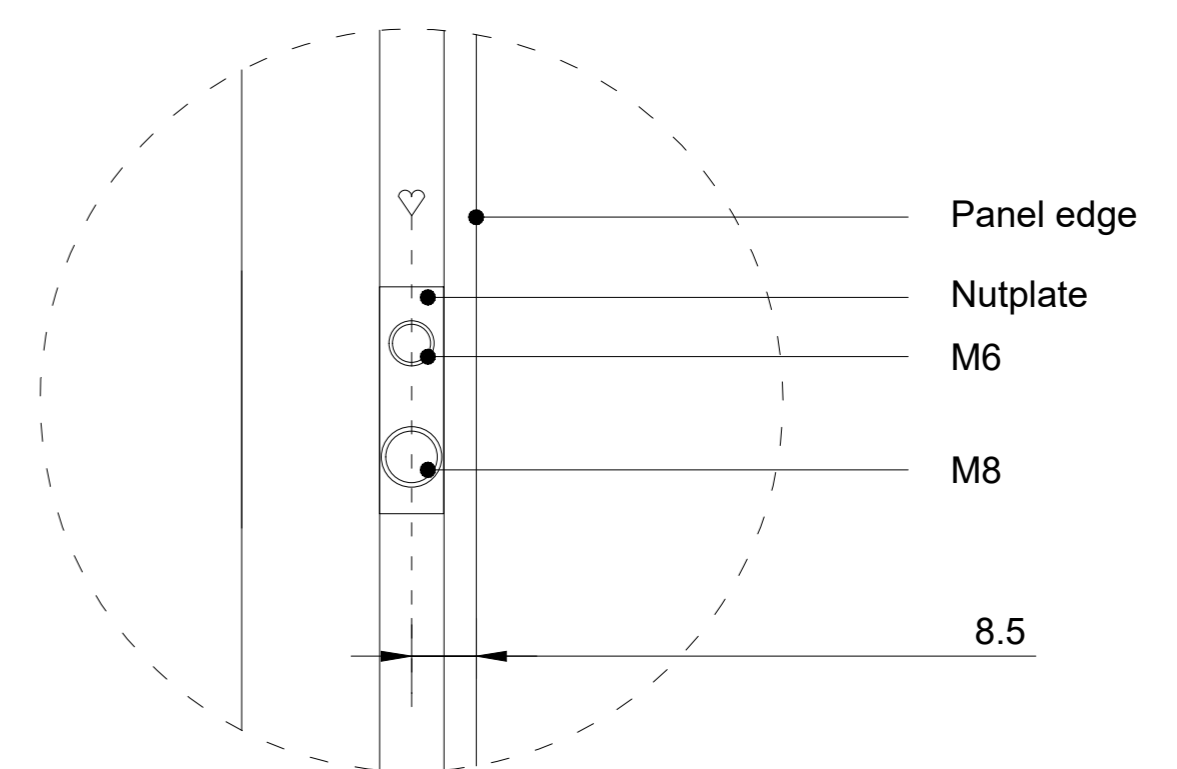

Backview (1:10)

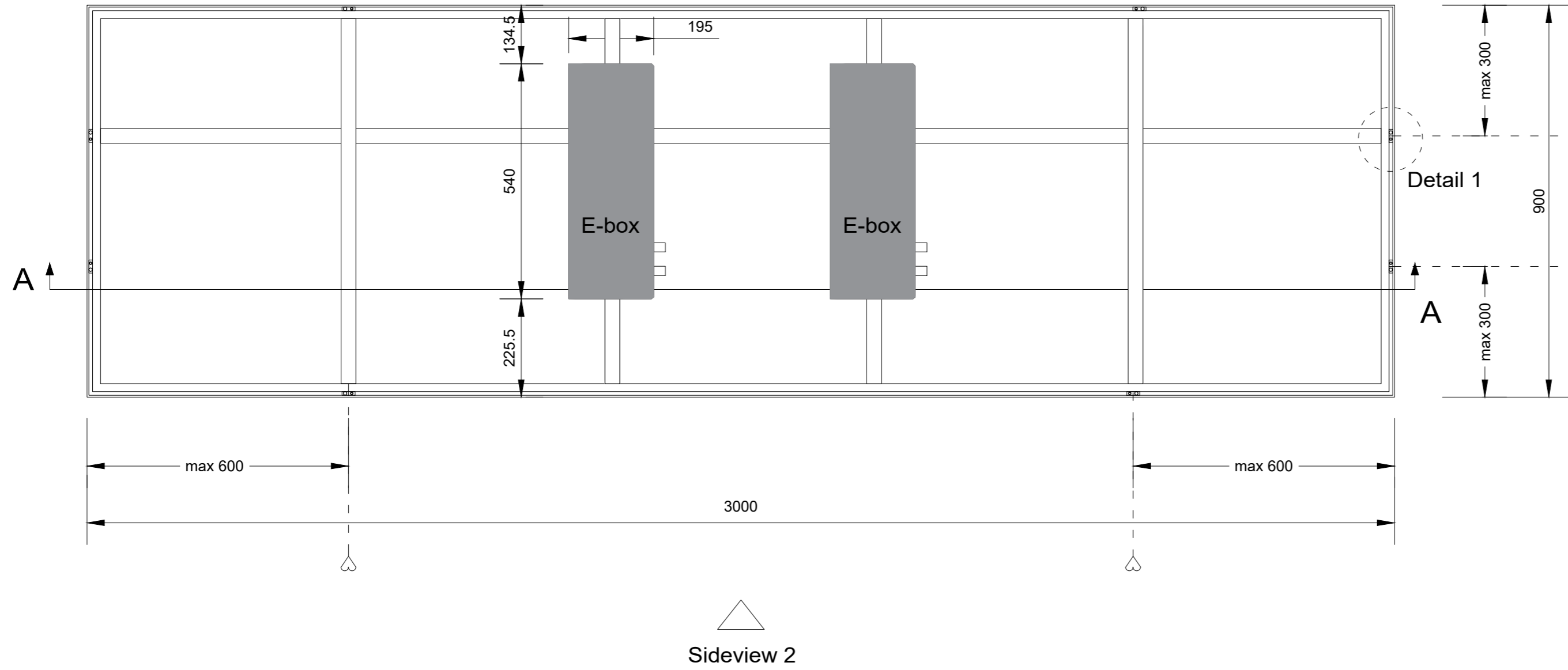

Sideview 1 - mounting position (1:10)

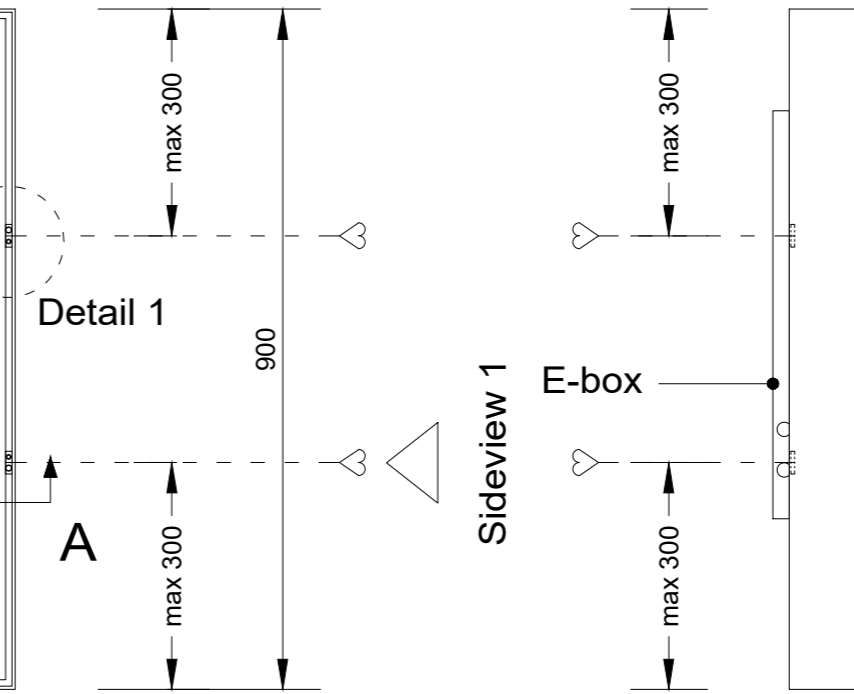

Sideview 2 - mounting position (1:10)

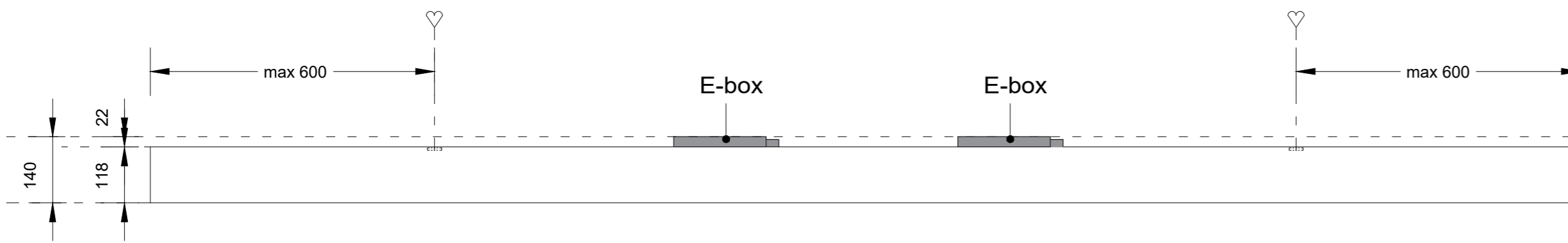

Section A-A (1:10)



Detail 1 (1:1)

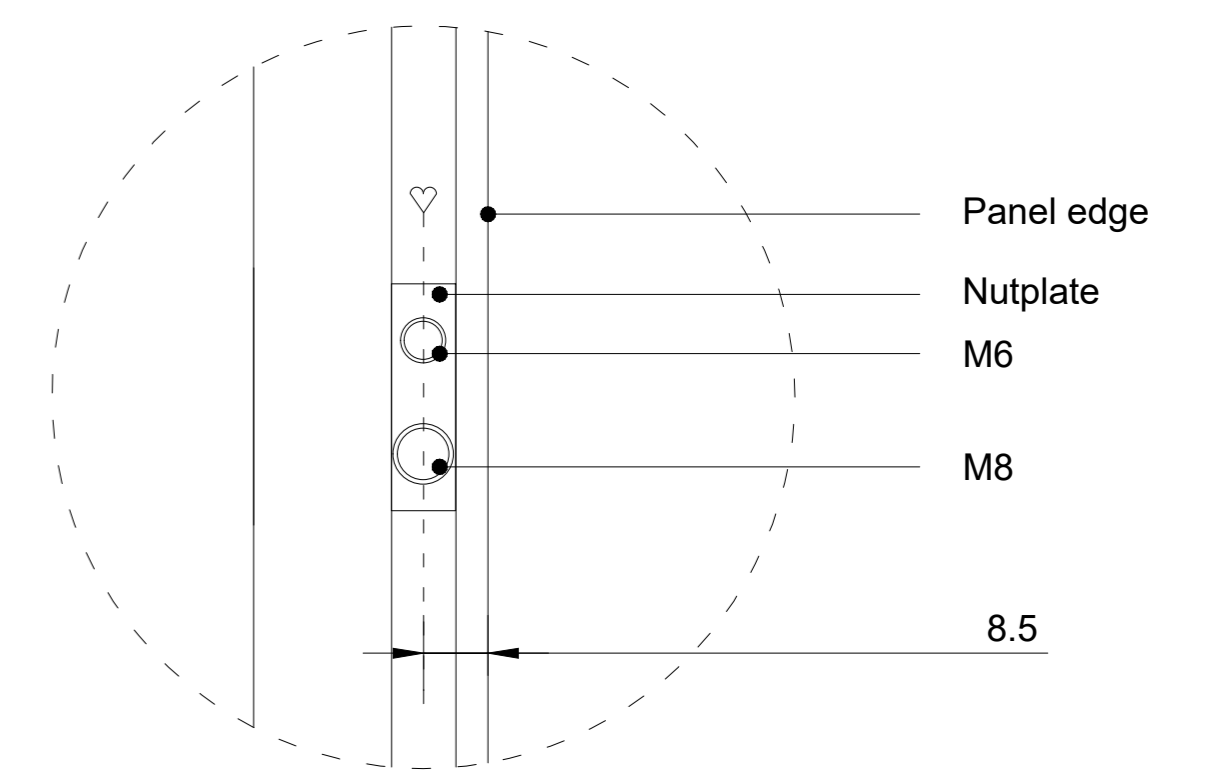

Backview (1:10)

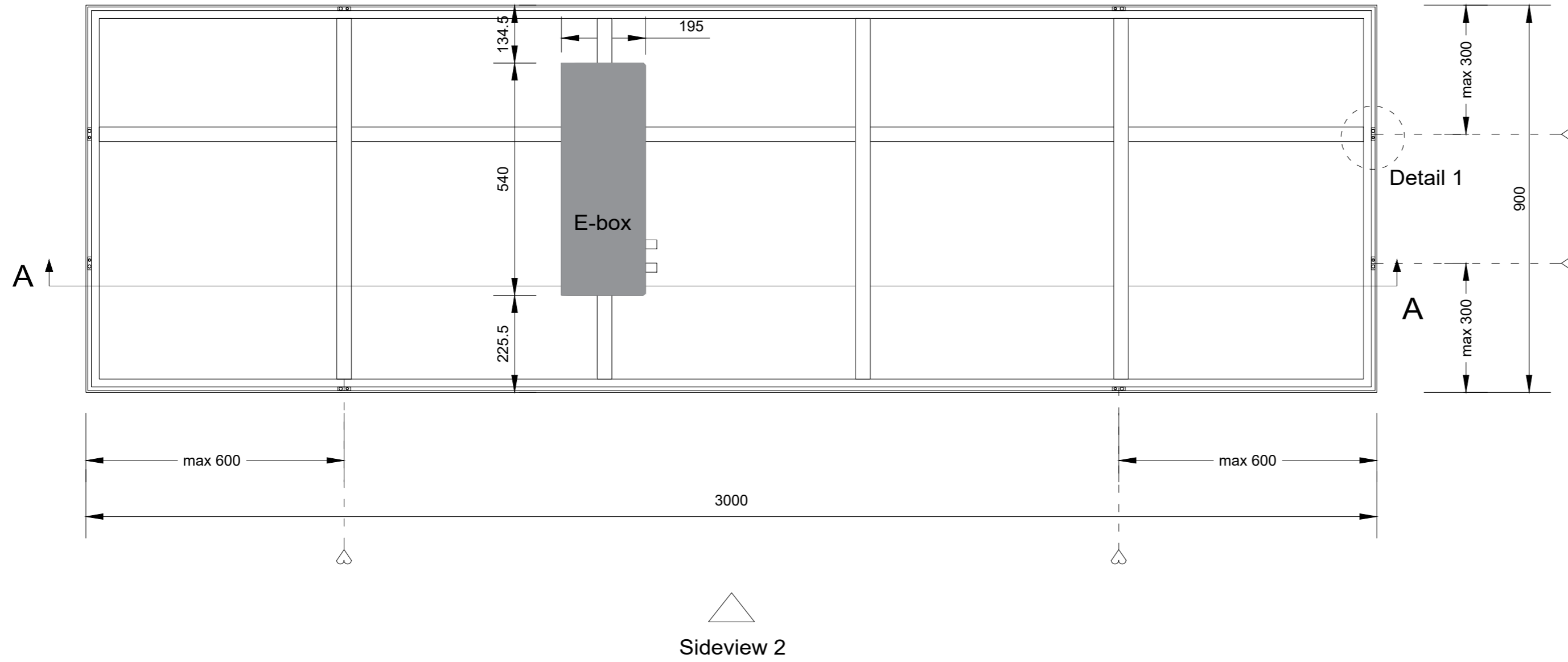

Sideview 1 - mounting position (1:10)

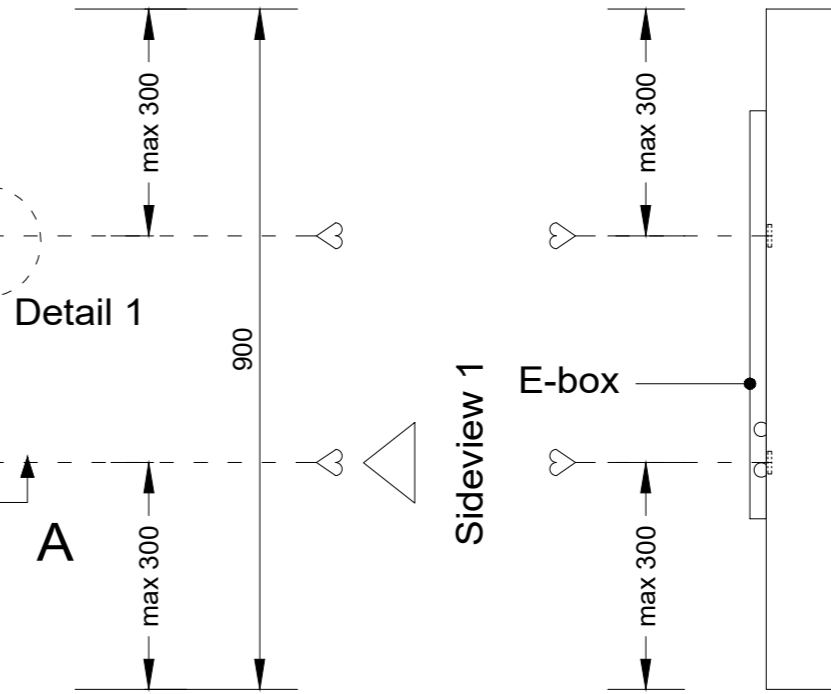

Sideview 2 - mounting position (1:10)

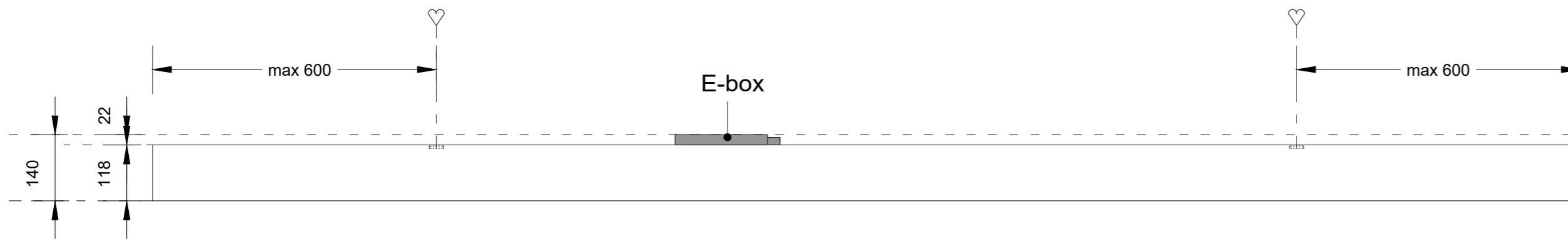

Section A-A (1:10)



Detail 1 (1:1)

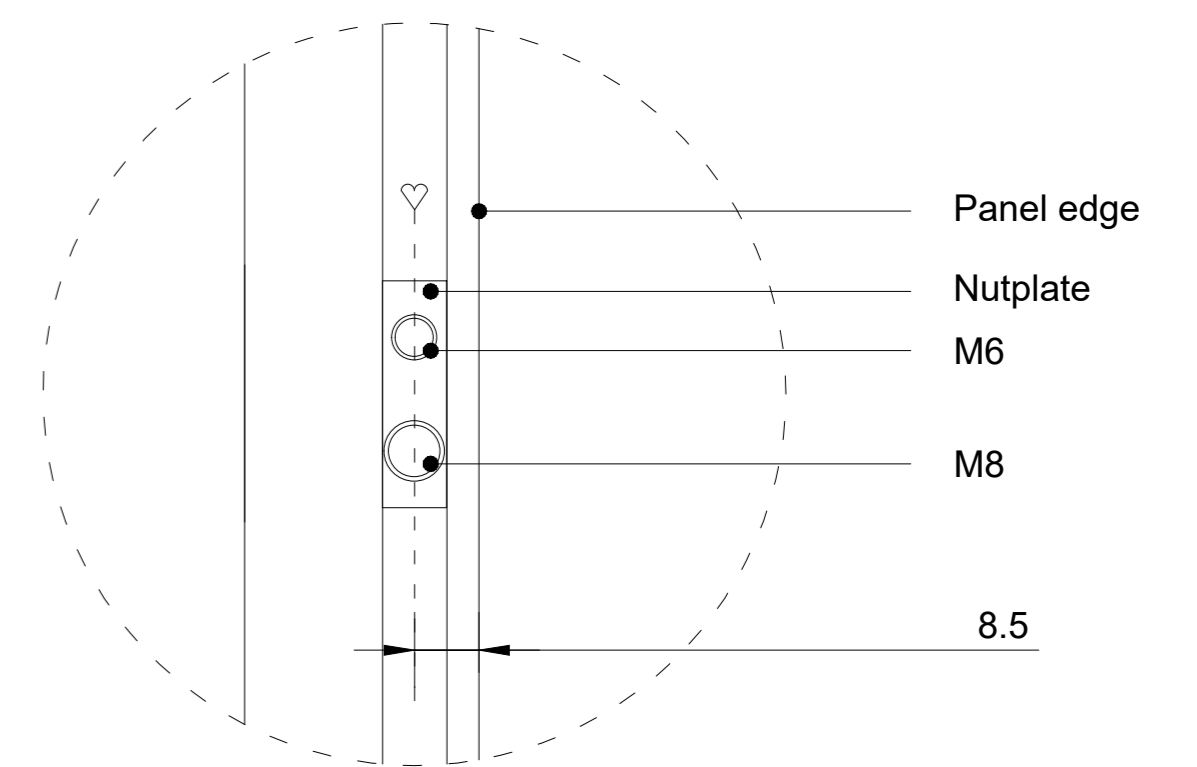

Backview (1:10)

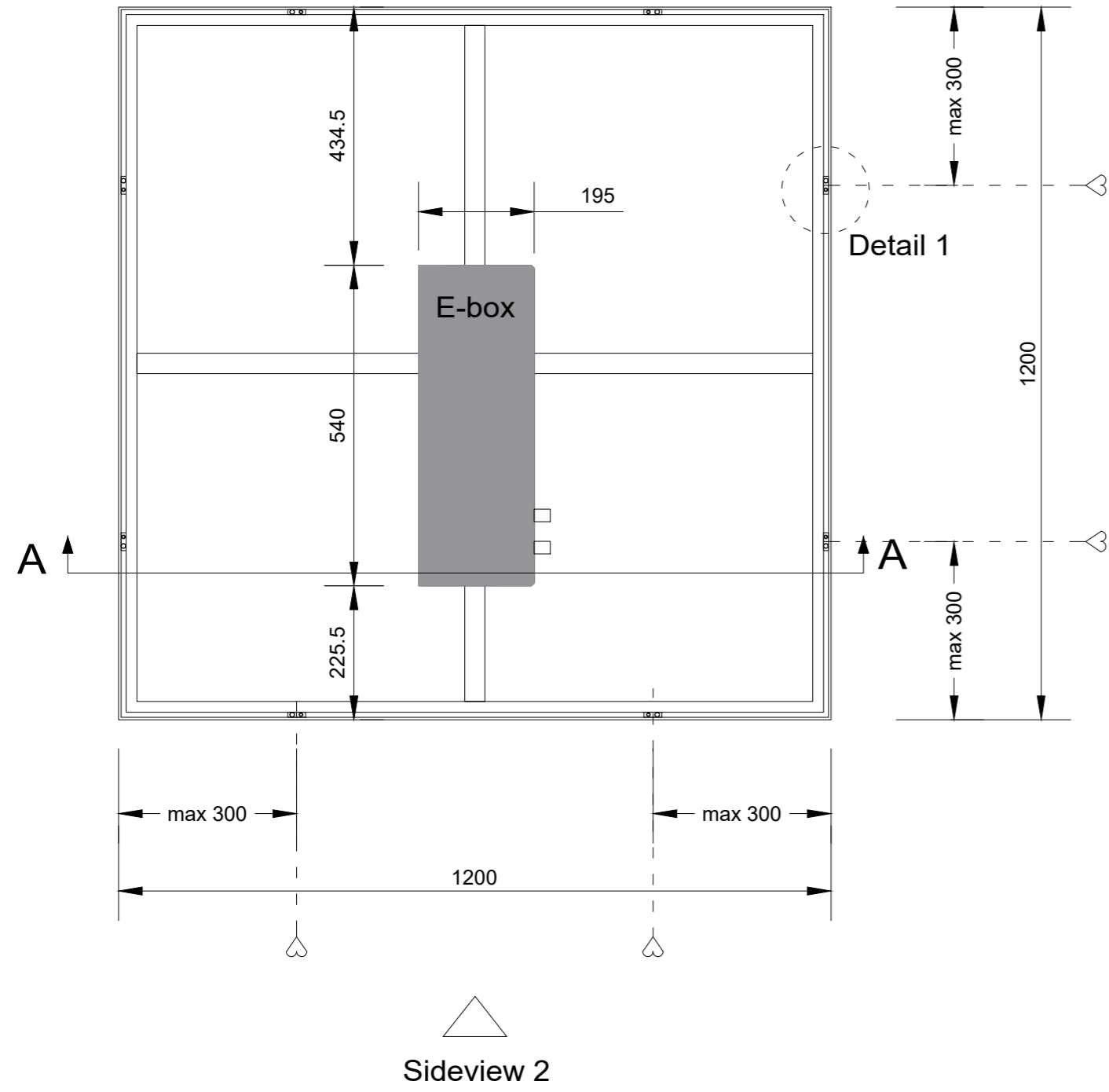

Sideview 1 - mounting position (1:10)

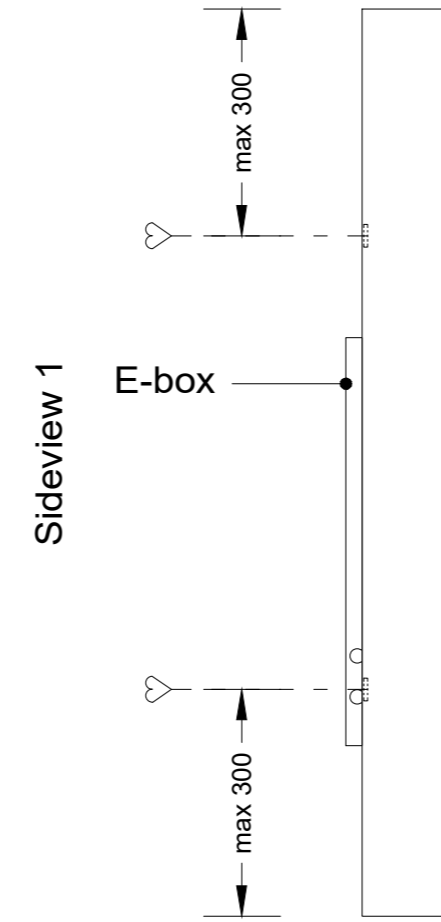

Sideview 2 - mounting position (1:10)

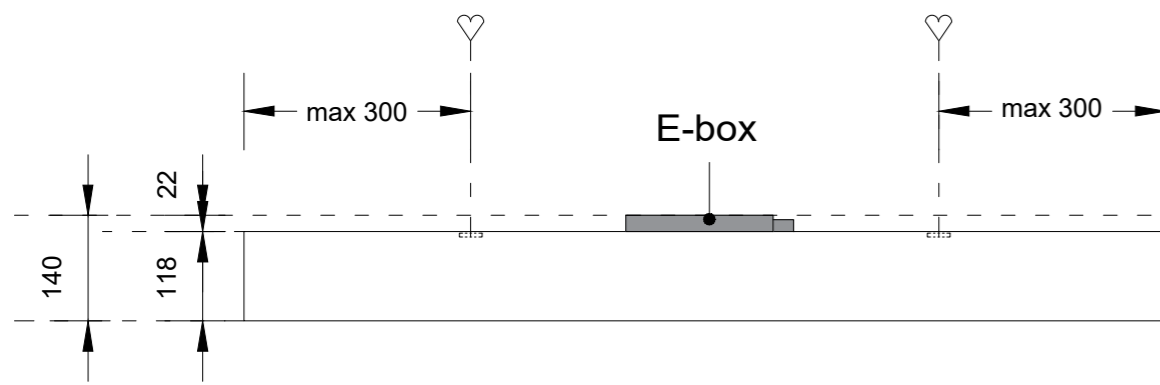

Section A-A (1:10)

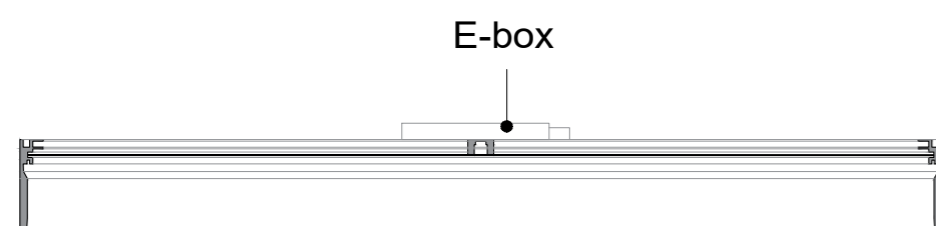

Detail 1 (1:1)

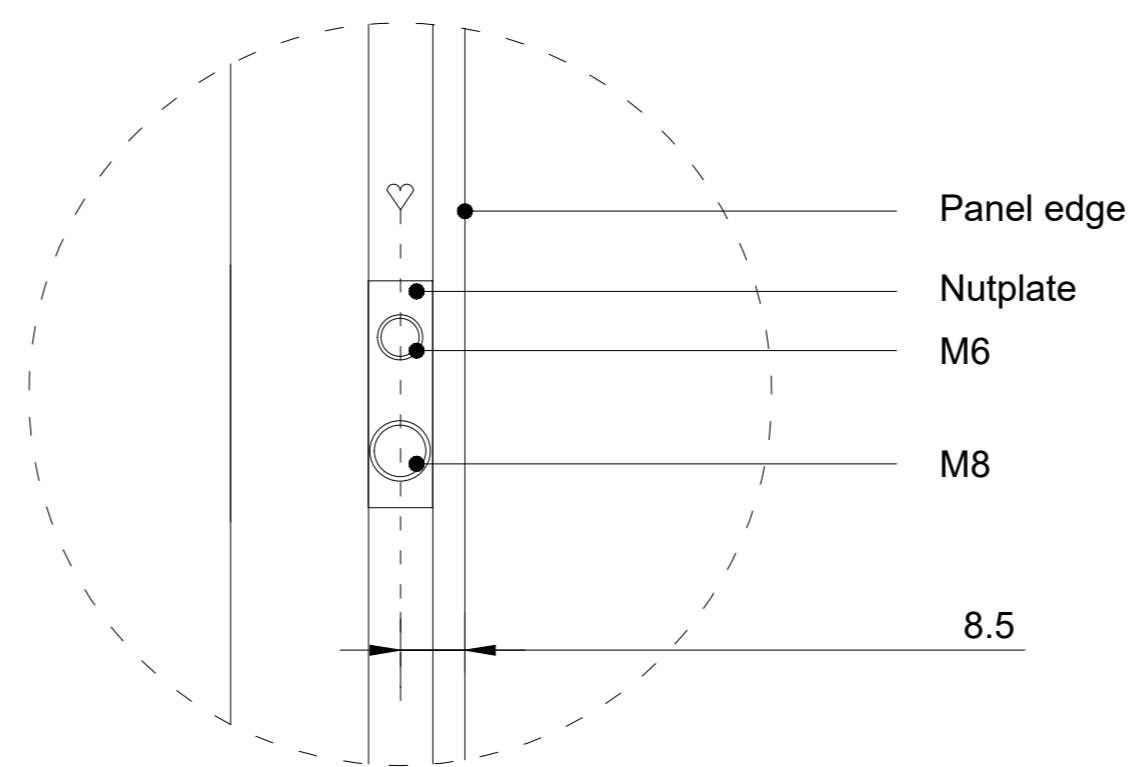

Backview (1:10)

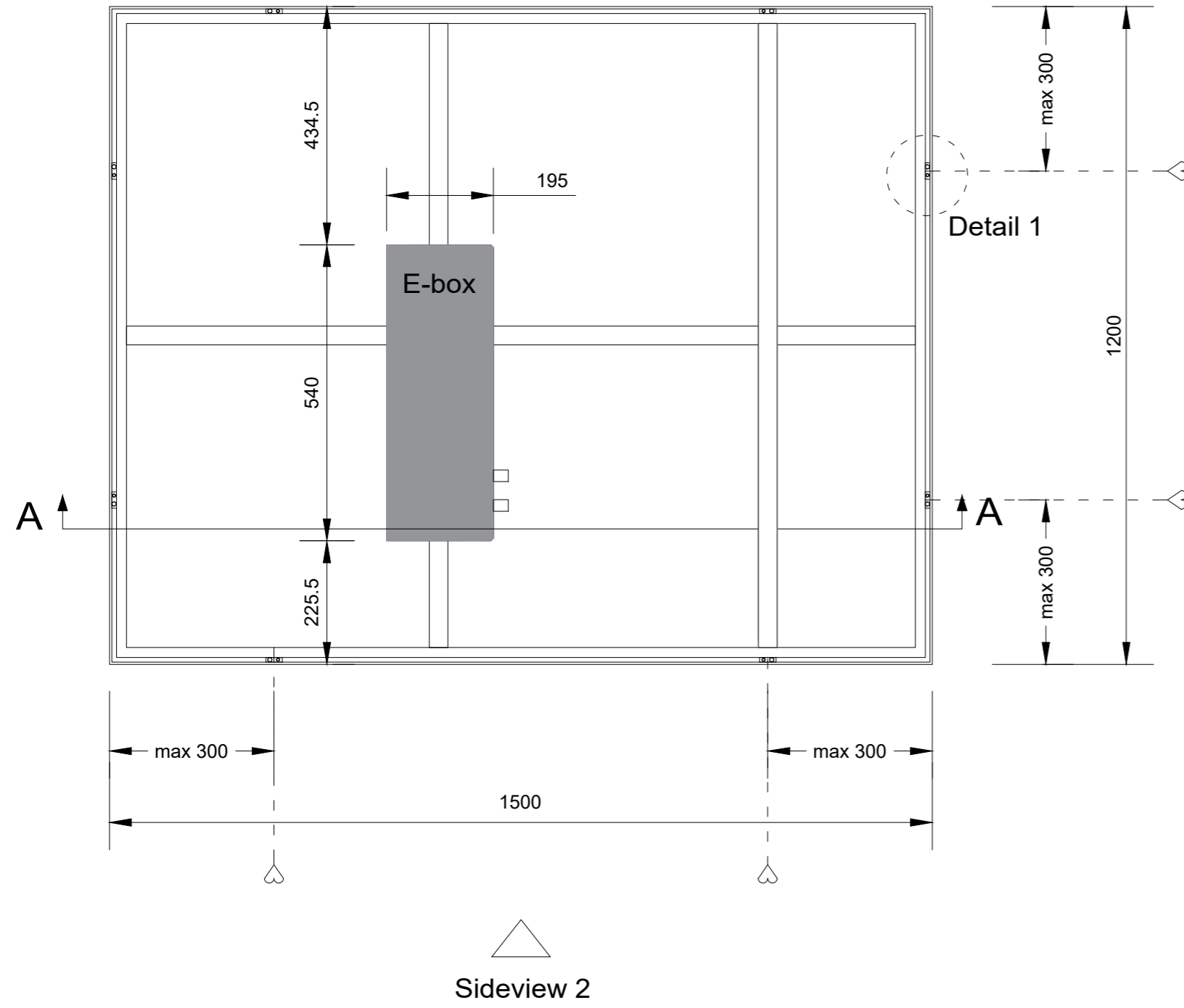

Sideview 1 - mounting position (1:10)

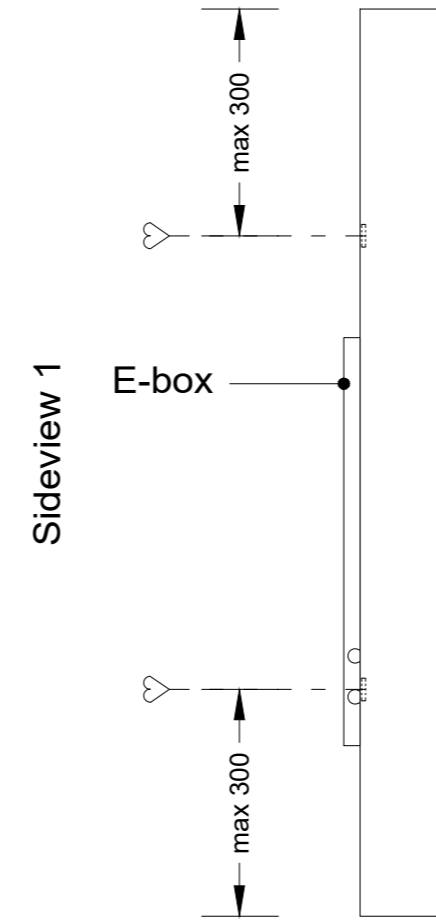

Sideview 2 - mounting position (1:10)

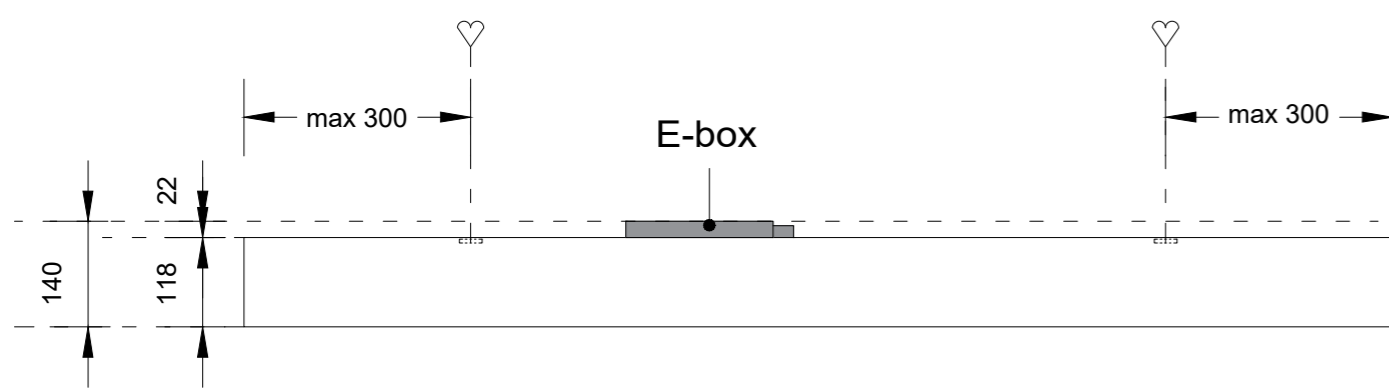

Section A-A (1:10)

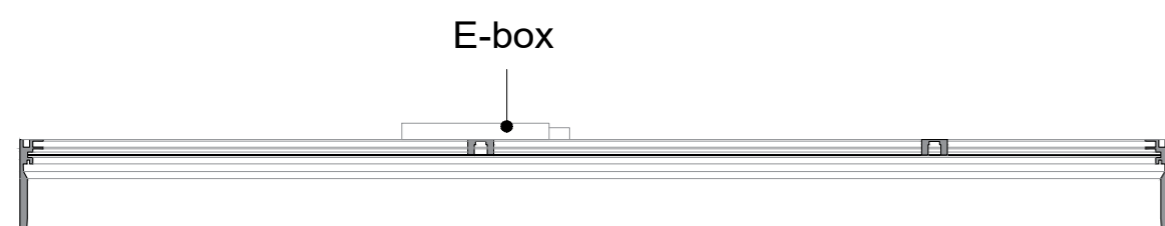

Detail 1 (1:1)

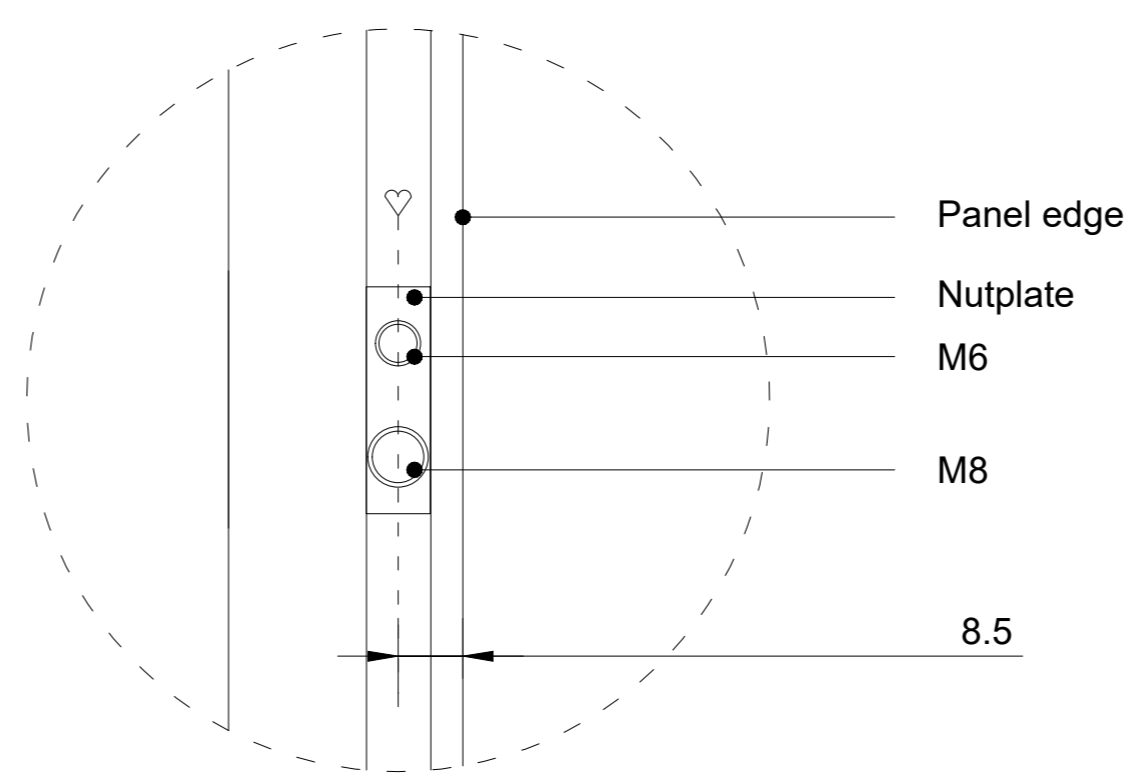

Backview (1:10)

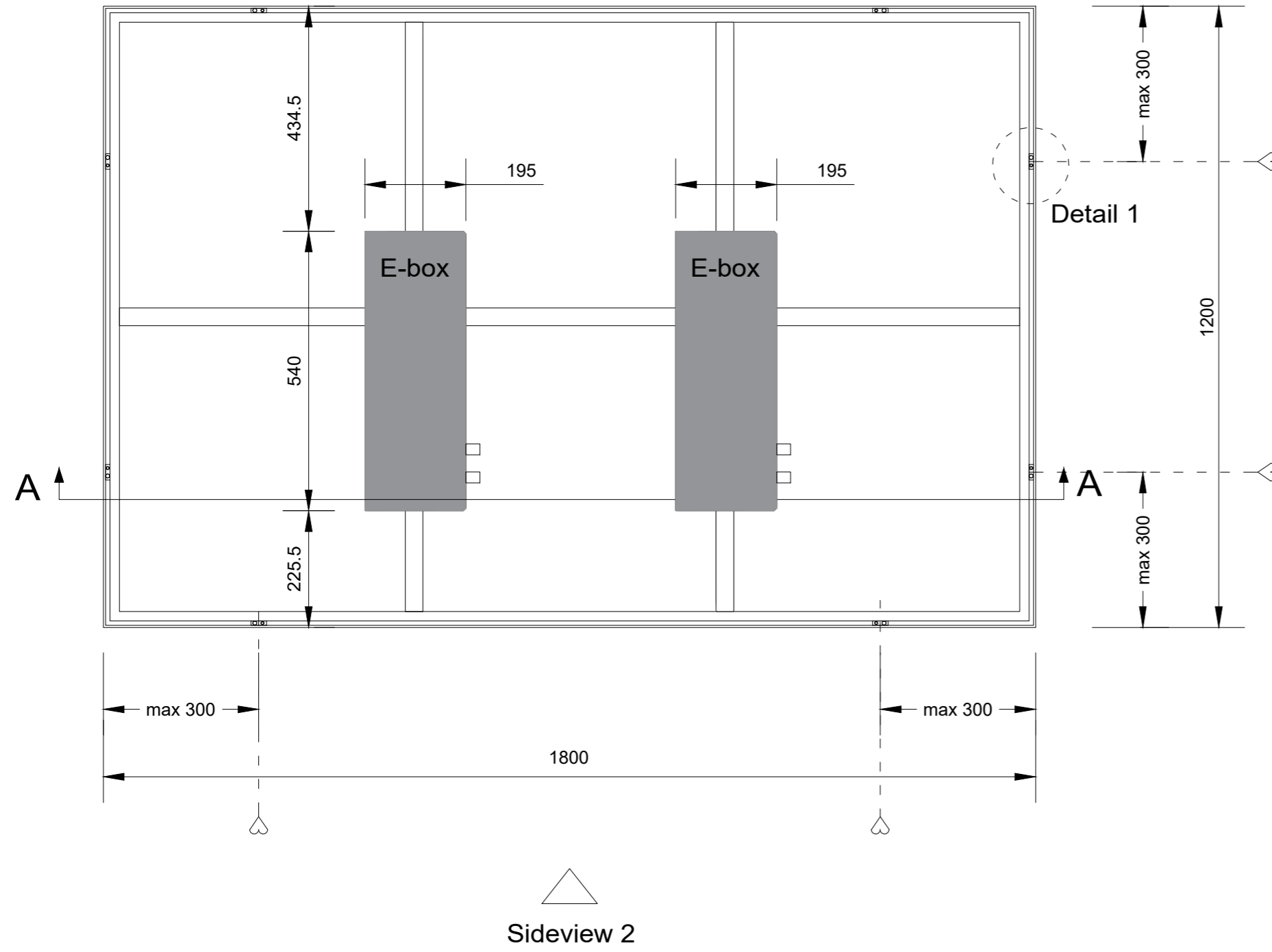

Sideview 1 - mounting position (1:10)

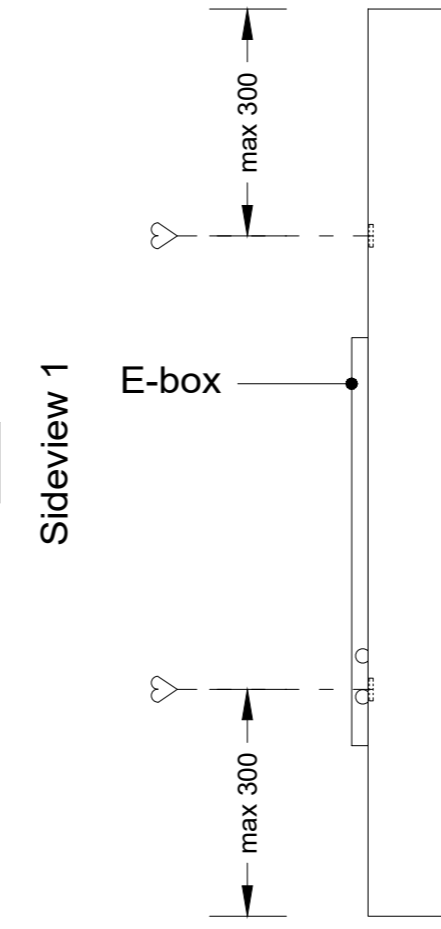

Sideview 2 - mounting position (1:10)

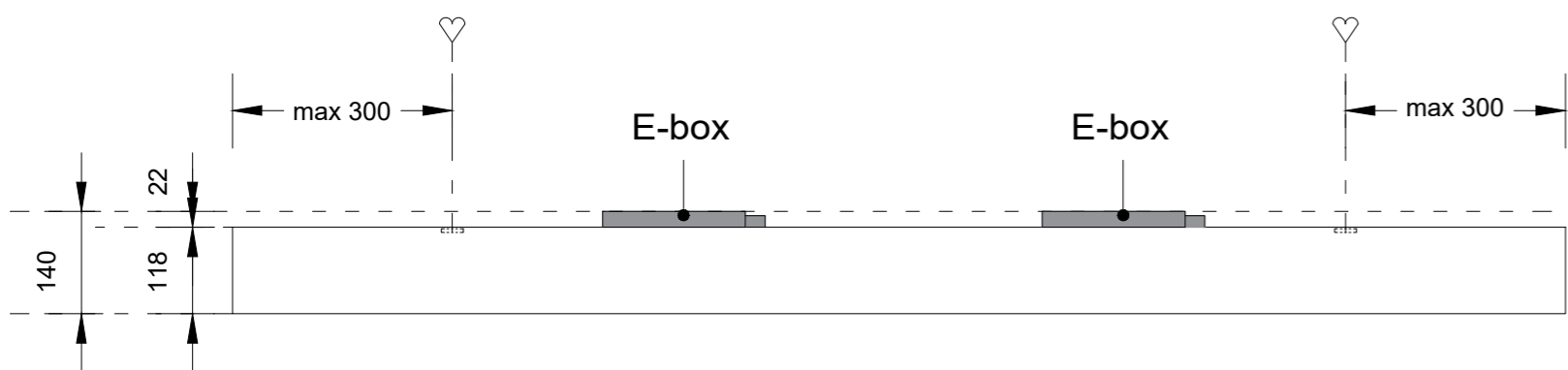

Section A-A (1:10)

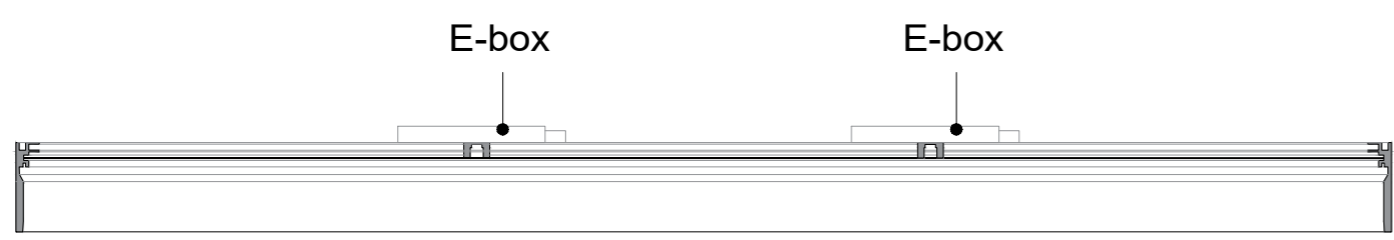

Detail 1 (1:1)

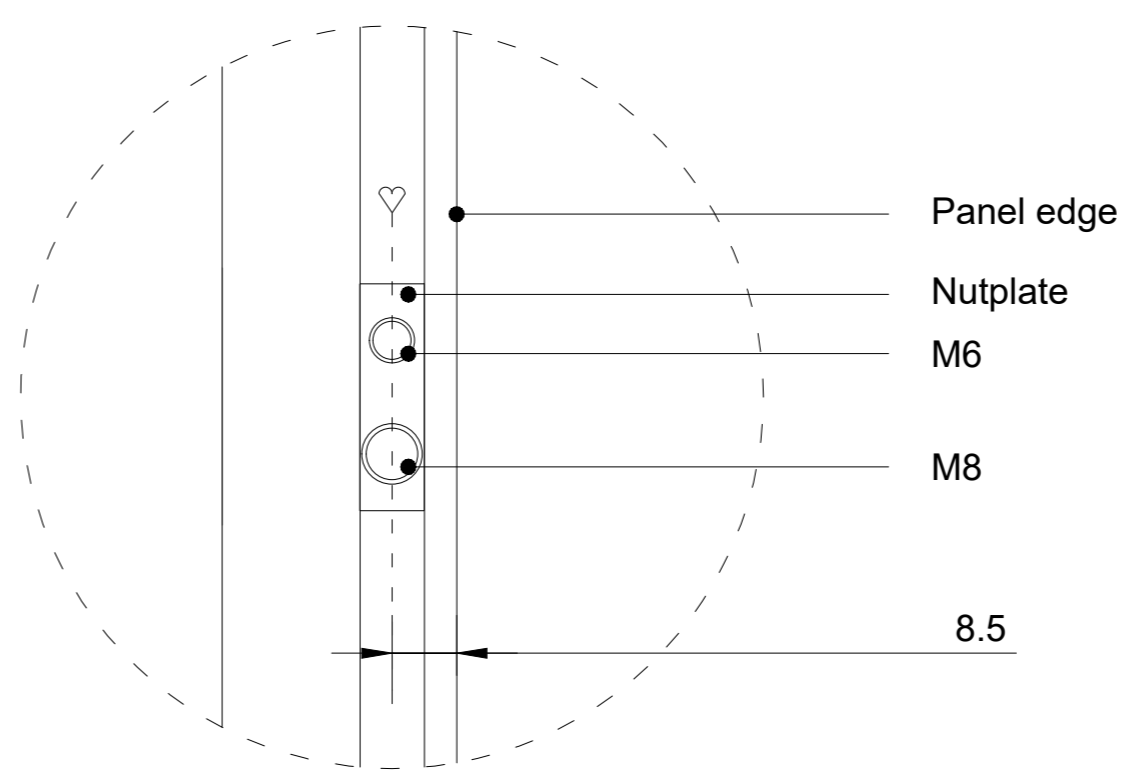

Backview (1:10)

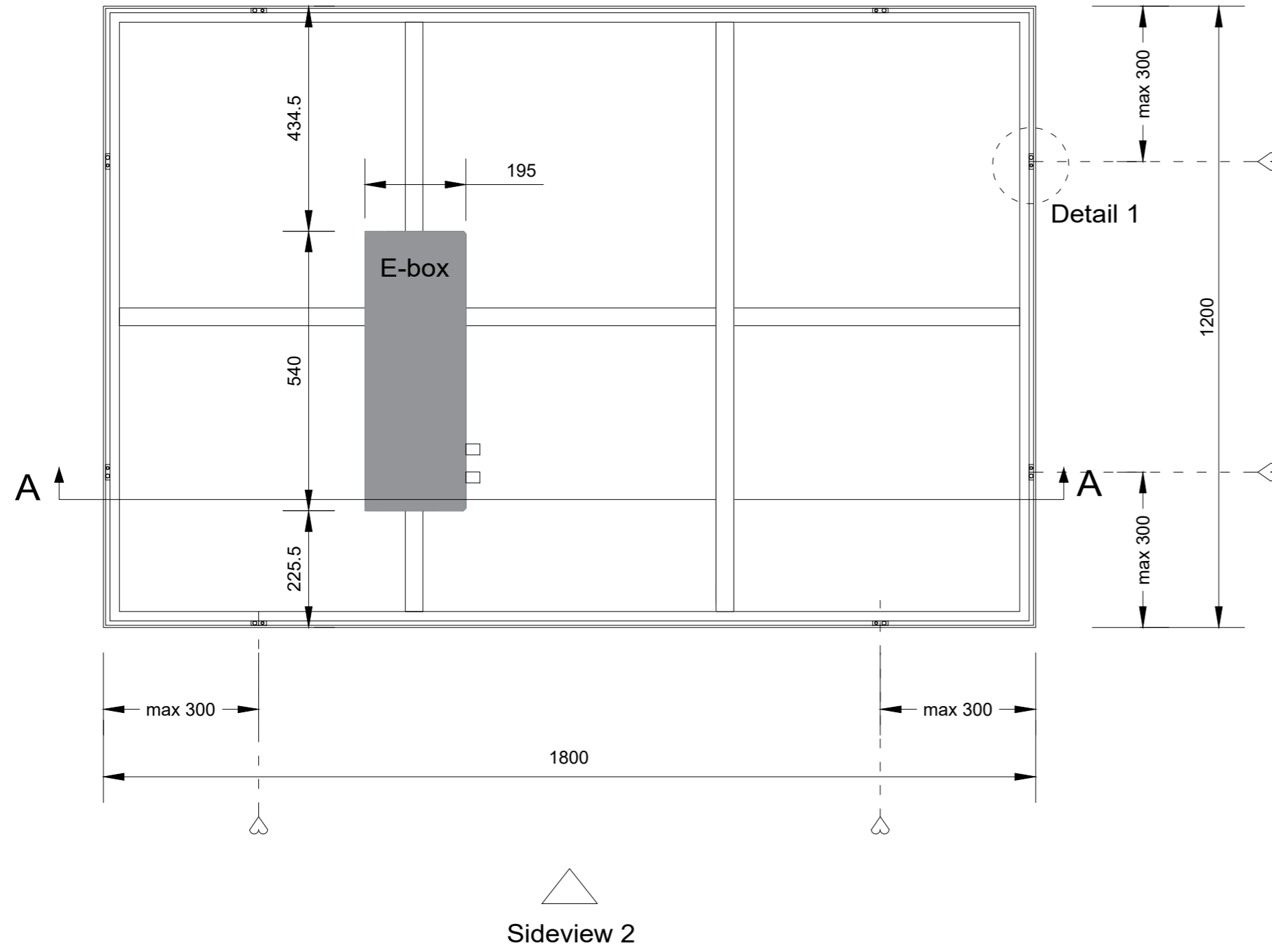

Sideview 1 - mounting position (1:10)

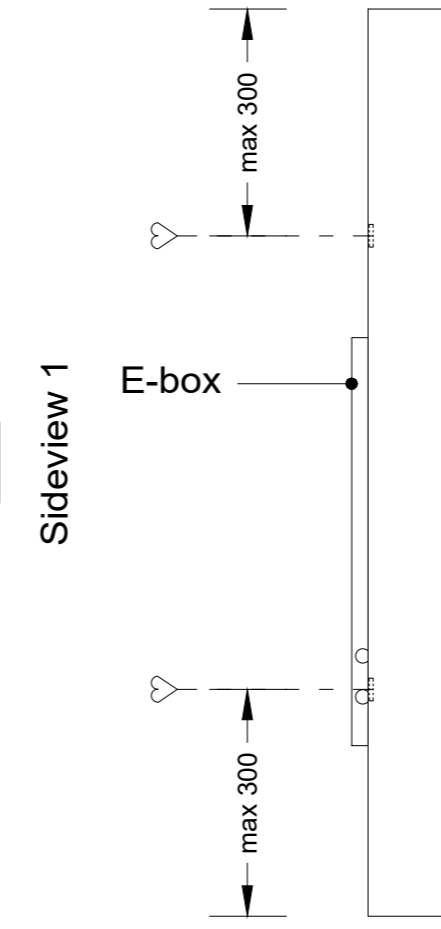

Sideview 2 - mounting position (1:10)

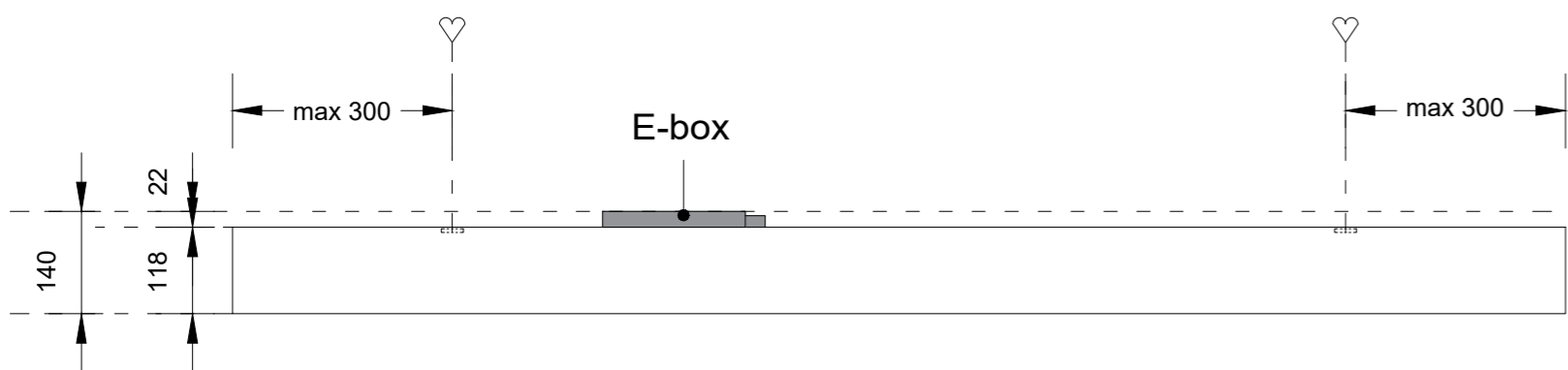

Section A-A (1:10)

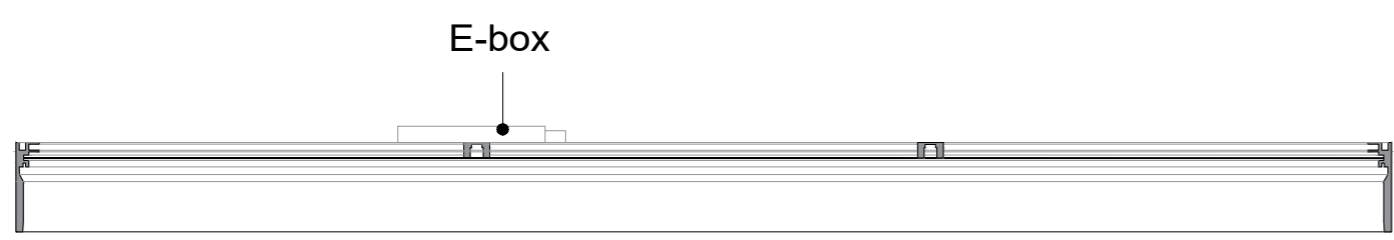

Detail 1 (1:1)

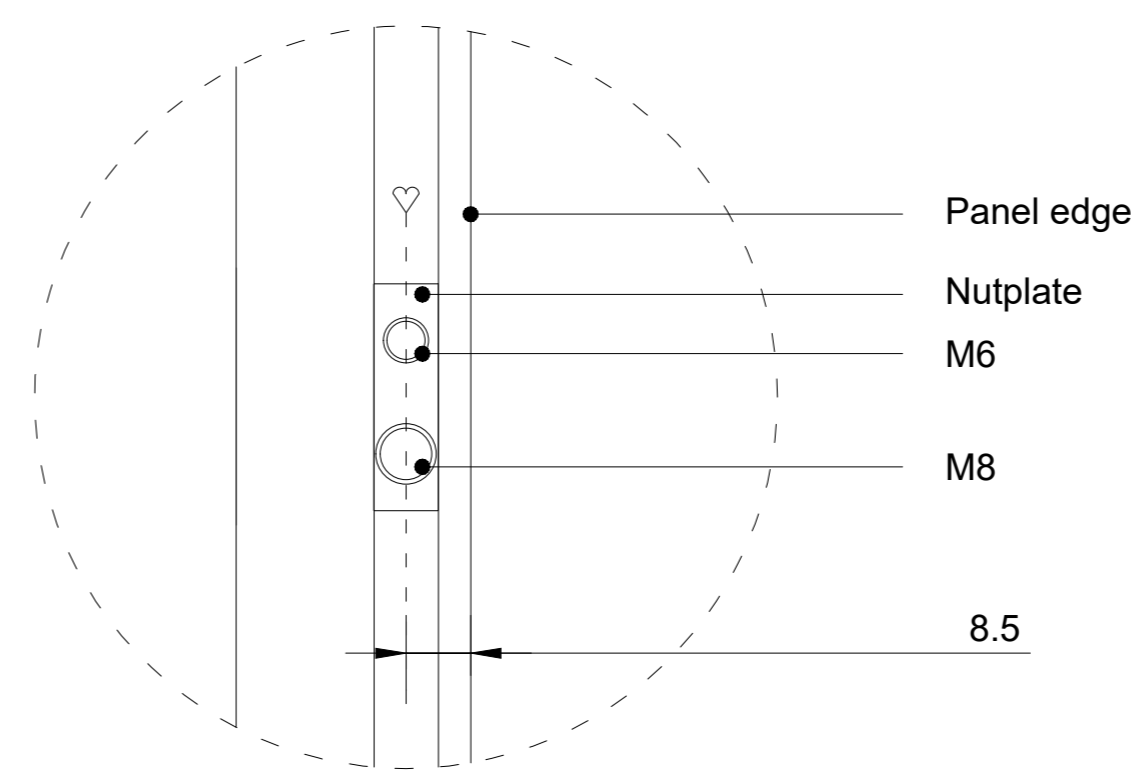



Backview (1:10)

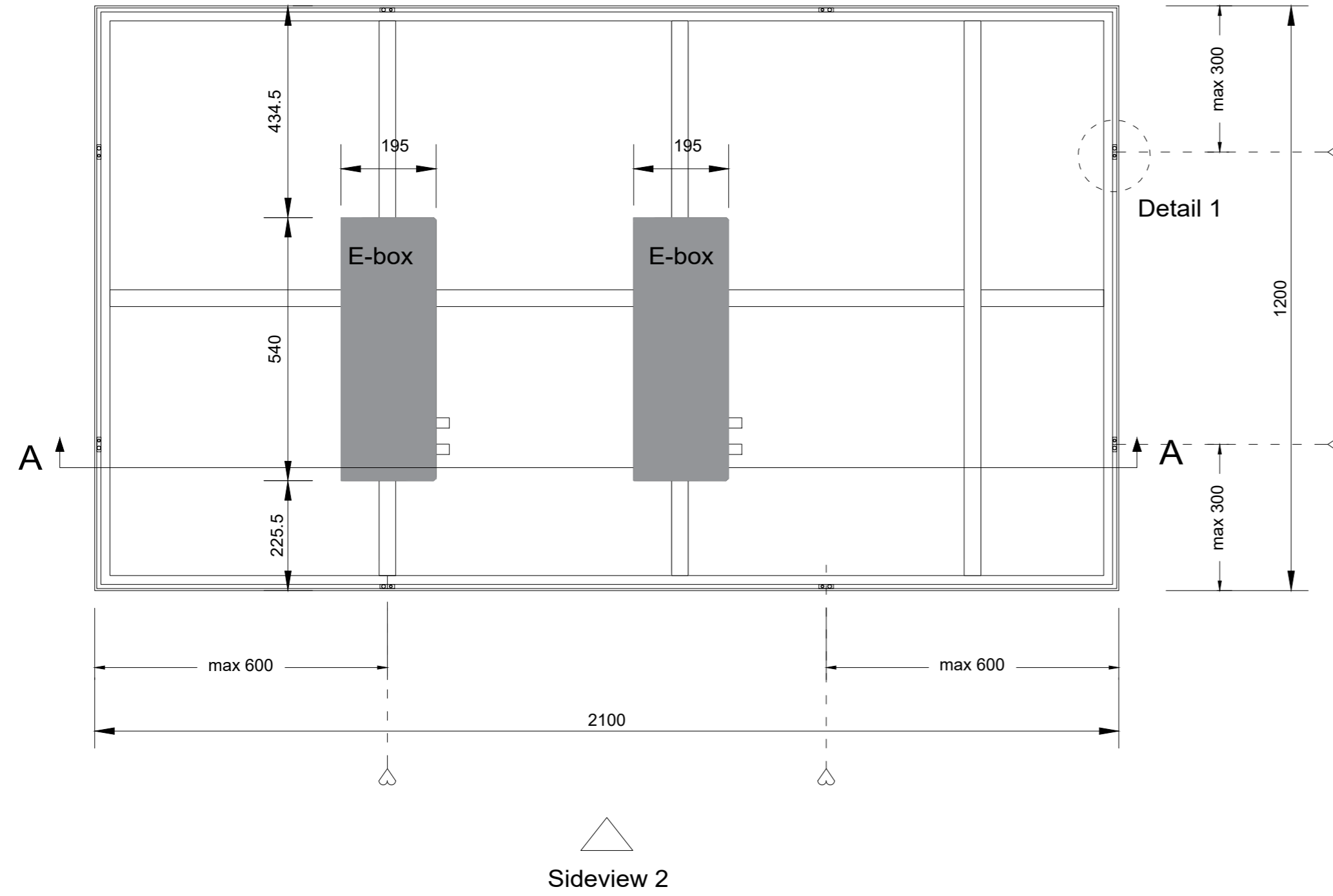

Sideview 1 - mounting position (1:10)

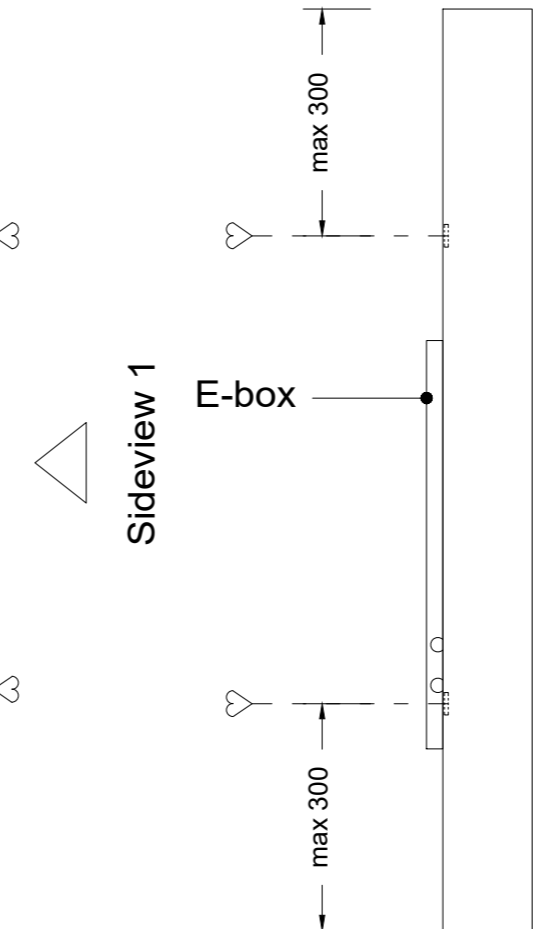

Sideview 2 - mounting position (1:10)

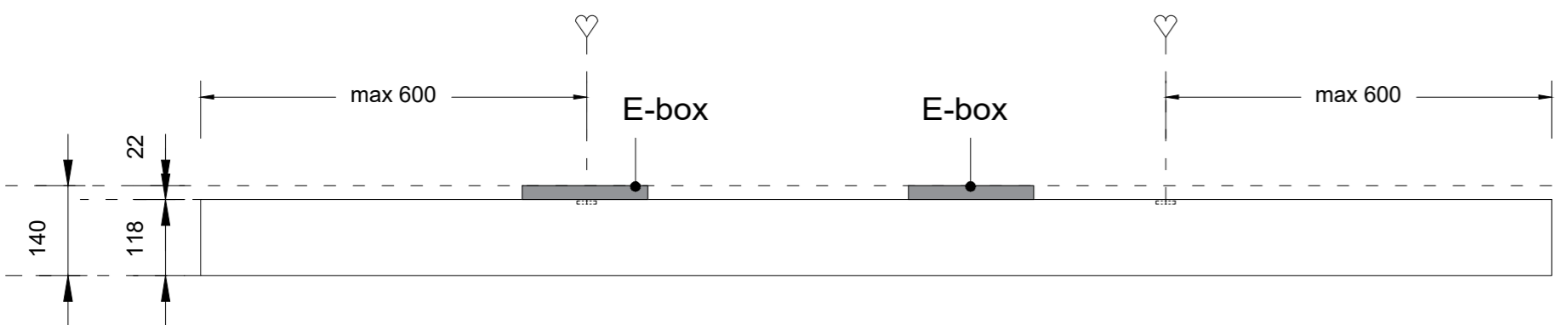

Section A-A (1:10)

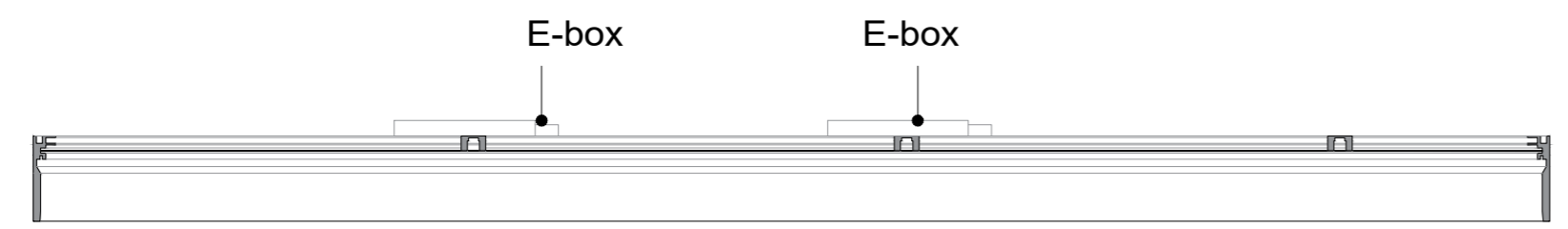

Detail 1 (1:1)

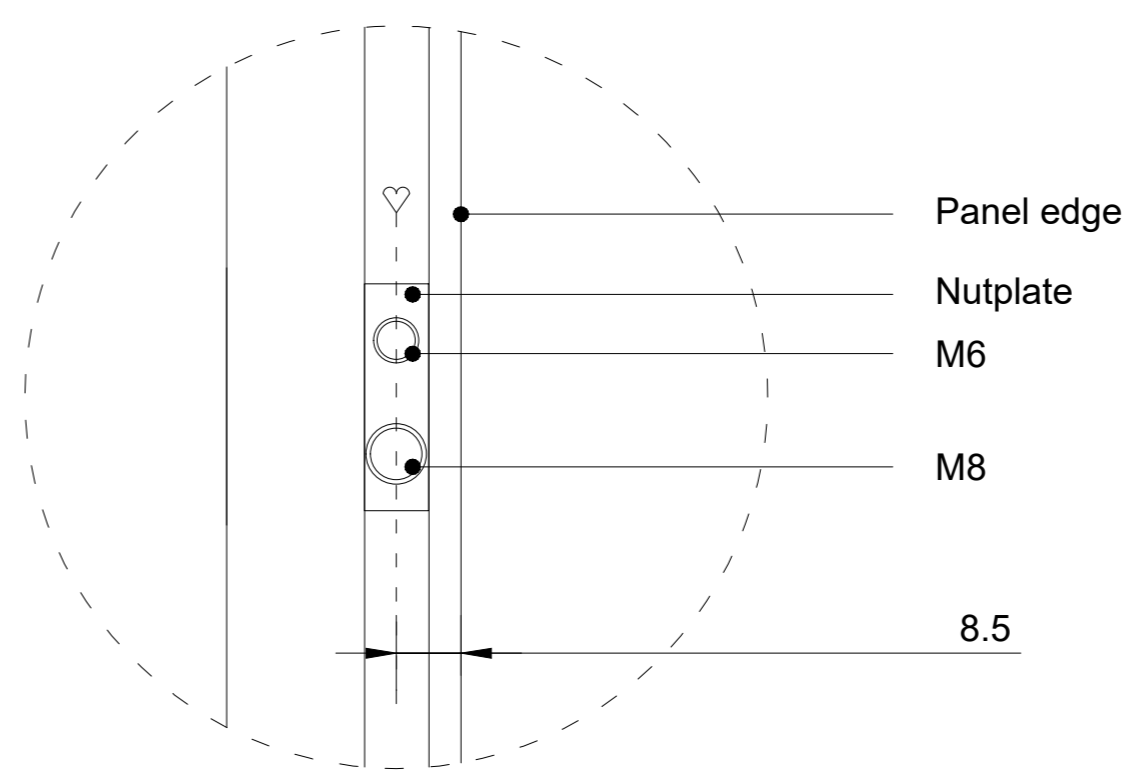

Backview (1:10)

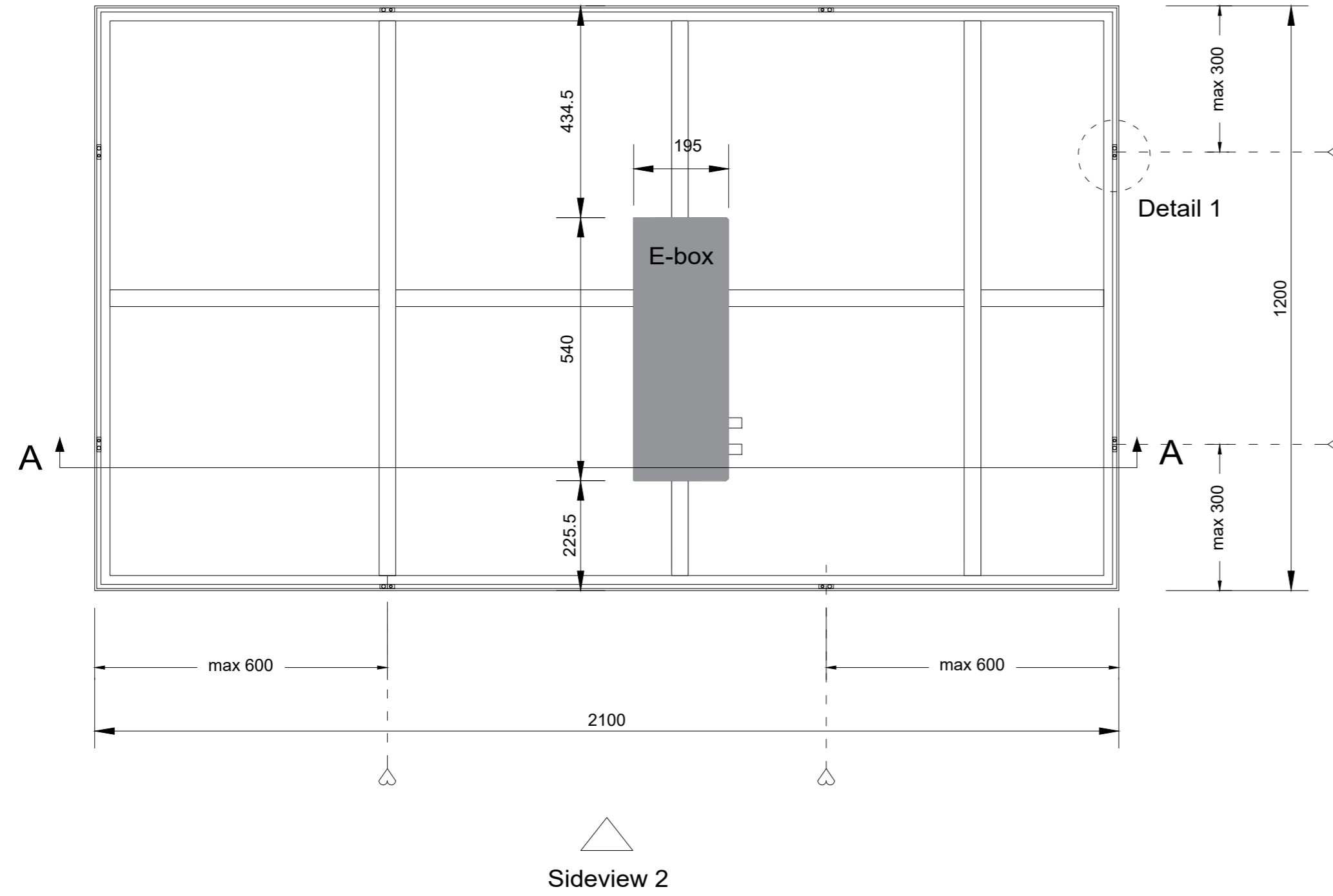

Sideview 1 - mounting position (1:10)

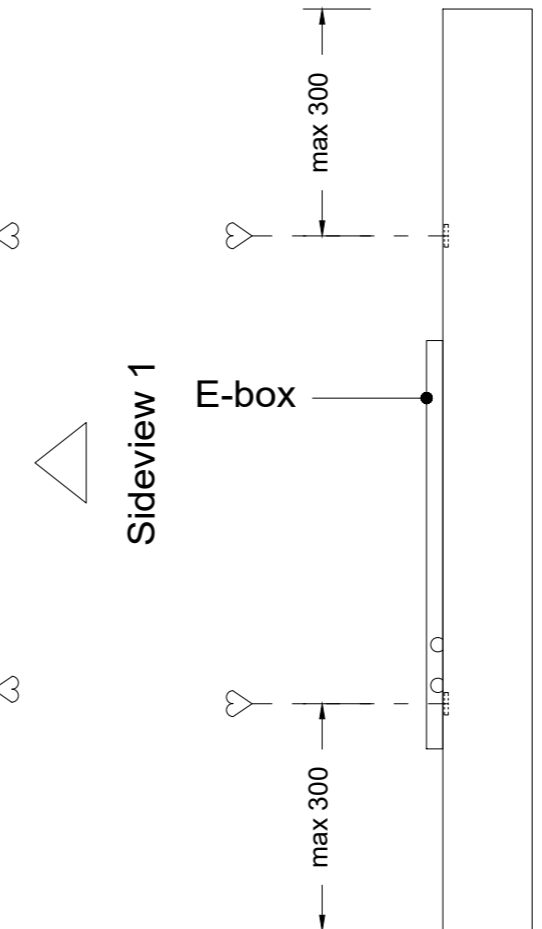

Sideview 2 - mounting position (1:10)

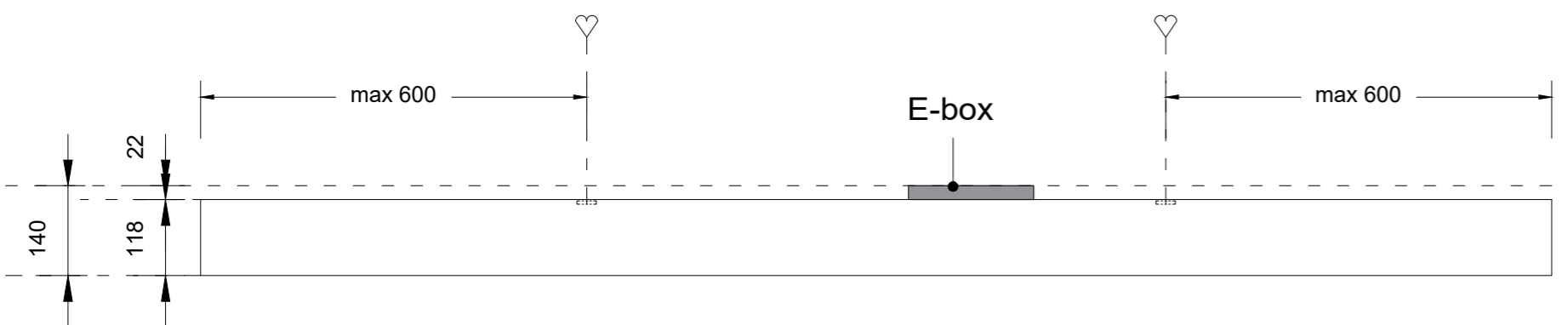

Section A-A (1:10)

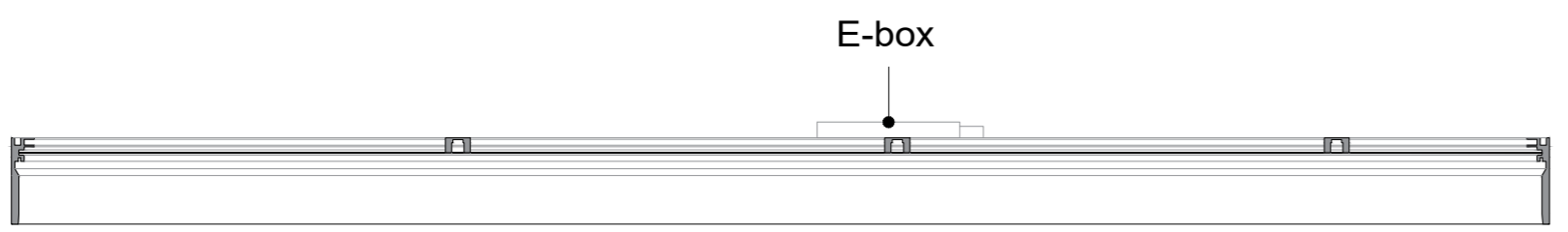

Detail 1 (1:1)

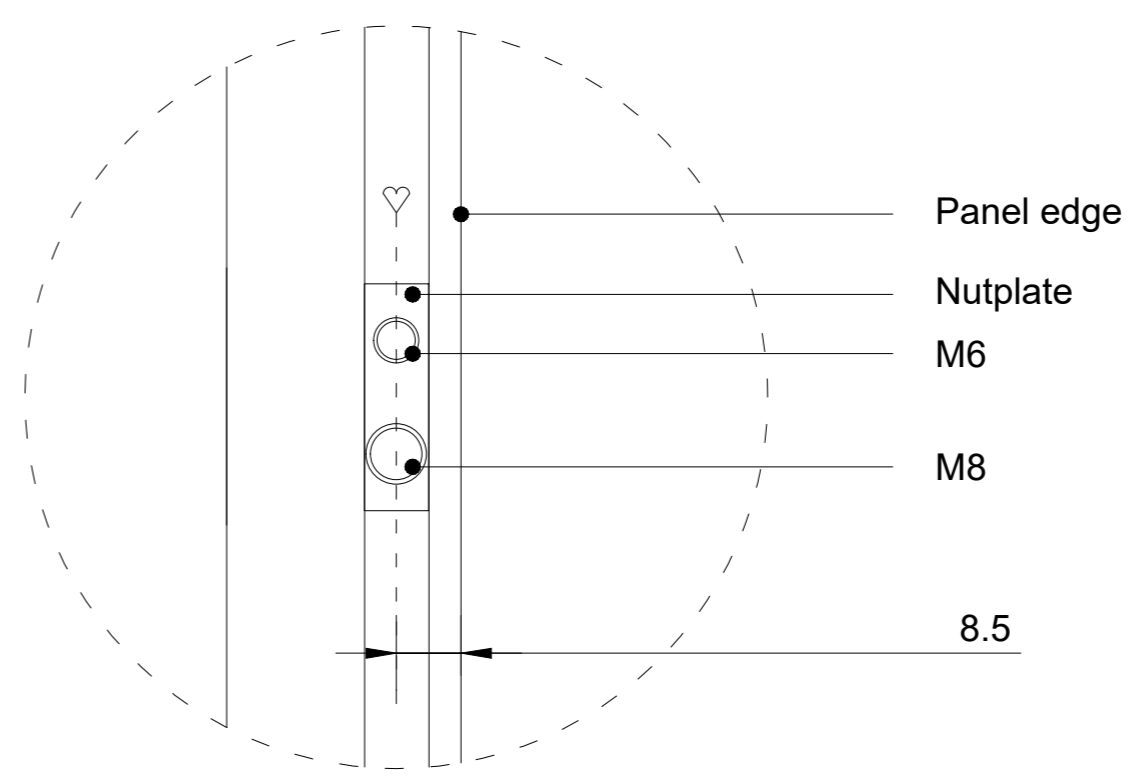

Backview (1:10)

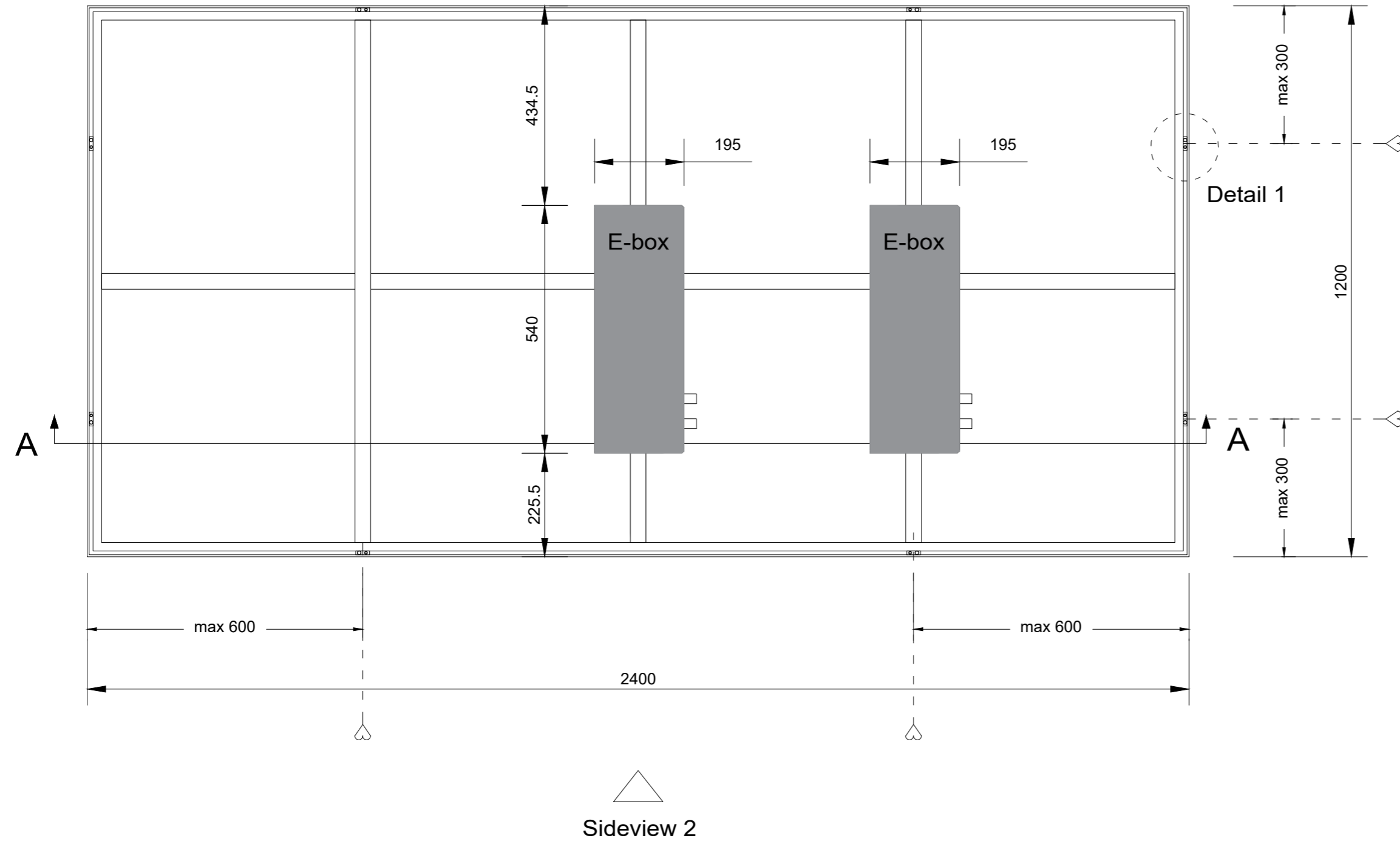

Sideview 1 - mounting position (1:10)

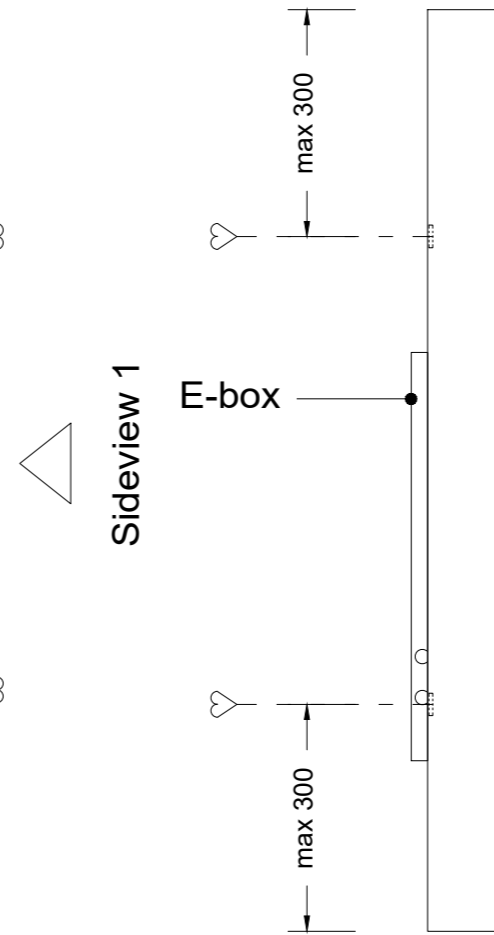

Sideview 2 - mounting position (1:10)

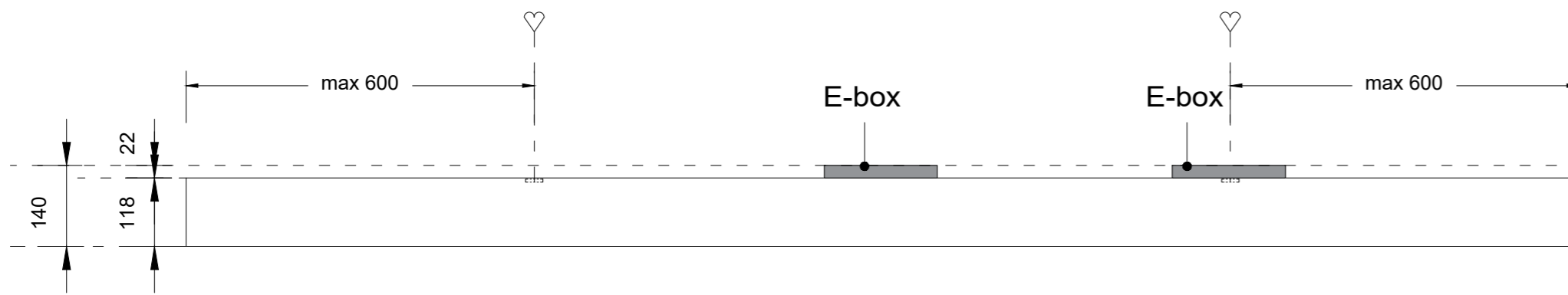

Section A-A (1:10)

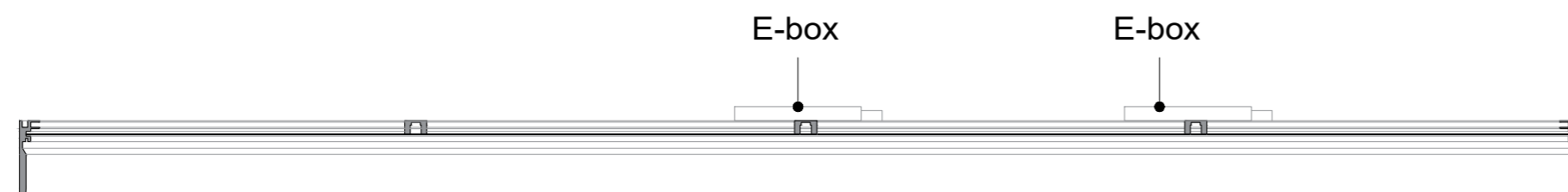

Detail 1 (1:1)

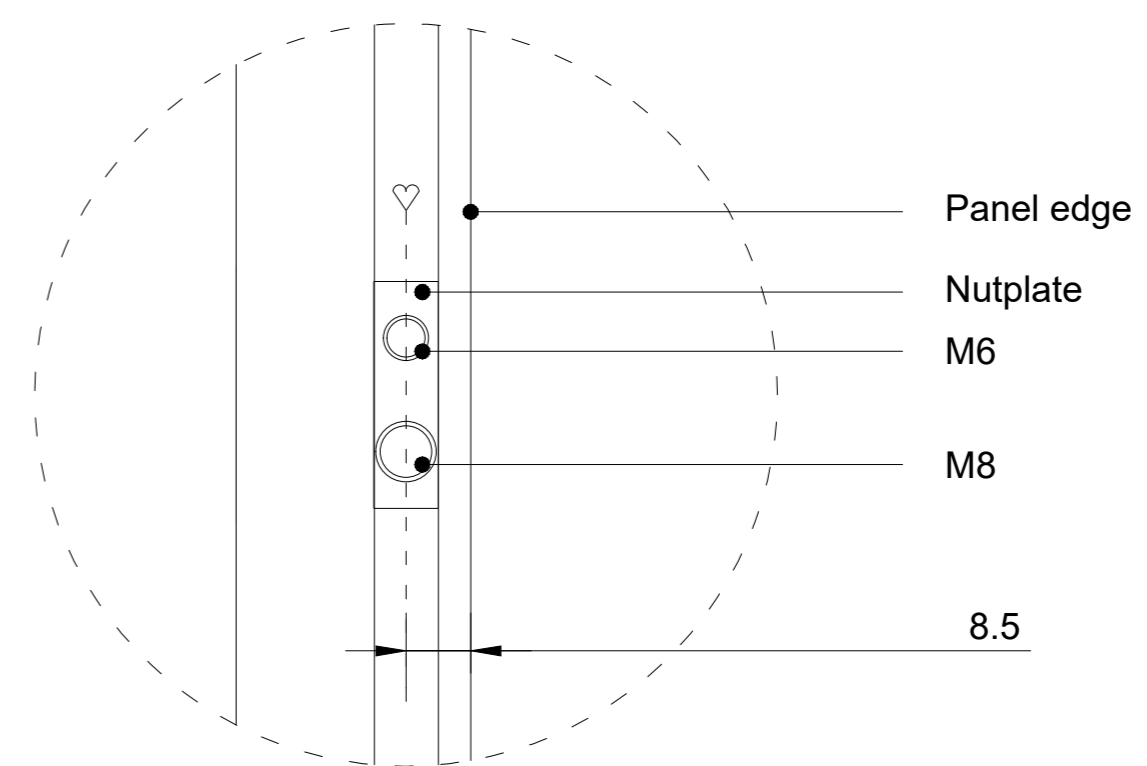

Backview (1:10)

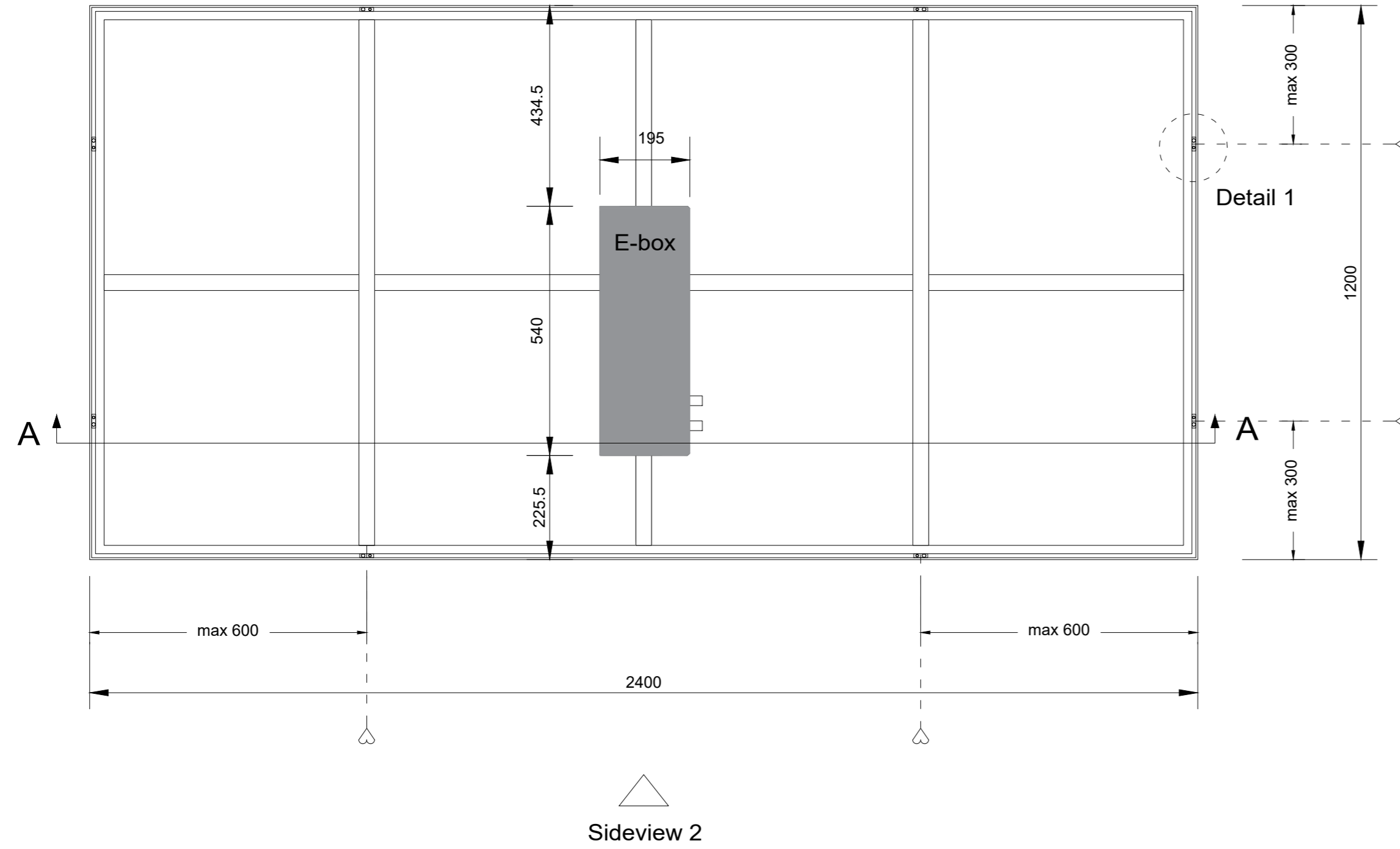

Sideview 1 - mounting position (1:10)

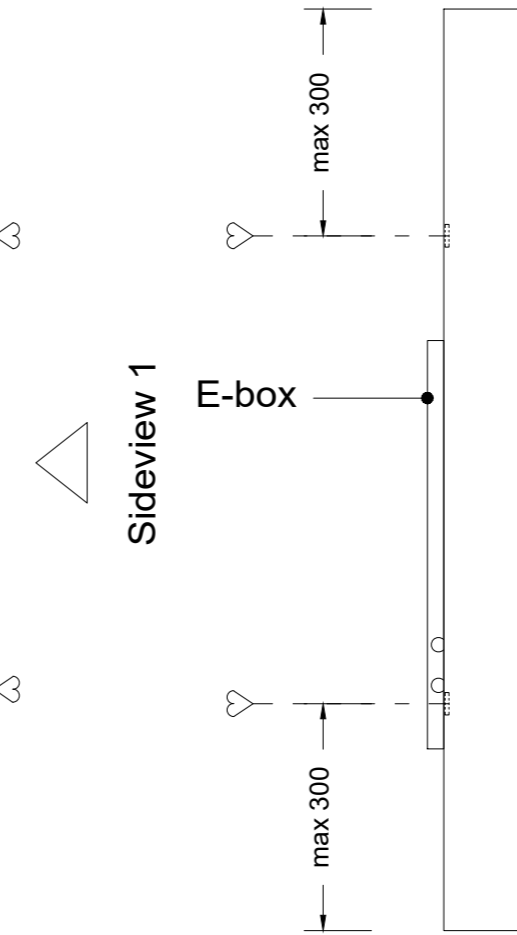

Sideview 2 - mounting position (1:10)

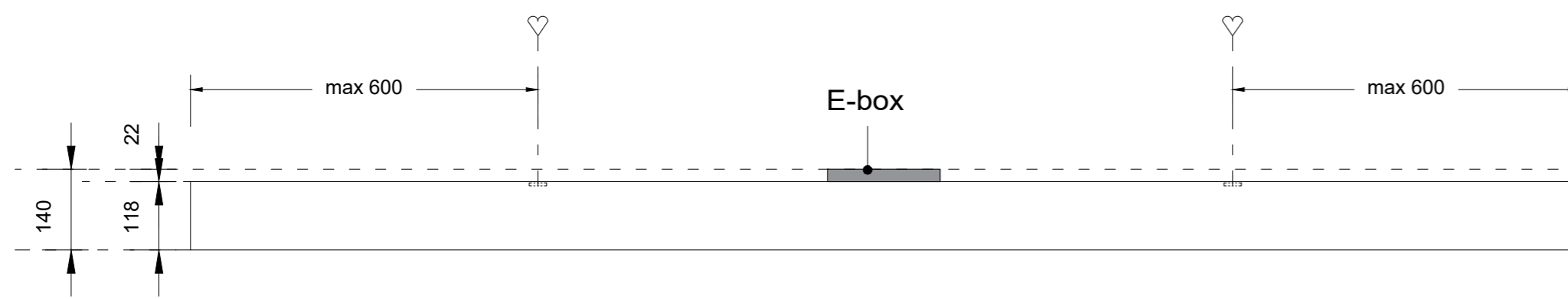

Section A-A (1:10)

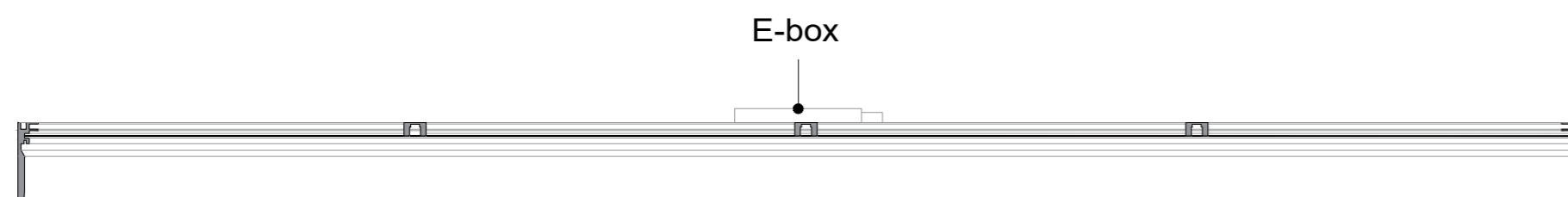

Detail 1 (1:1)

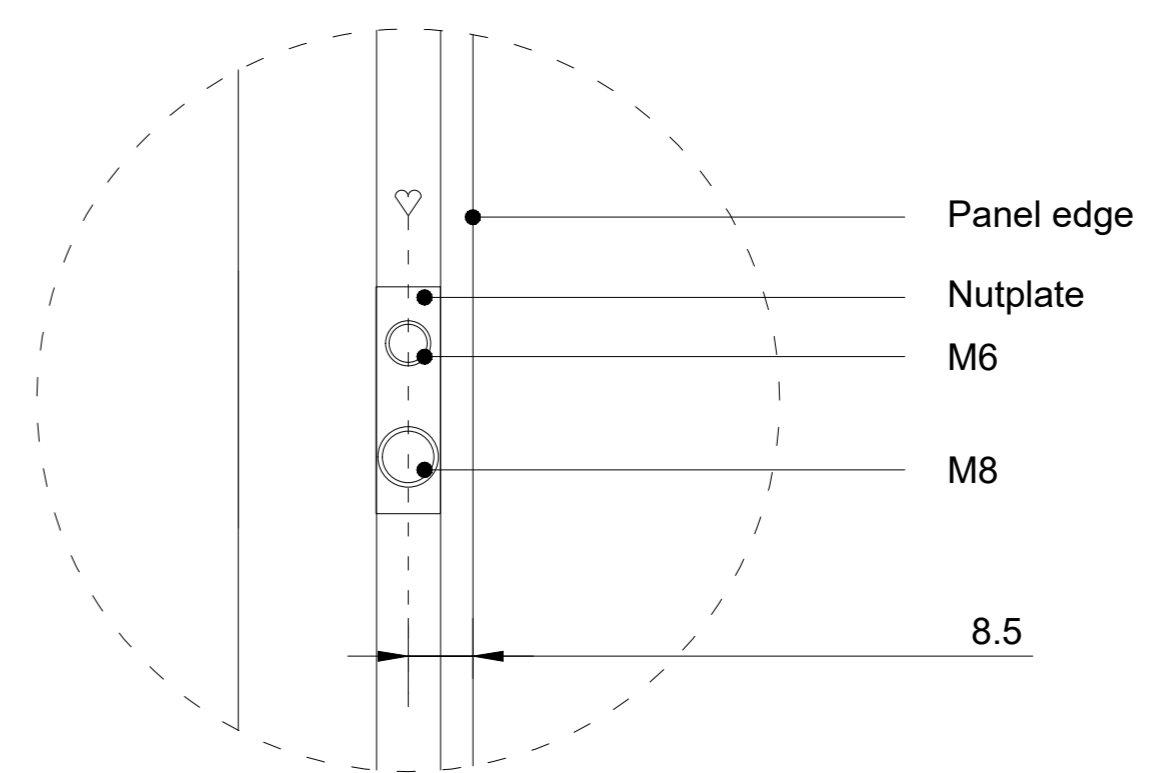

Backview (1:10)

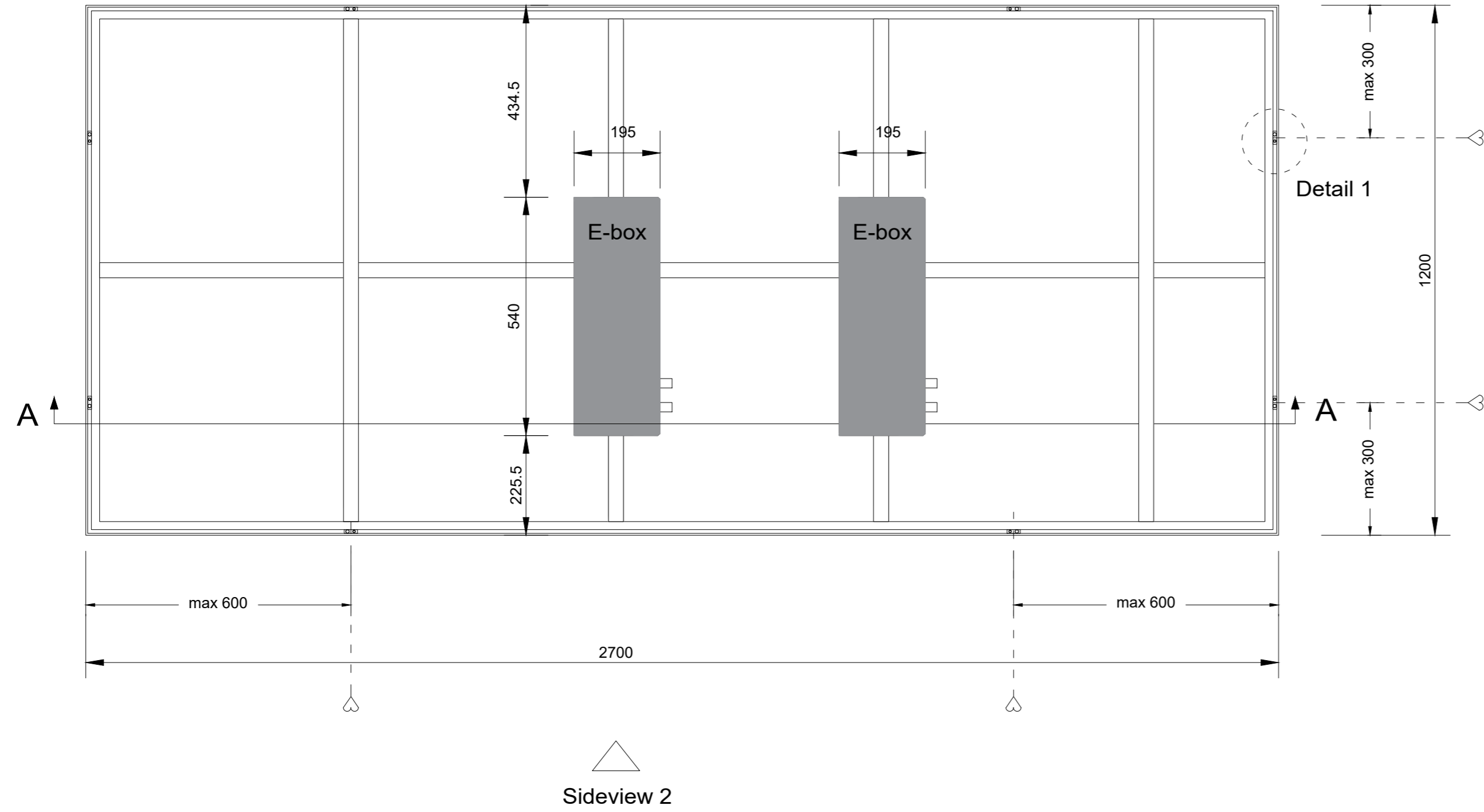

Sideview 1 - mounting position (1:10)

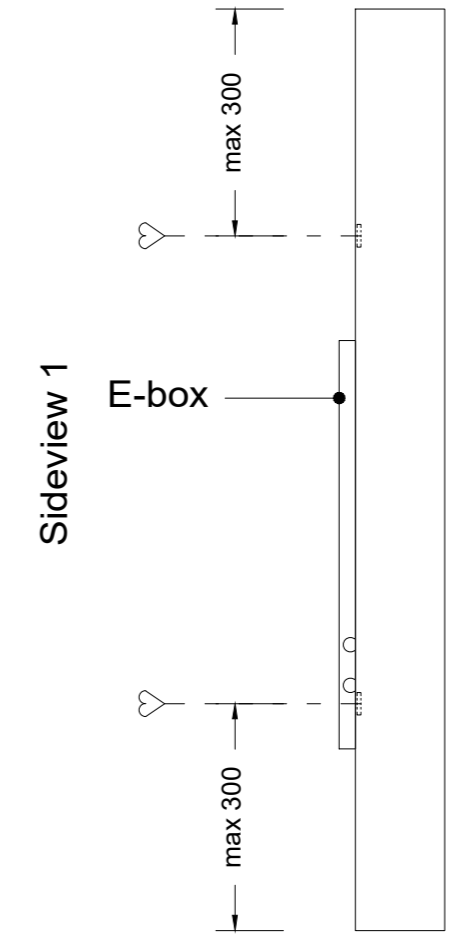

Sideview 2 - mounting position (1:10)

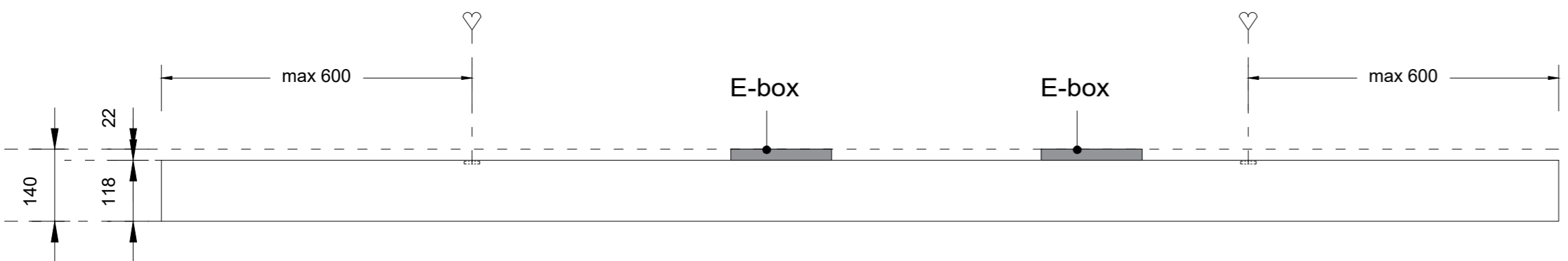

Section A-A (1:10)

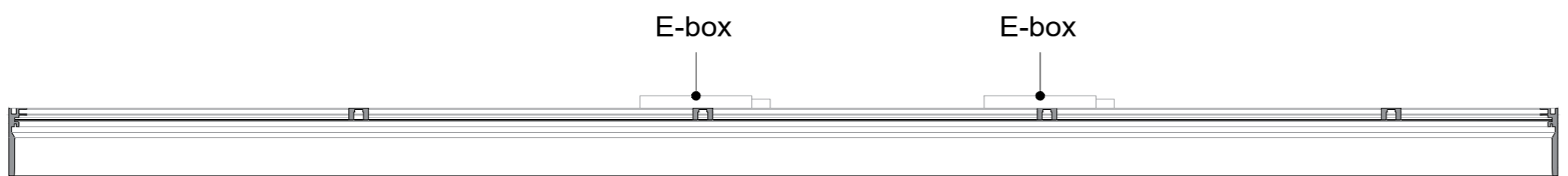

Detail 1 (1:1)

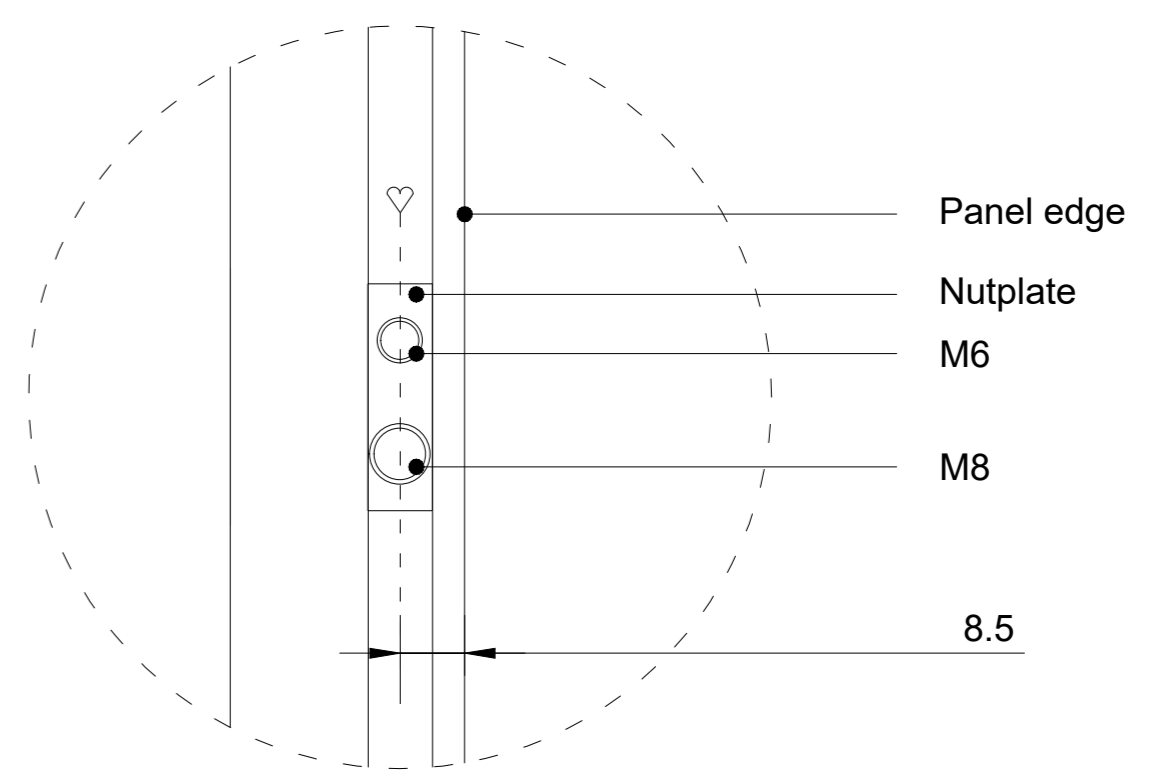

Backview (1:10)

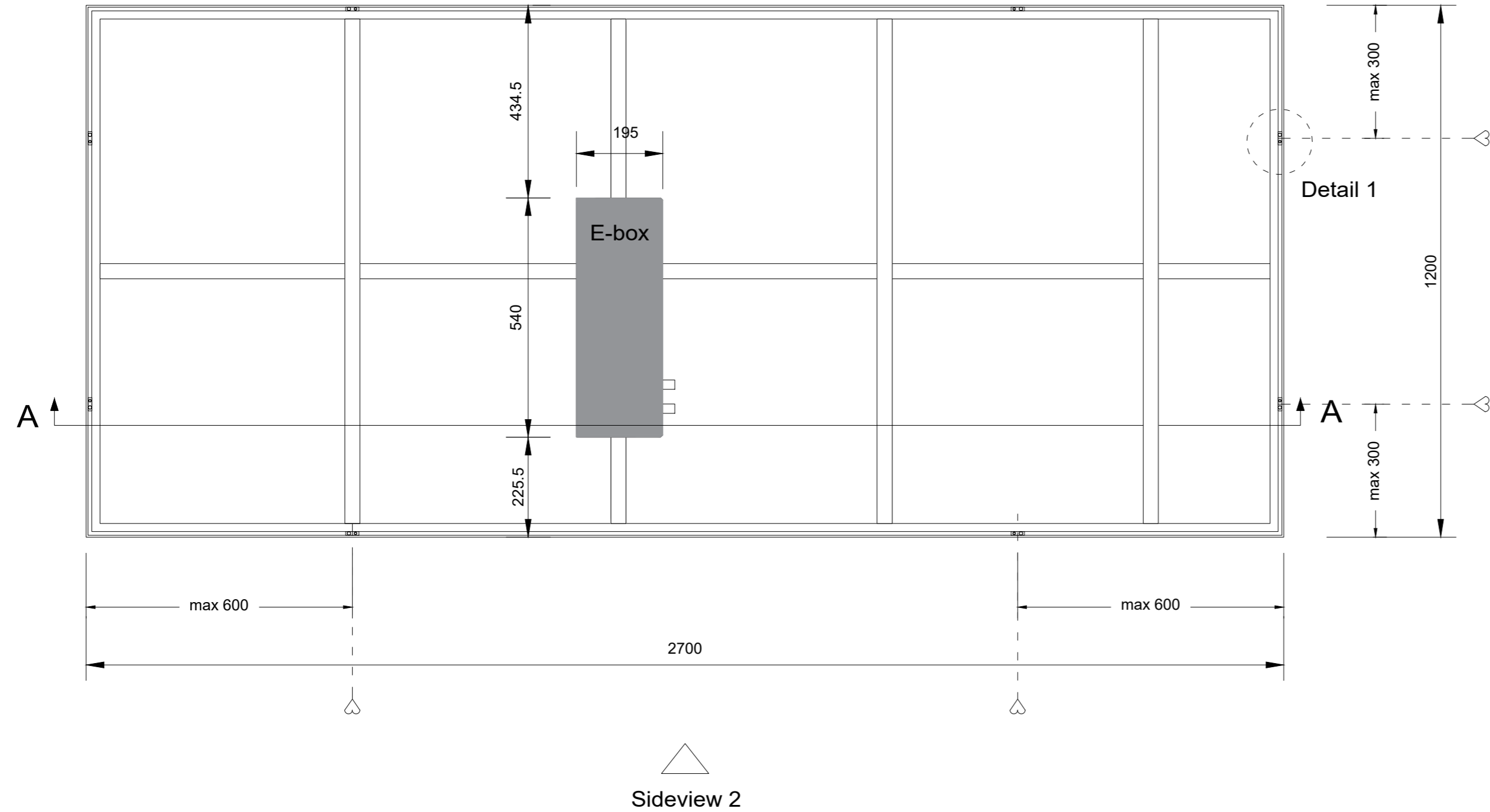

Sideview 1 - mounting position (1:10)

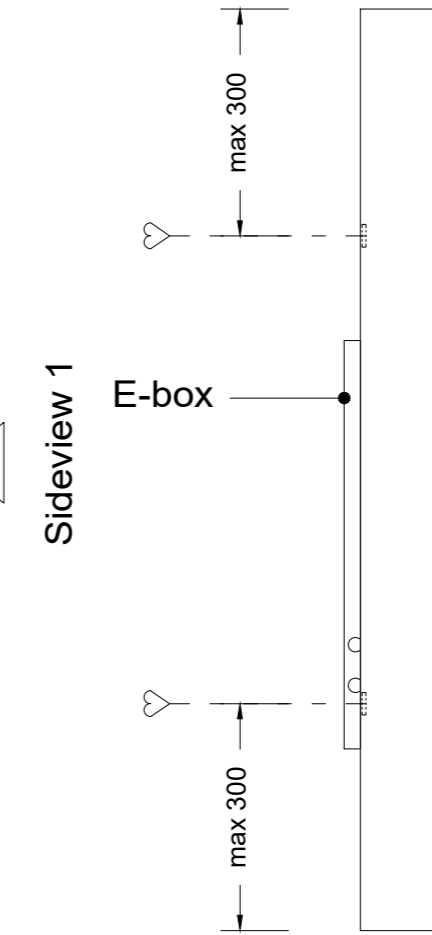

Sideview 2 - mounting position (1:10)

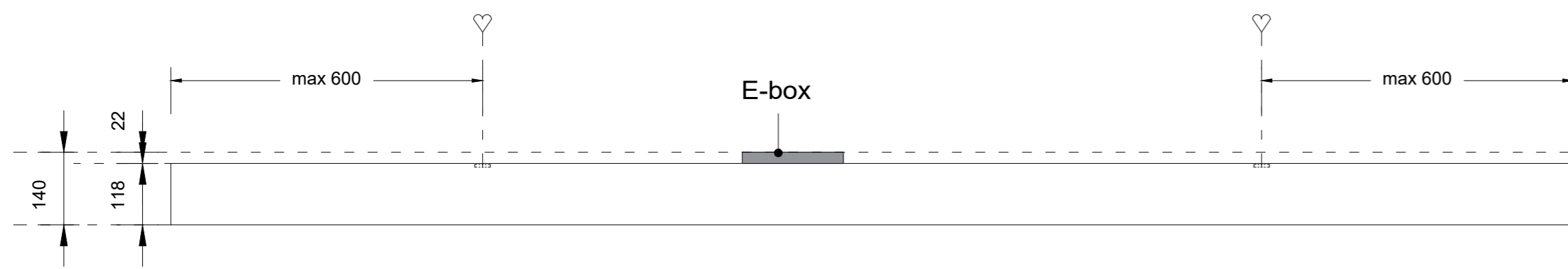

Section A-A (1:10)

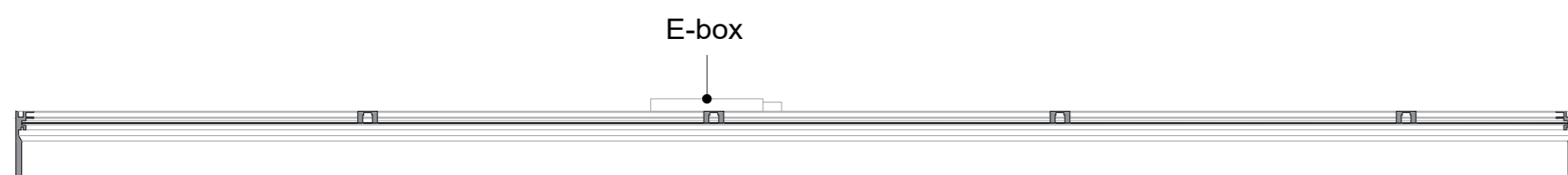

Detail 1 (1:1)

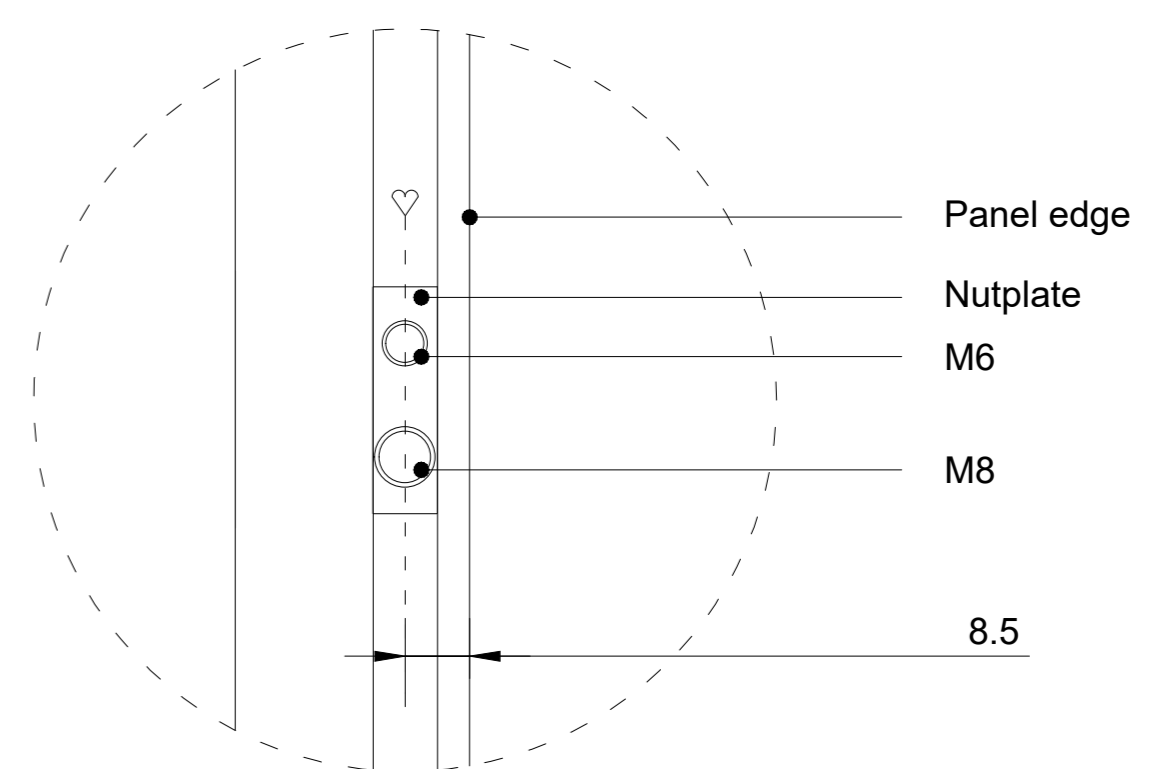

Backview (1:10)

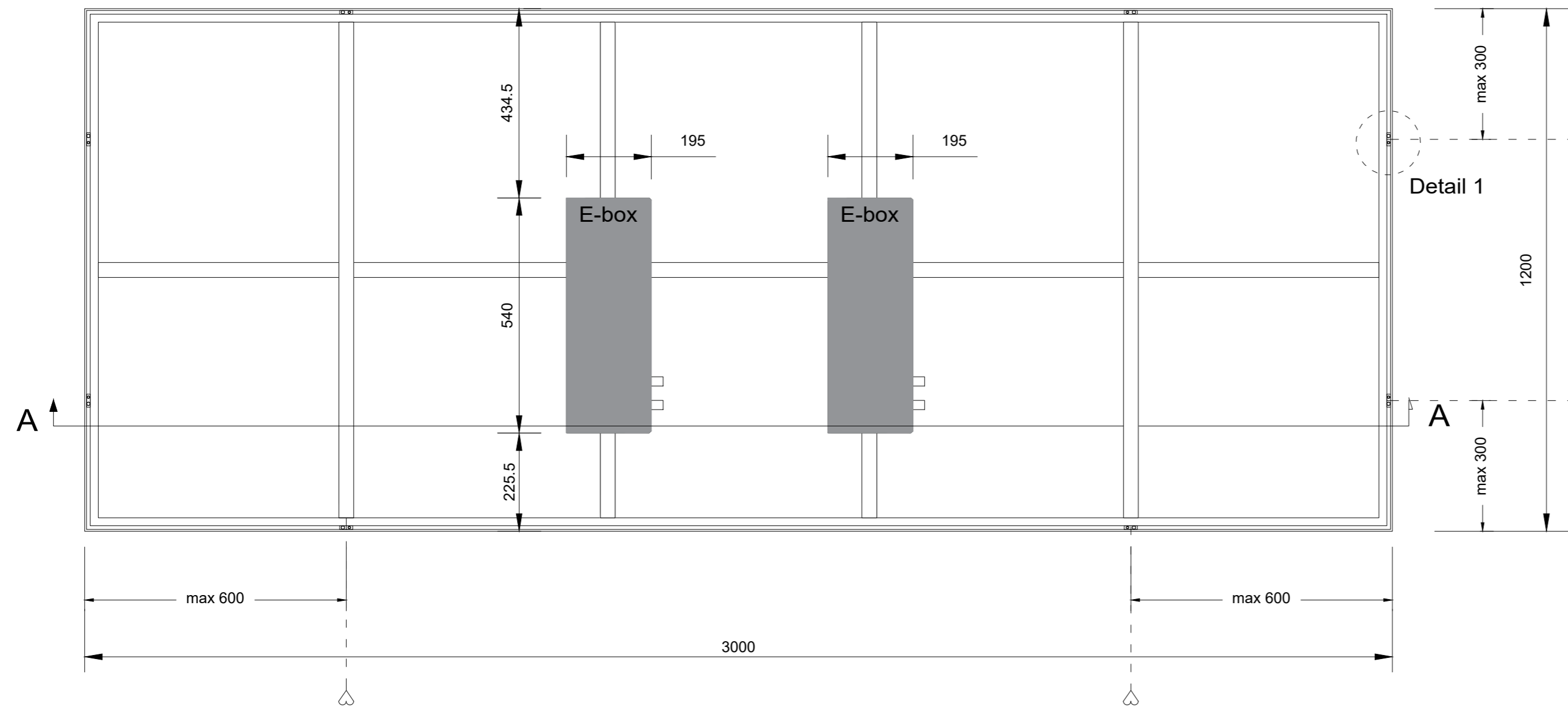

Sideview 2

Sideview 1 - mounting position (1:10)

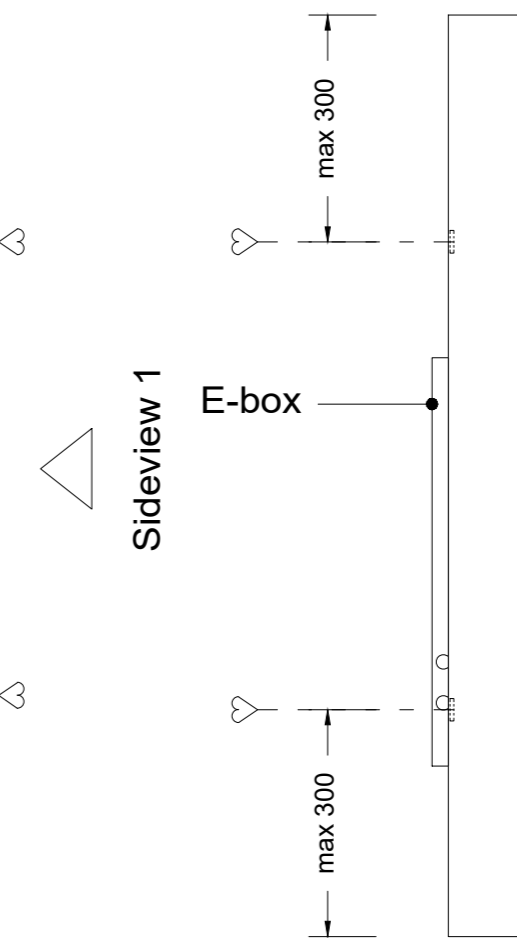

Sideview 2 - mounting position (1:10)

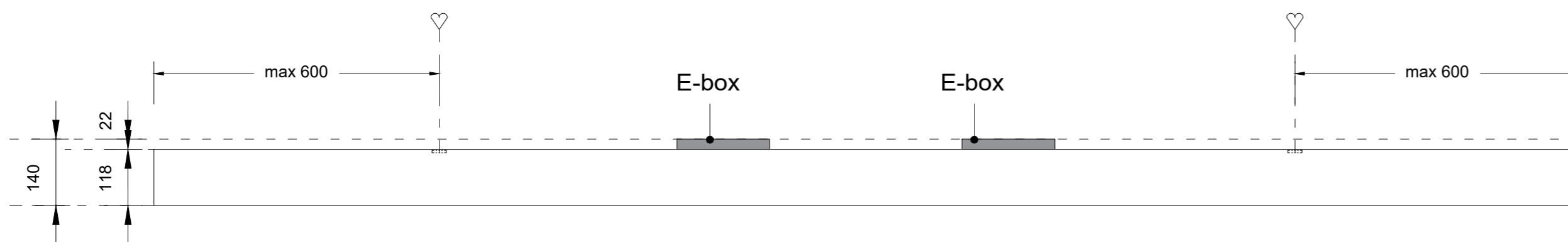

Section A-A (1:10)

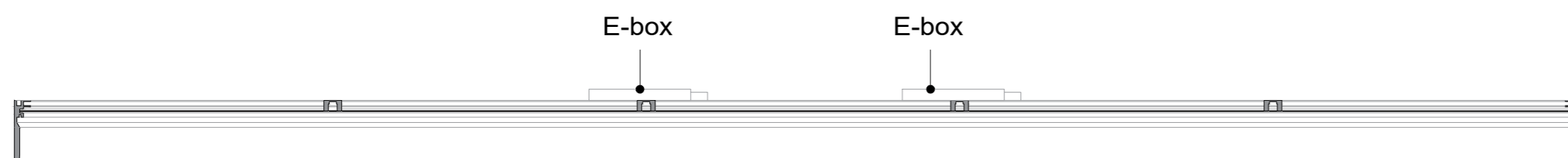

Detail 1 (1:1)

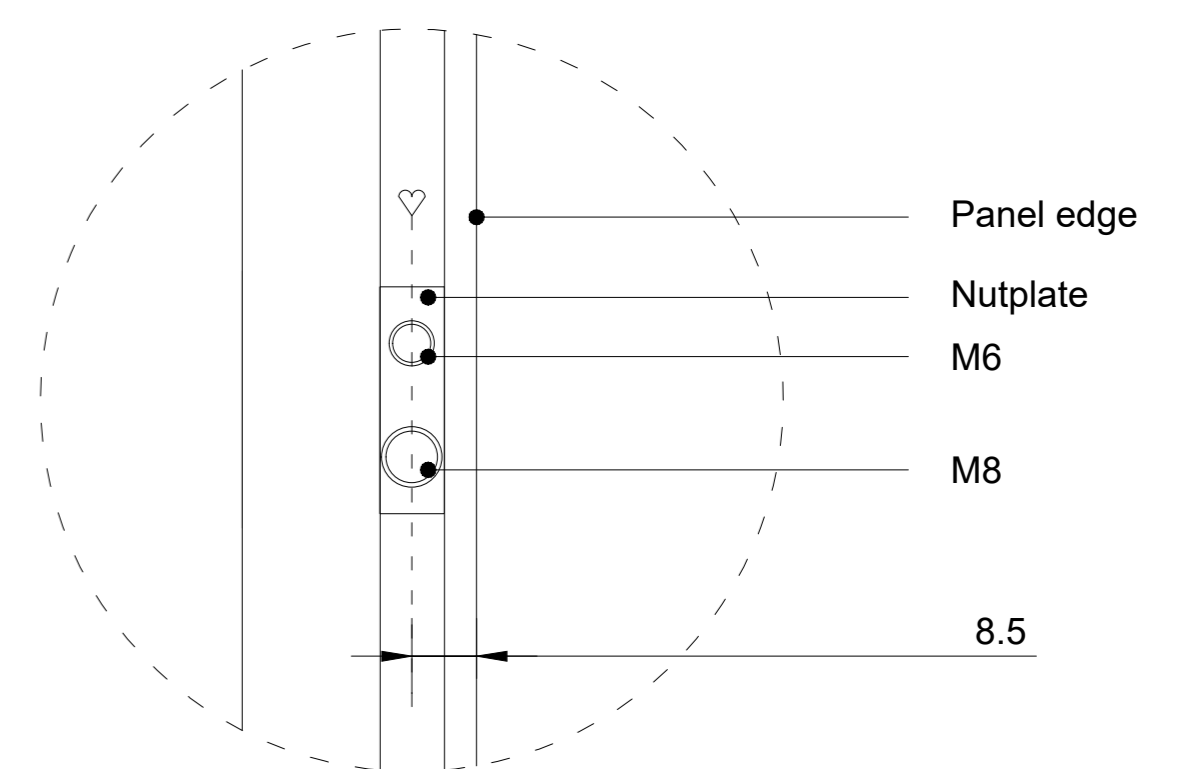

Backview (1:10)

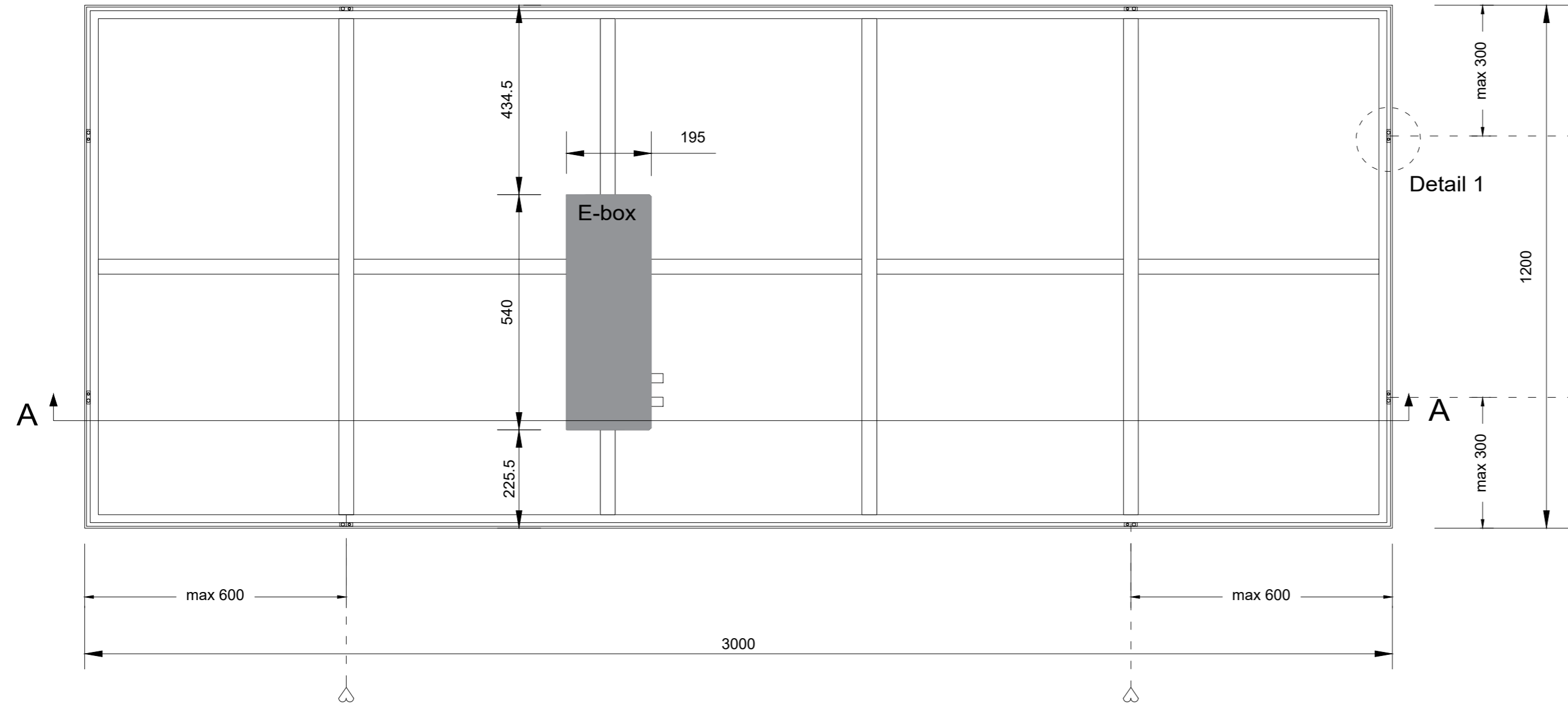

Sideview 2

Sideview 1 - mounting position (1:10)

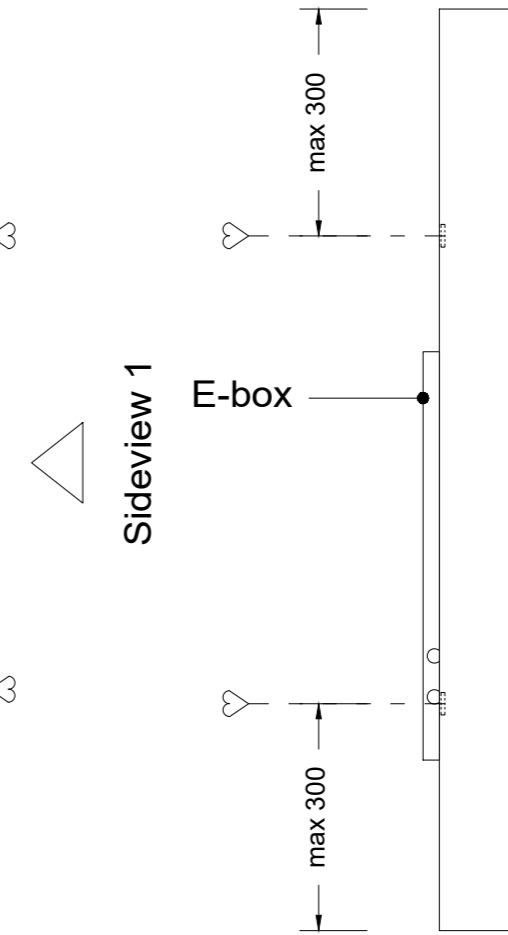

Sideview 2 - mounting position (1:10)

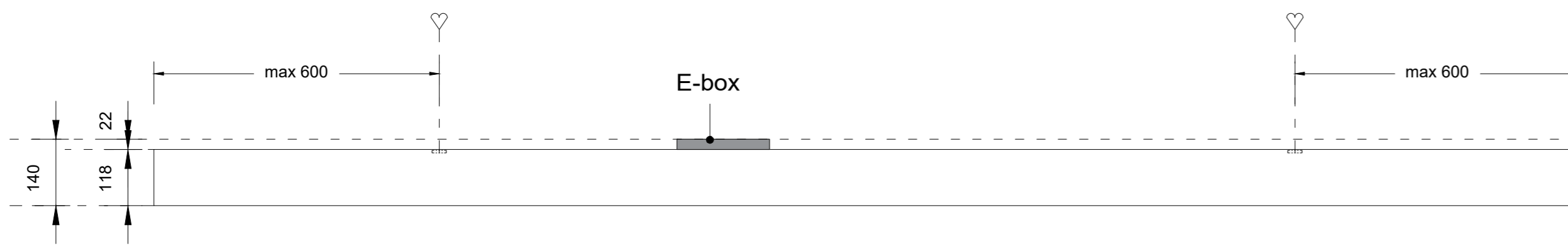

Section A-A (1:10)

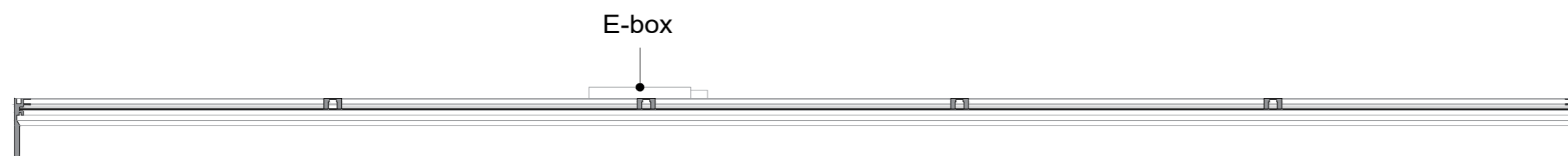

Detail 1 (1:1)

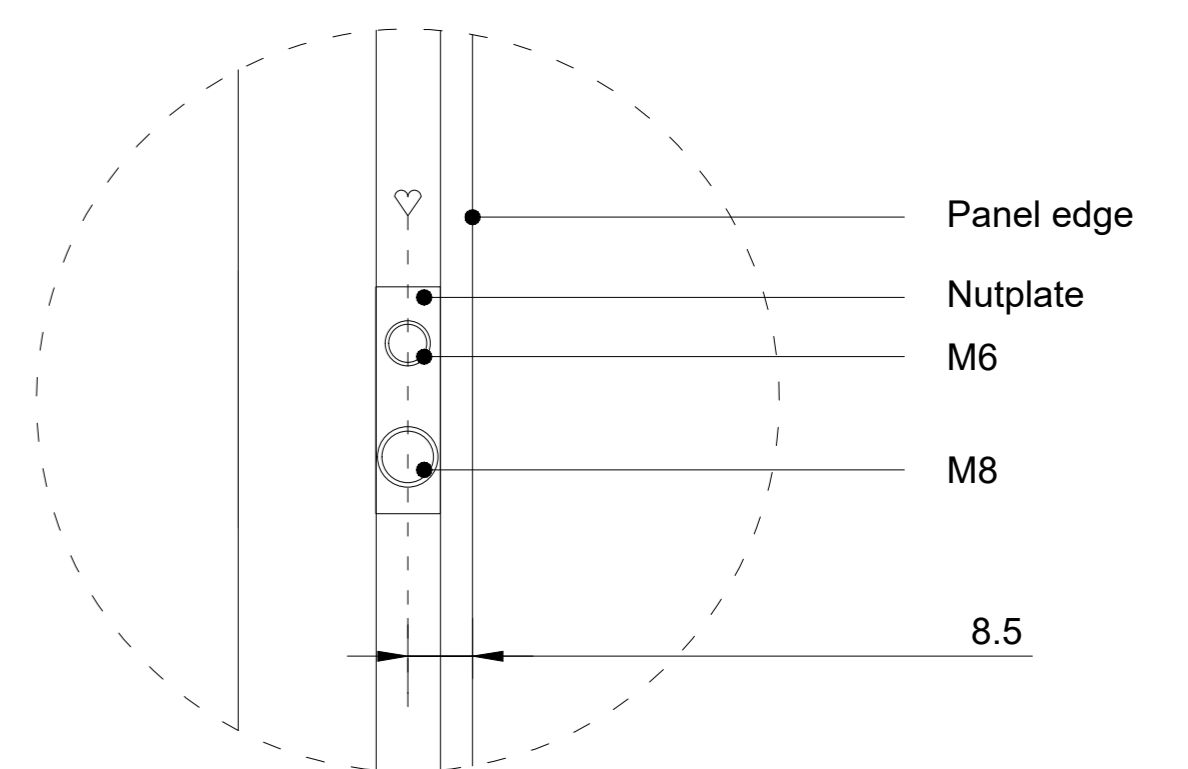



Backview (1:10)

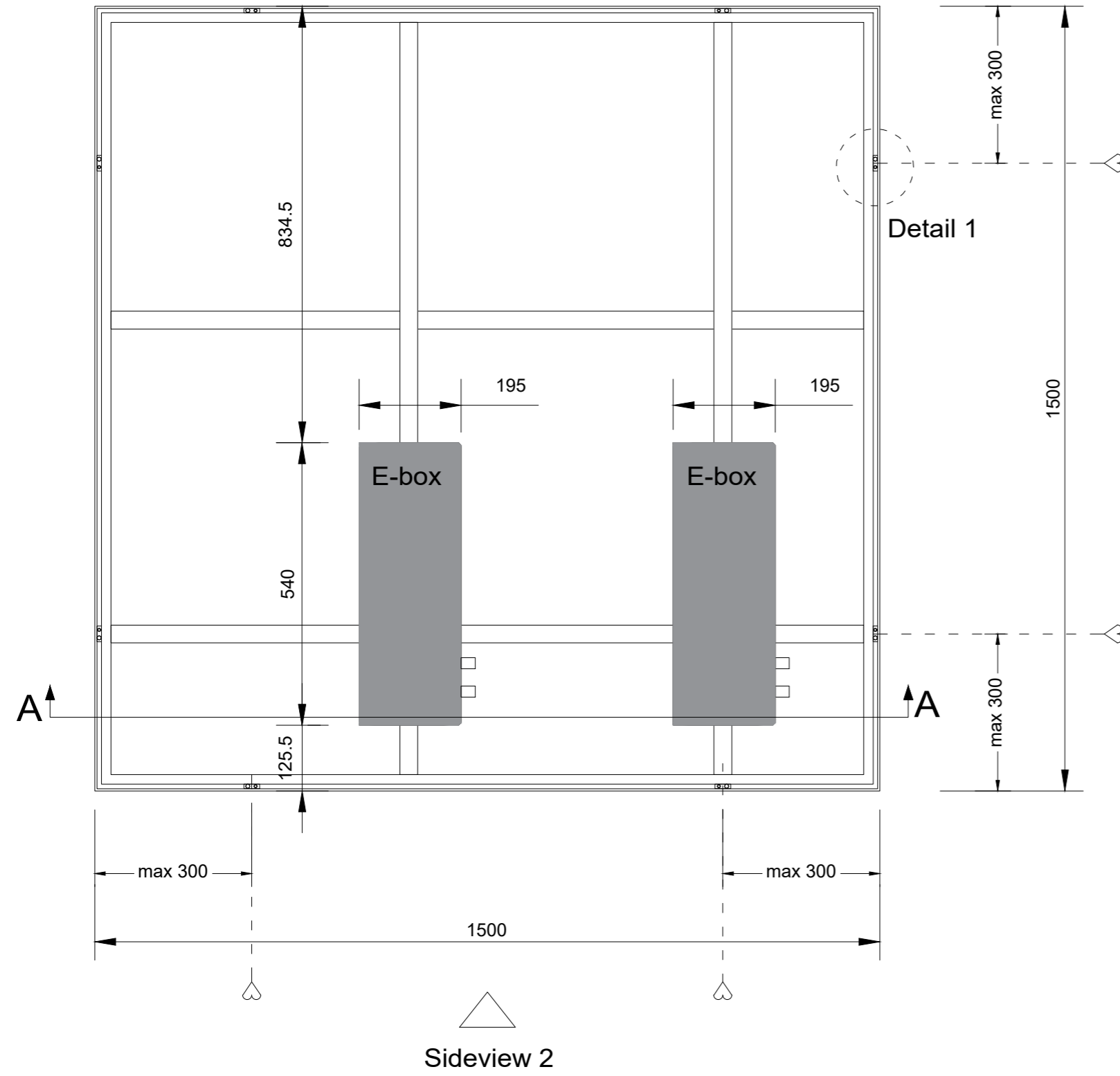

Sideview 1 - mounting position (1:10)

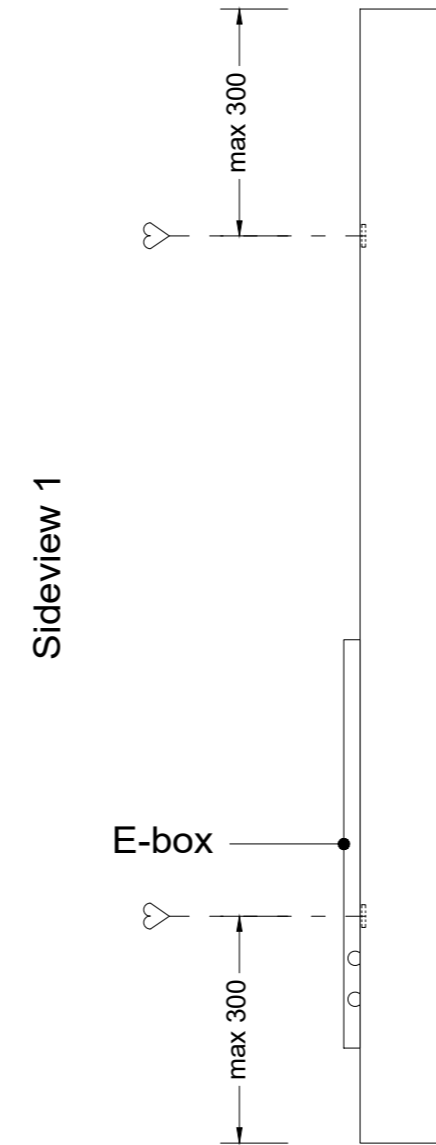

Sideview 2 - mounting position (1:10)

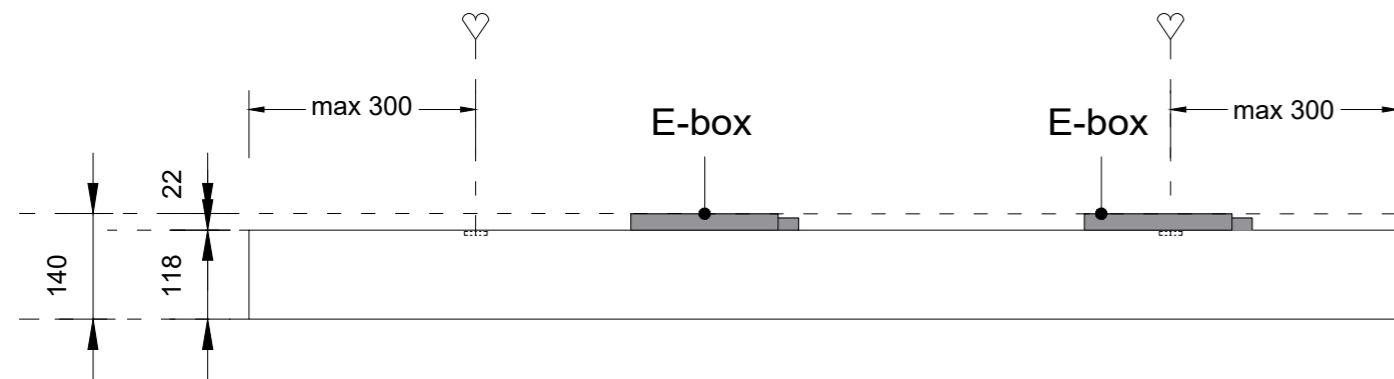

Section A-A (1:10)

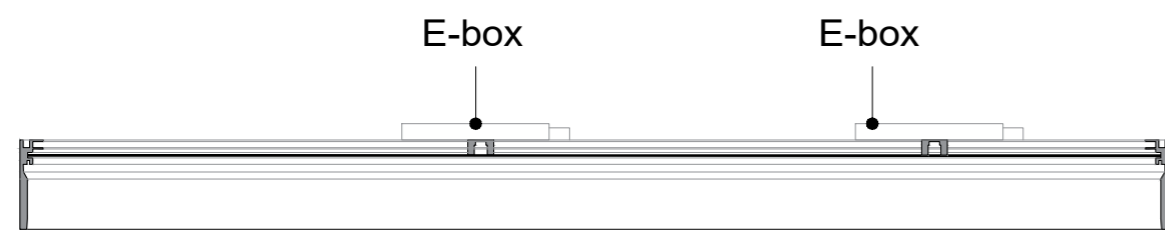

Detail 1 (1:1)

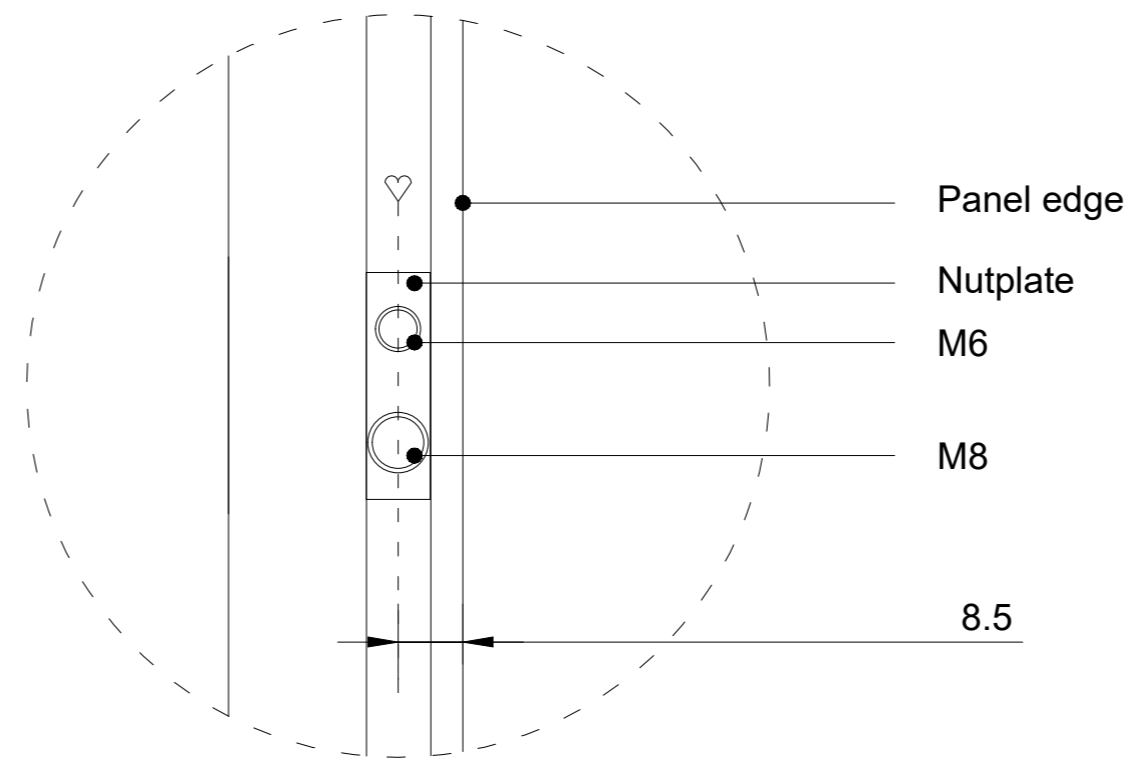

Backview (1:10)

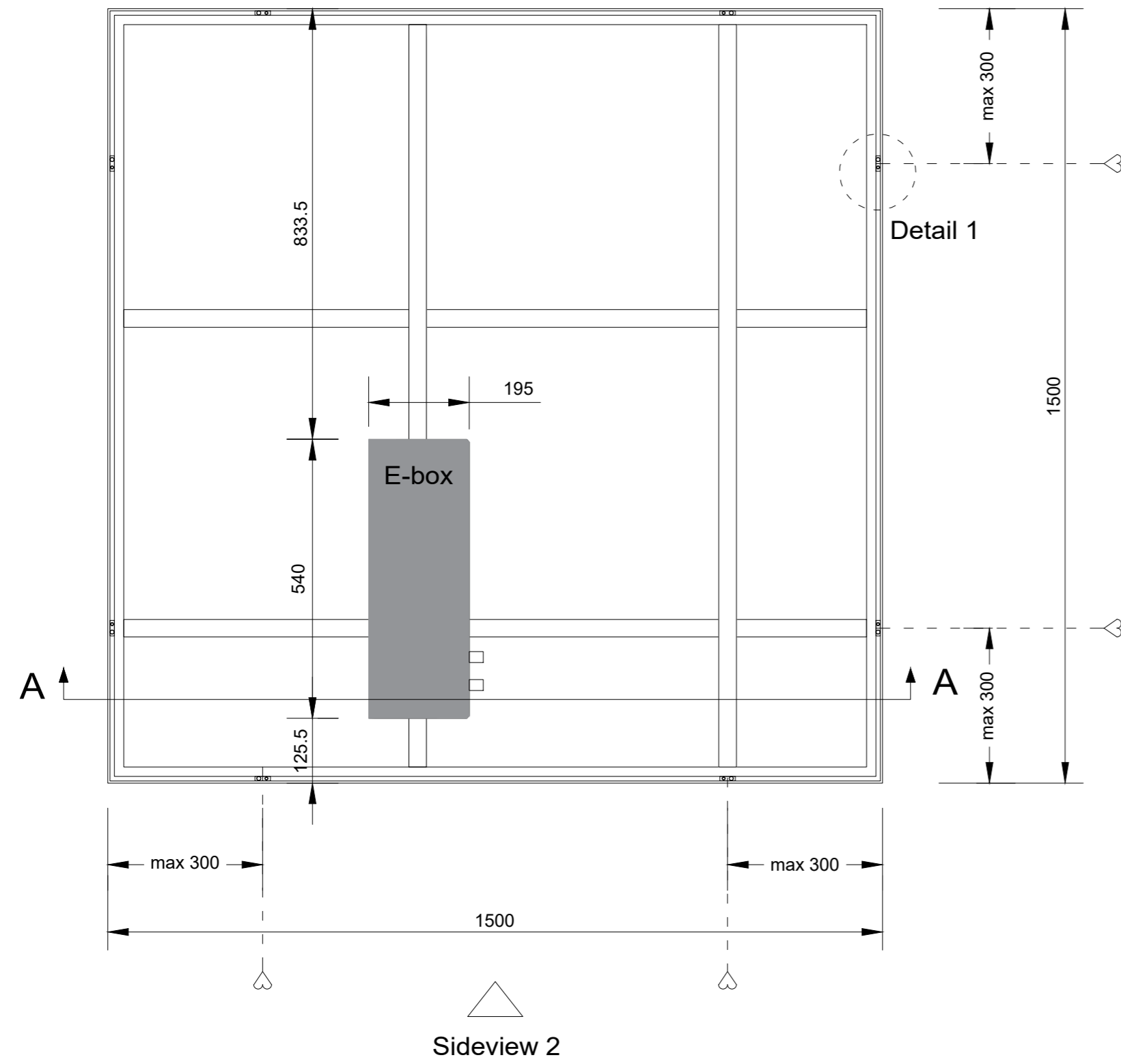

Sideview 1 - mounting position (1:10)

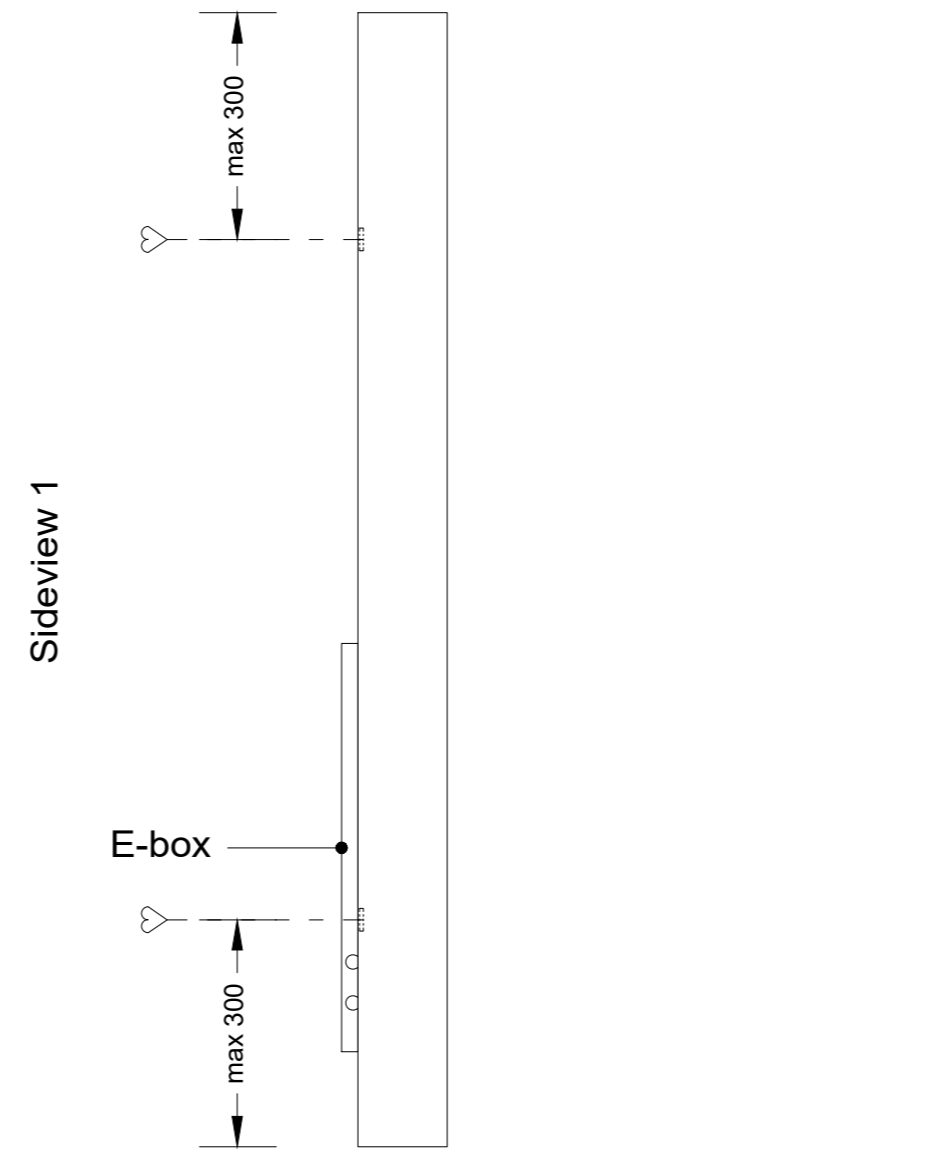

Sideview 2 - mounting position (1:10)

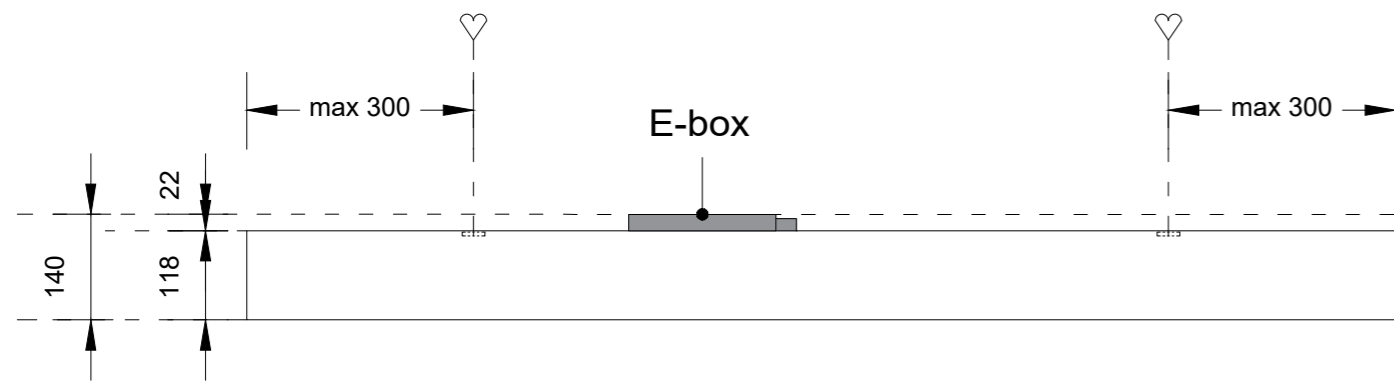

Section A-A (1:10)

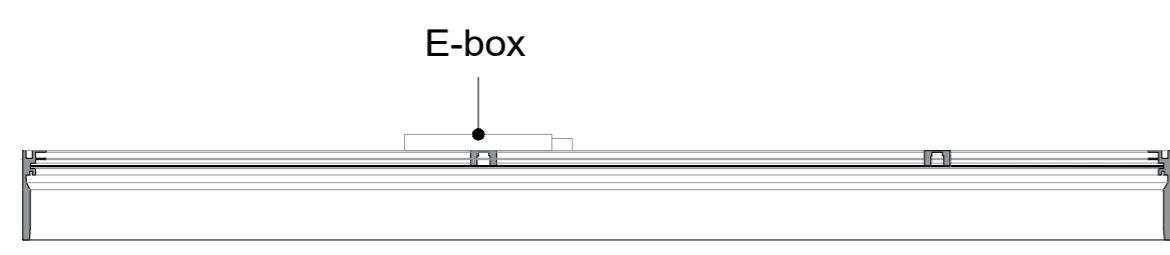

Detail 1 (1:1)

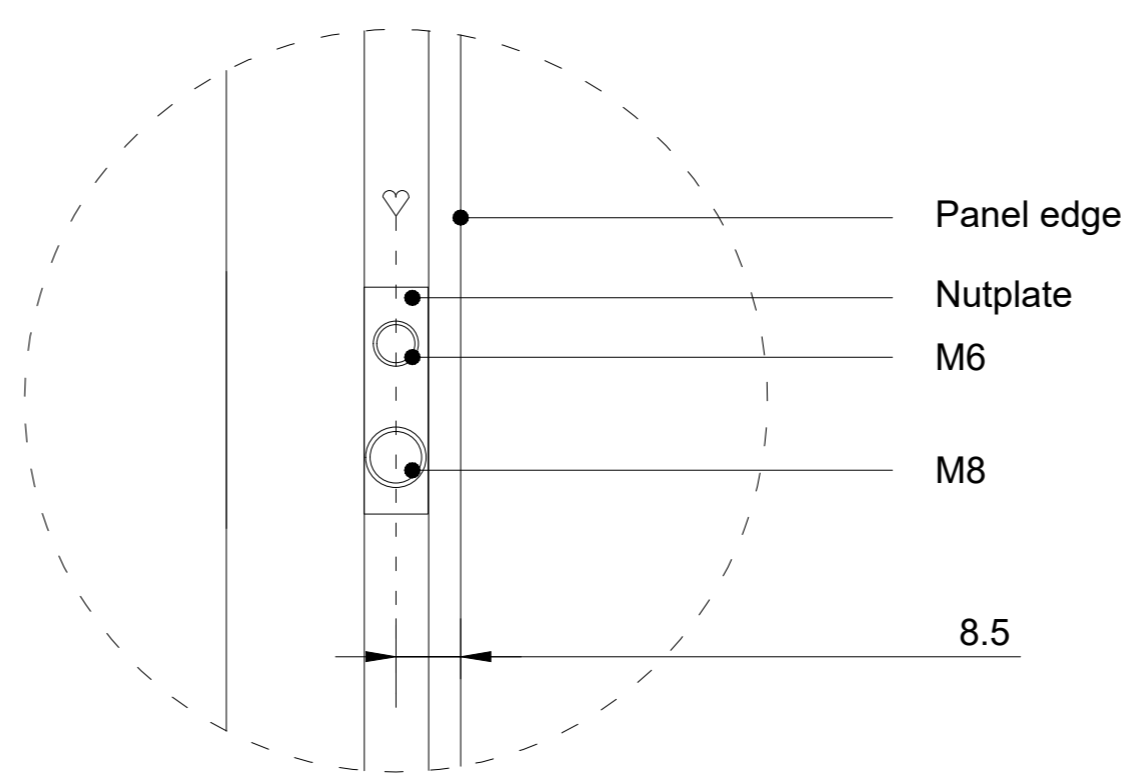

Backview (1:10)

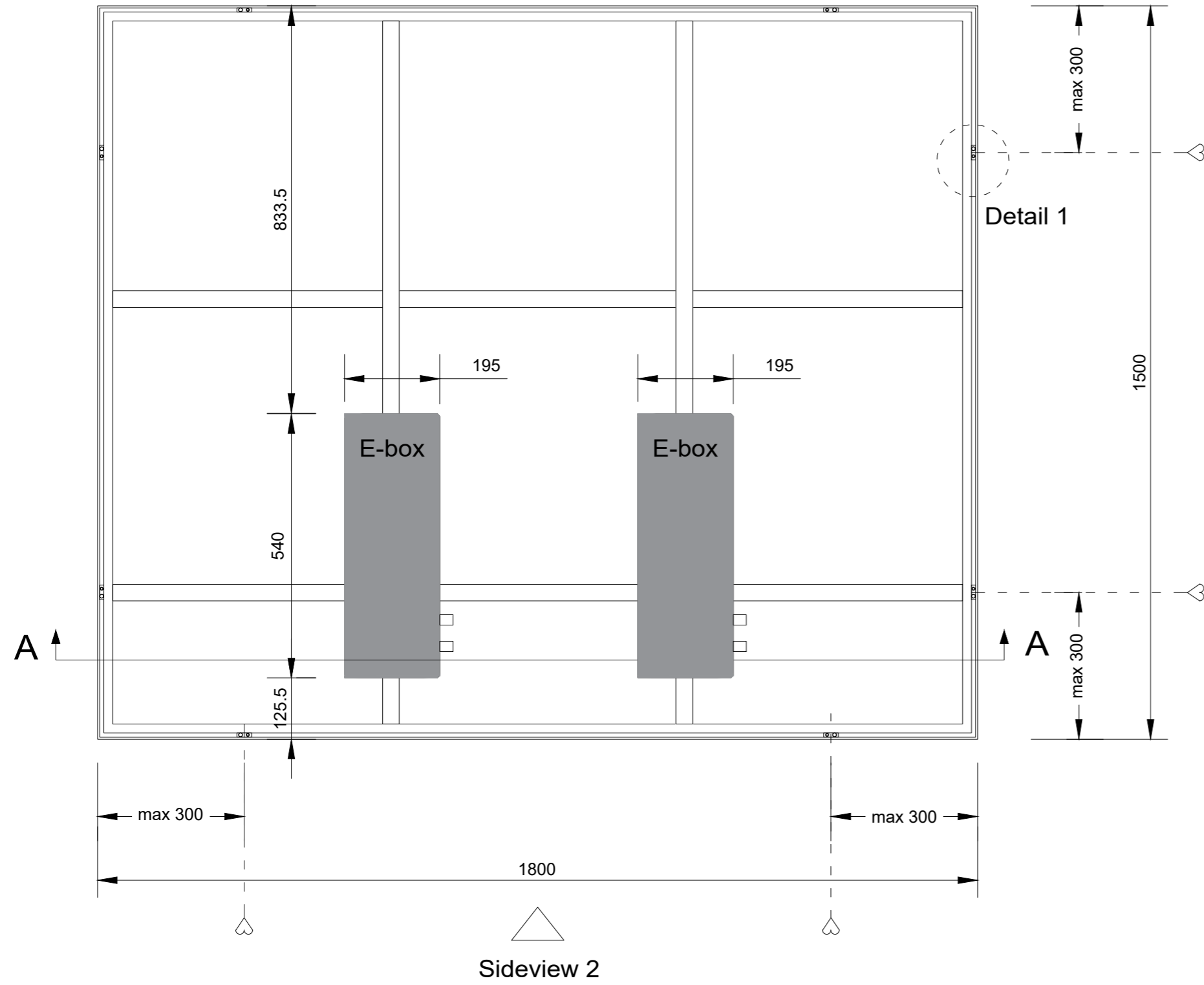

Sideview 1 - mounting position (1:10)

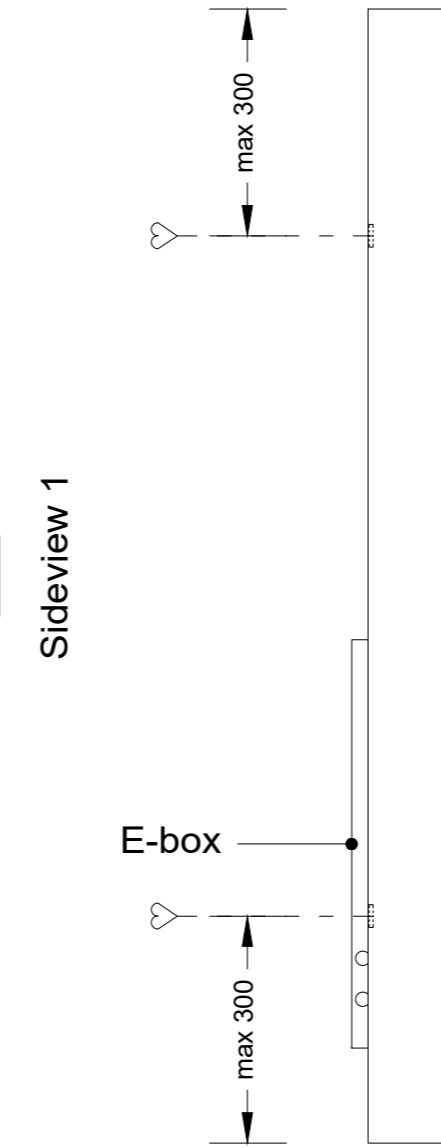

Sideview 2 - mounting position (1:10)

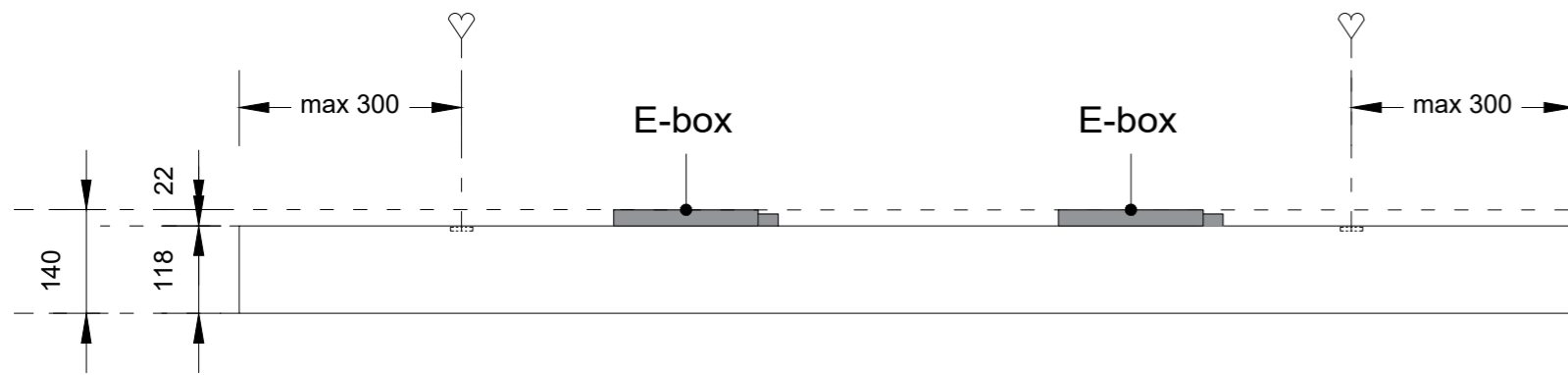

Section A-A (1:10)

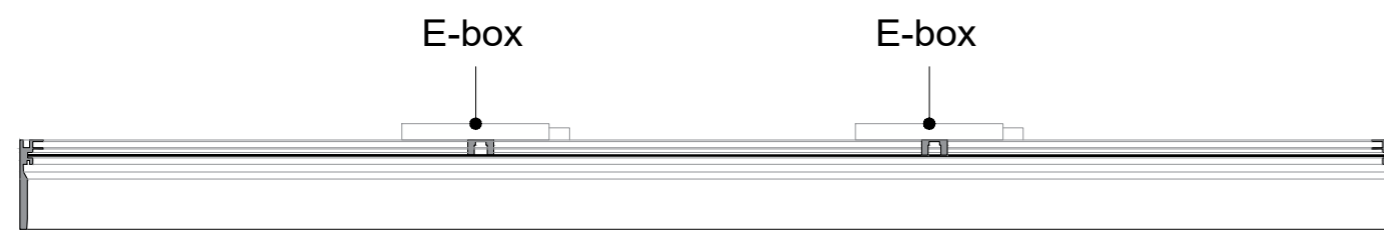

Detail 1 (1:1)

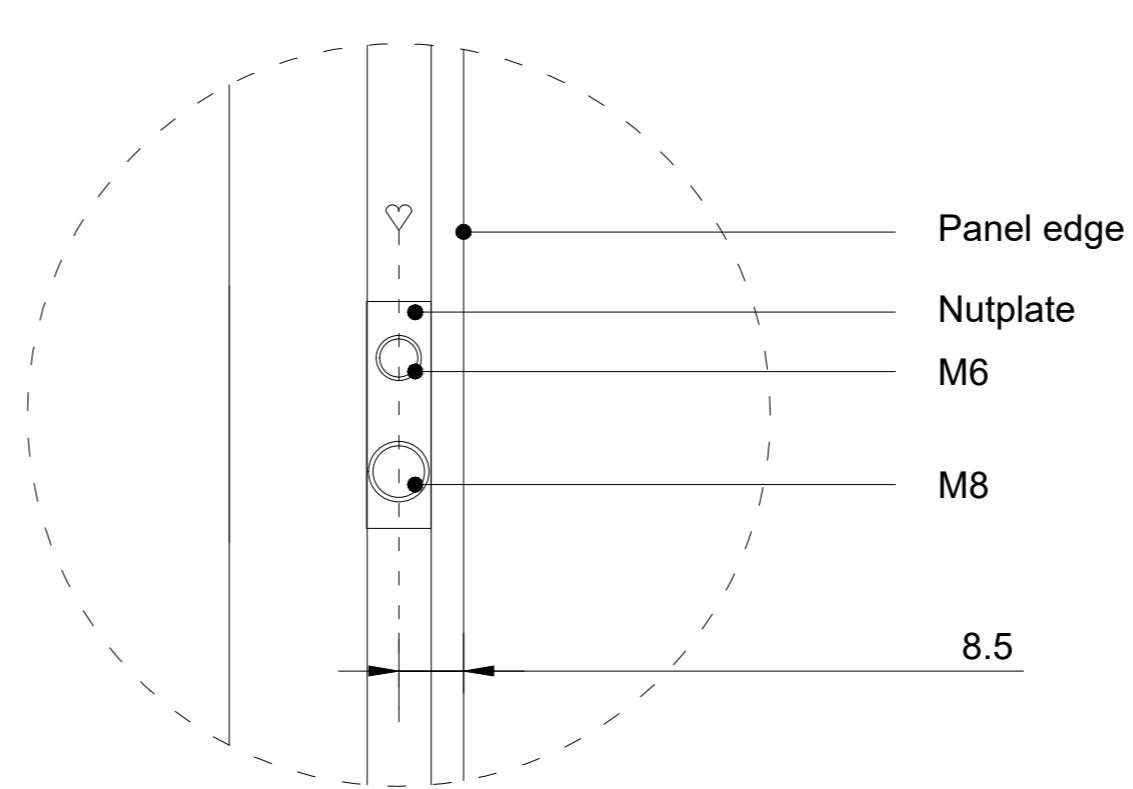

Backview (1:10)

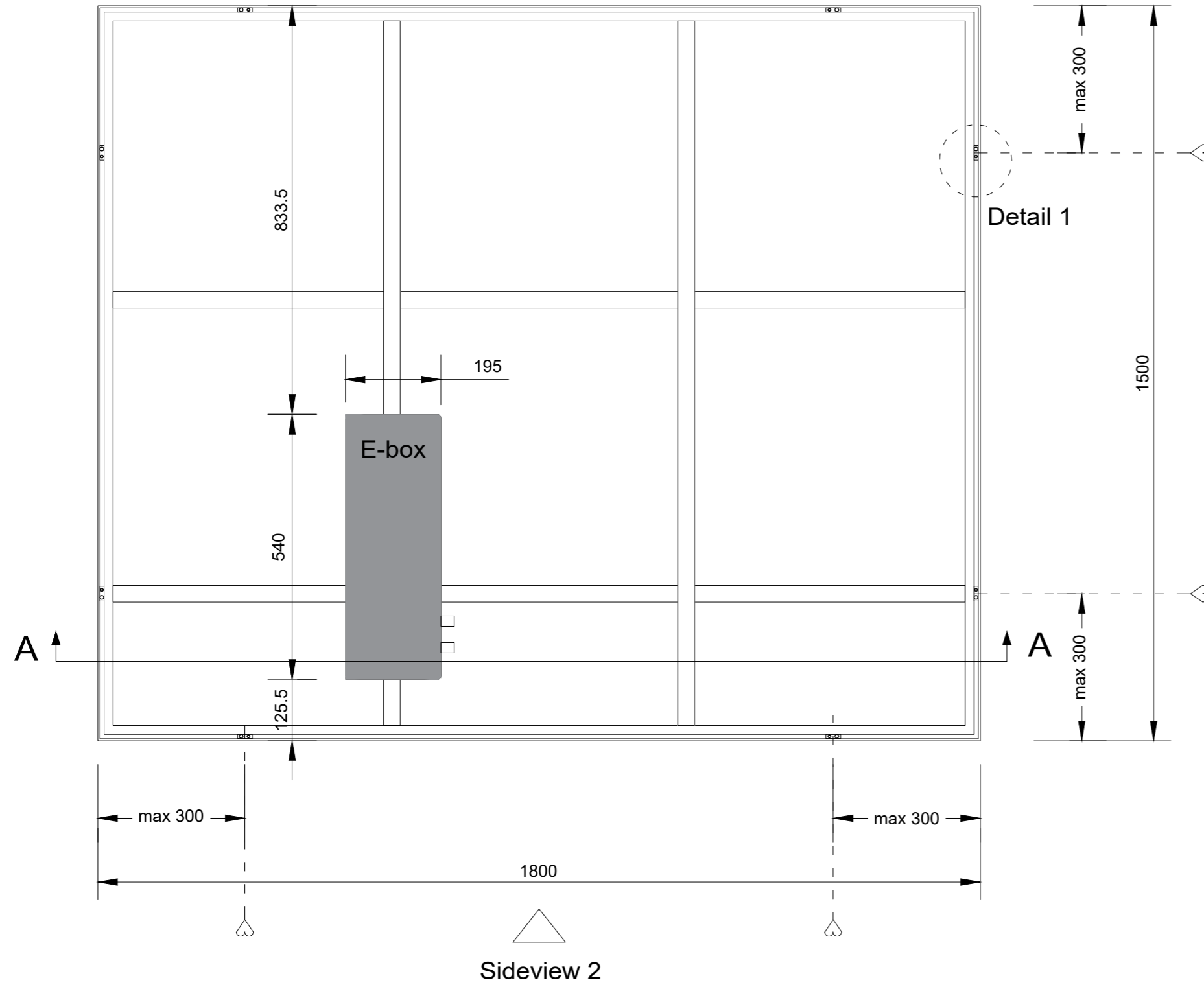

Sideview 1 - mounting position (1:10)

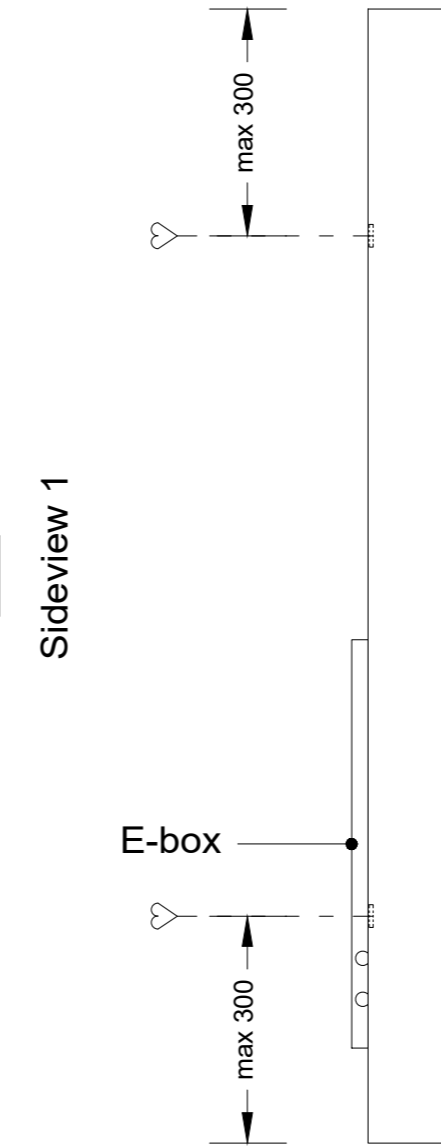

Sideview 2 - mounting position (1:10)

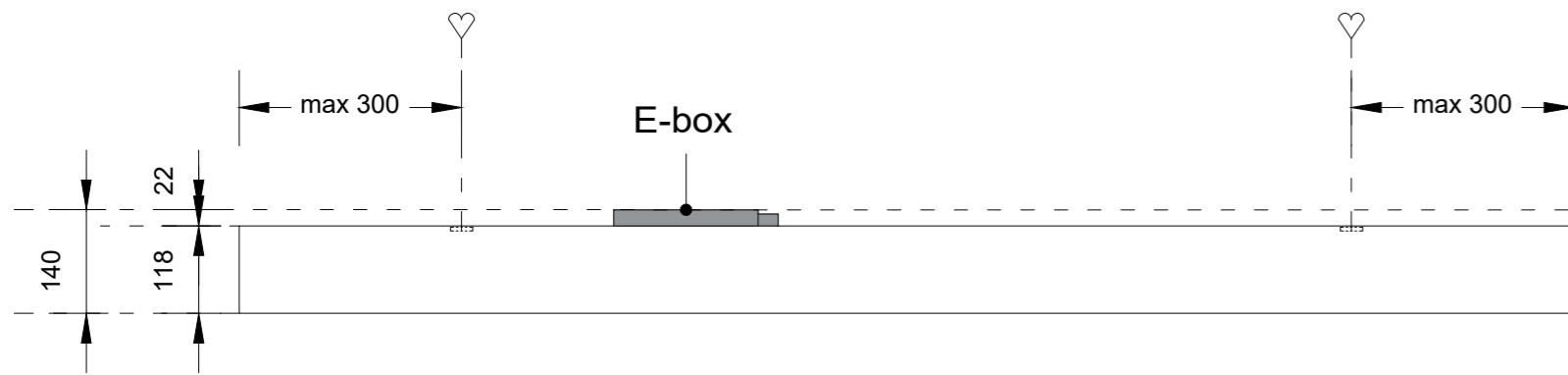

Section A-A (1:10)

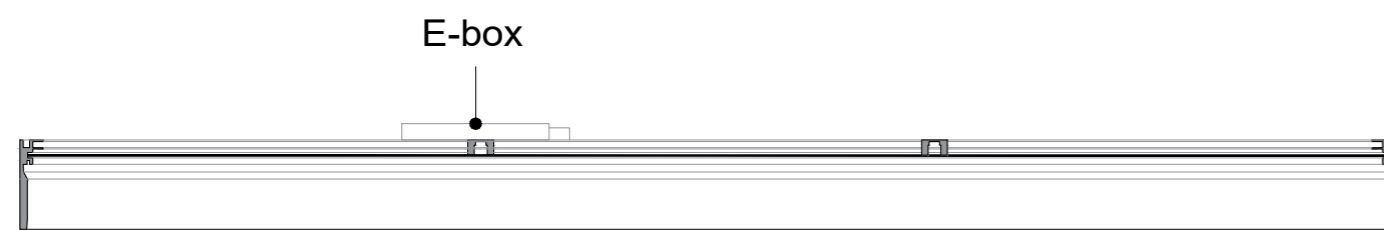

Detail 1 (1:1)

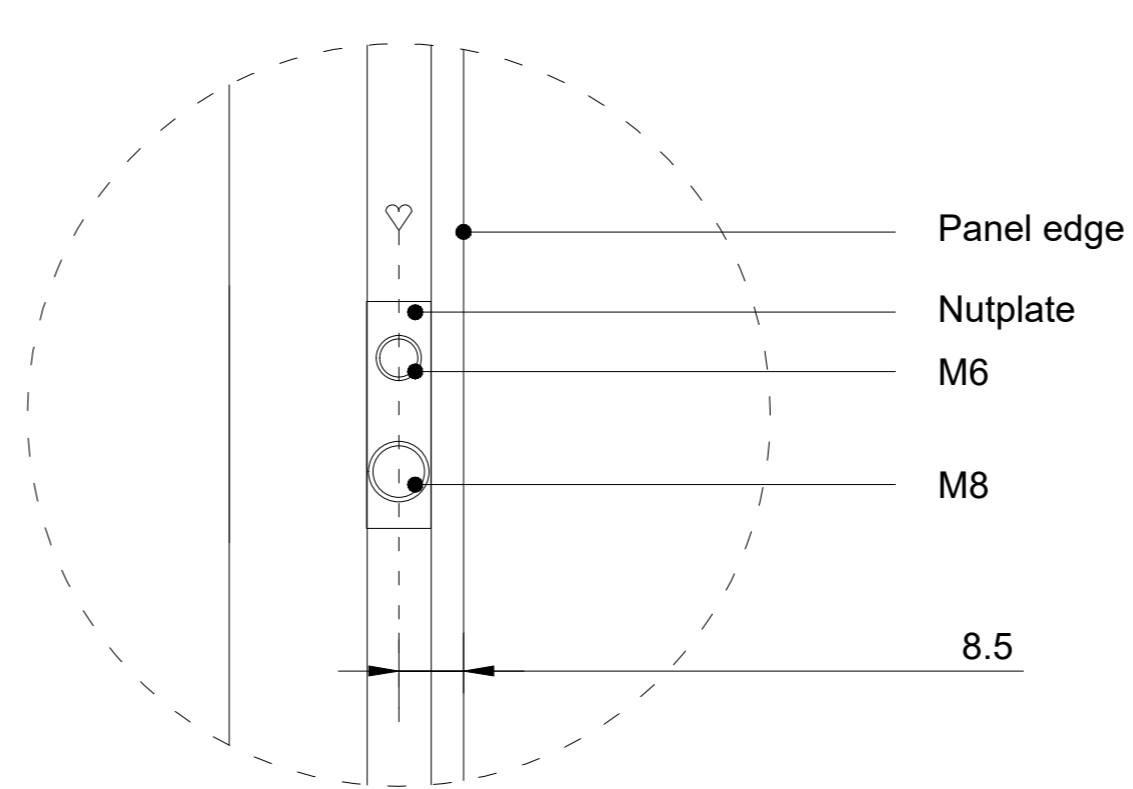

Backview (1:10)

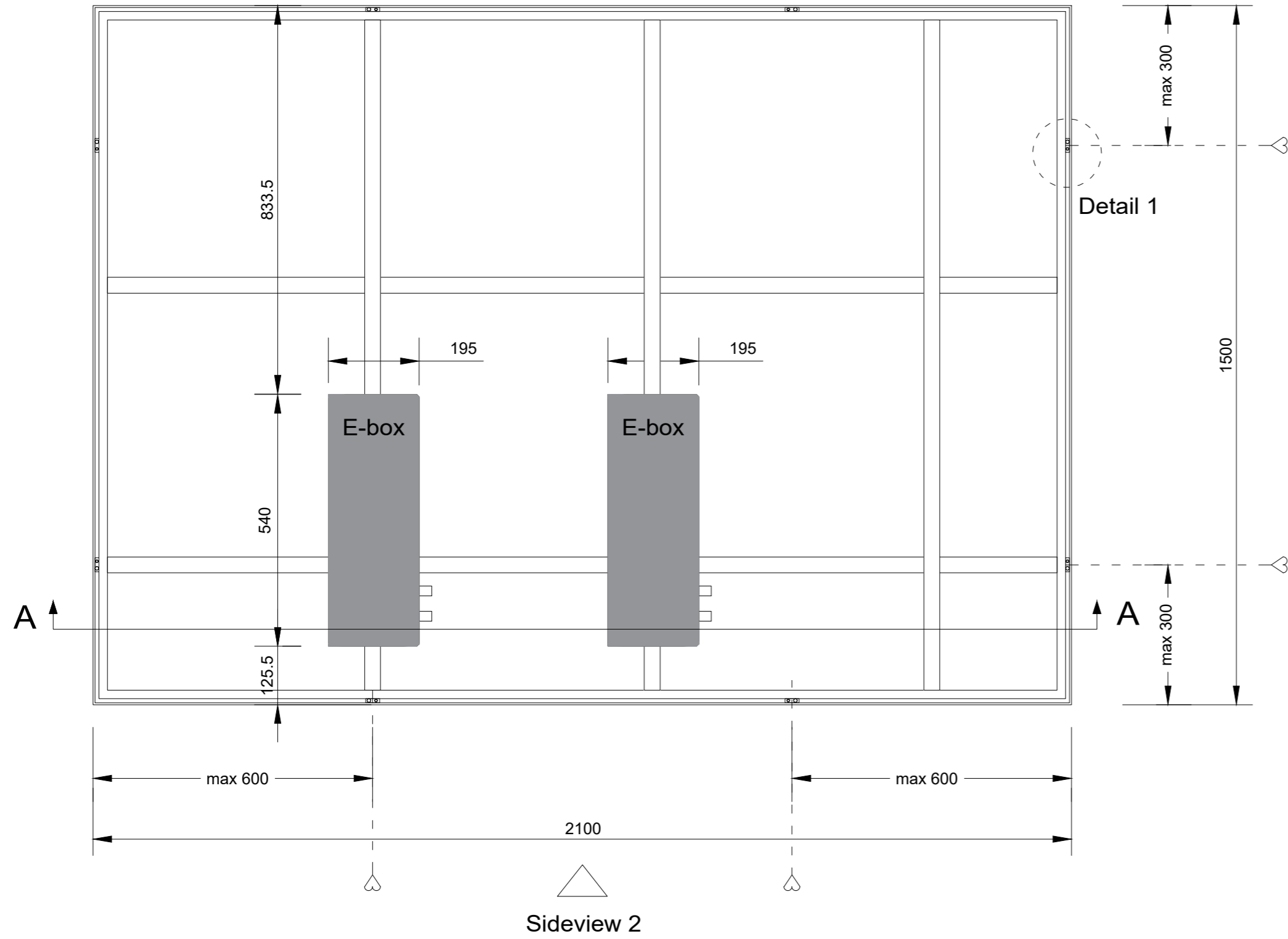

Sideview 1 - mounting position (1:10)

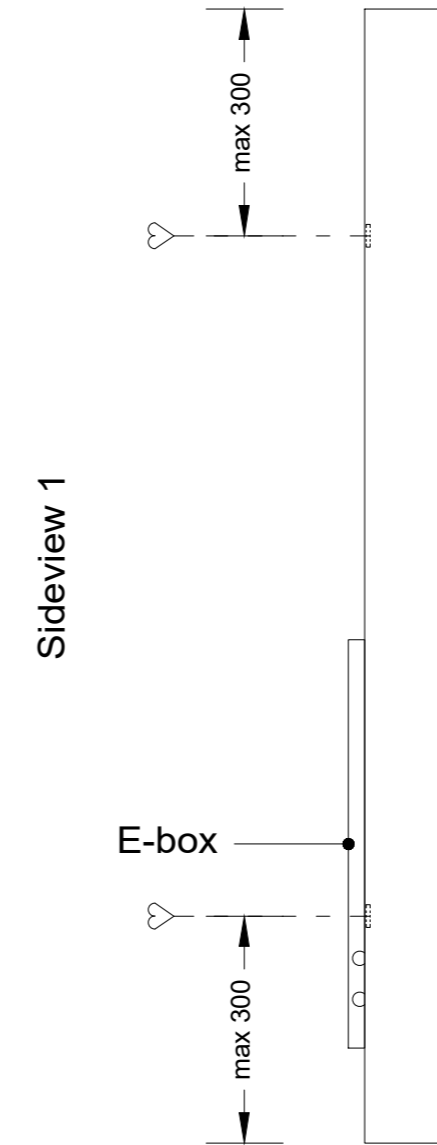

Sideview 2 - mounting position (1:10)

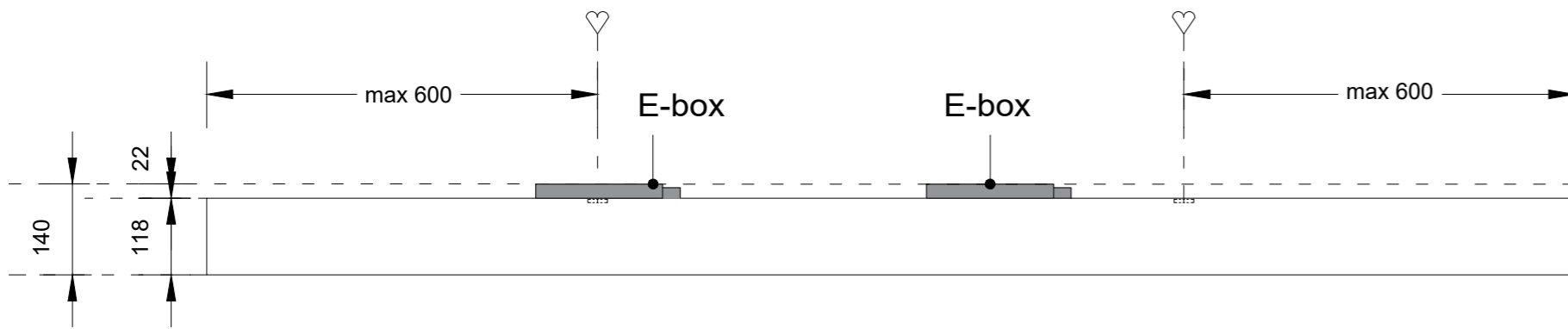

Section A-A (1:10)

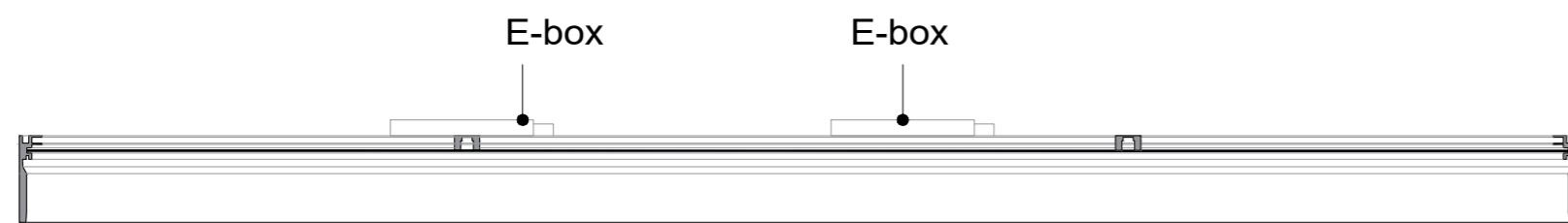

Detail 1 (1:1)

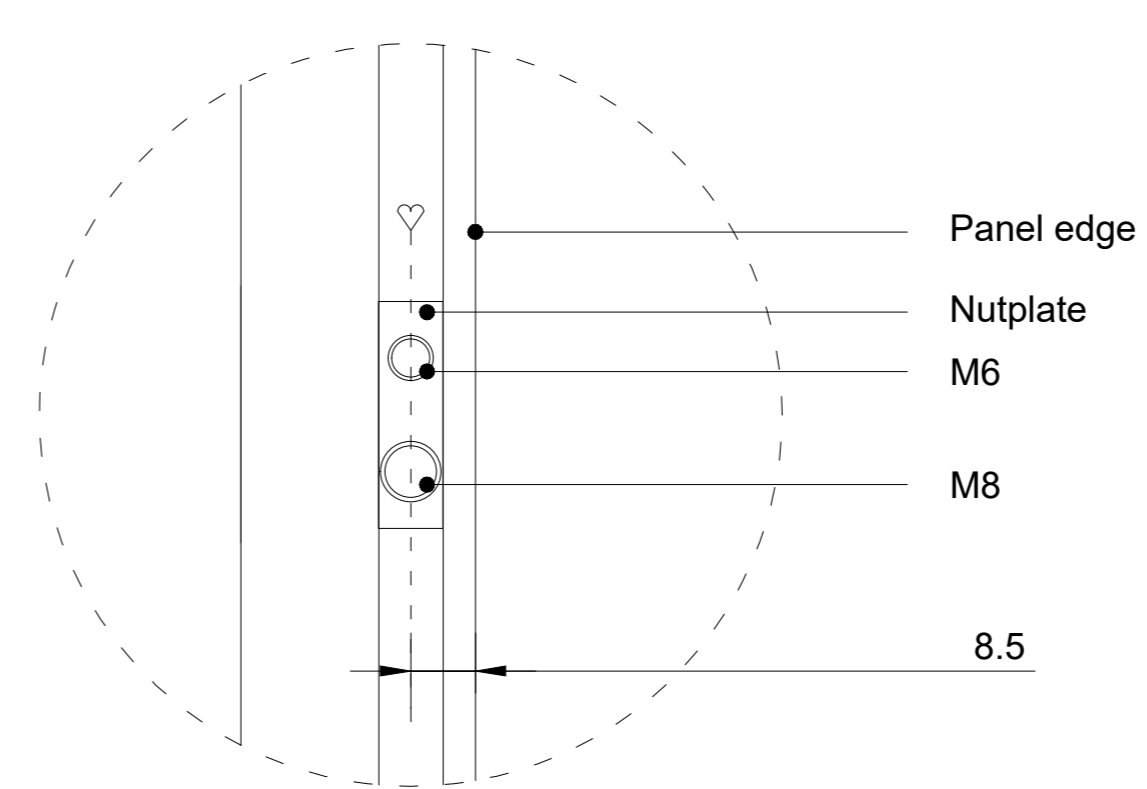

Backview (1:10)

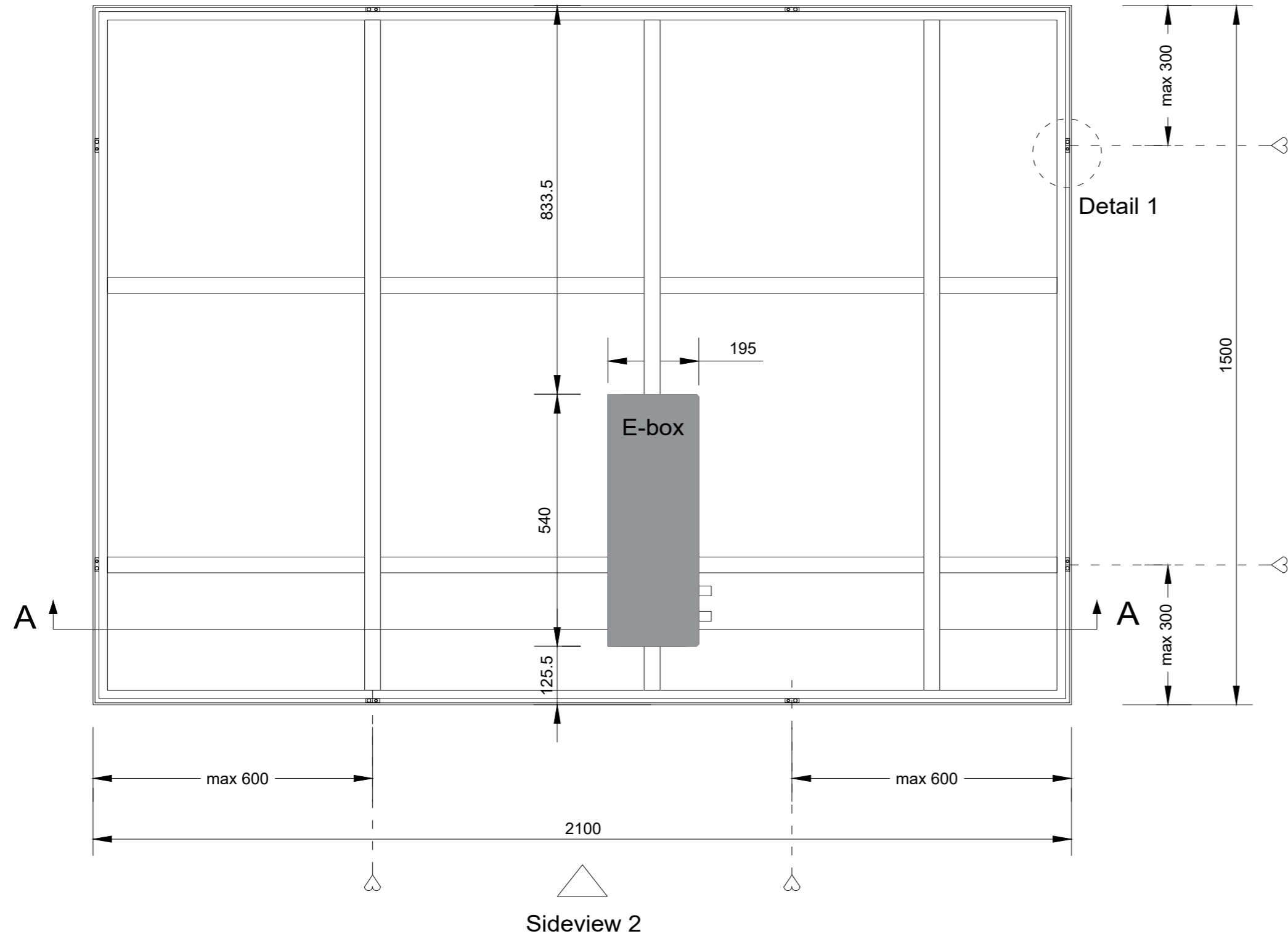

Sideview 1 - mounting position (1:10)

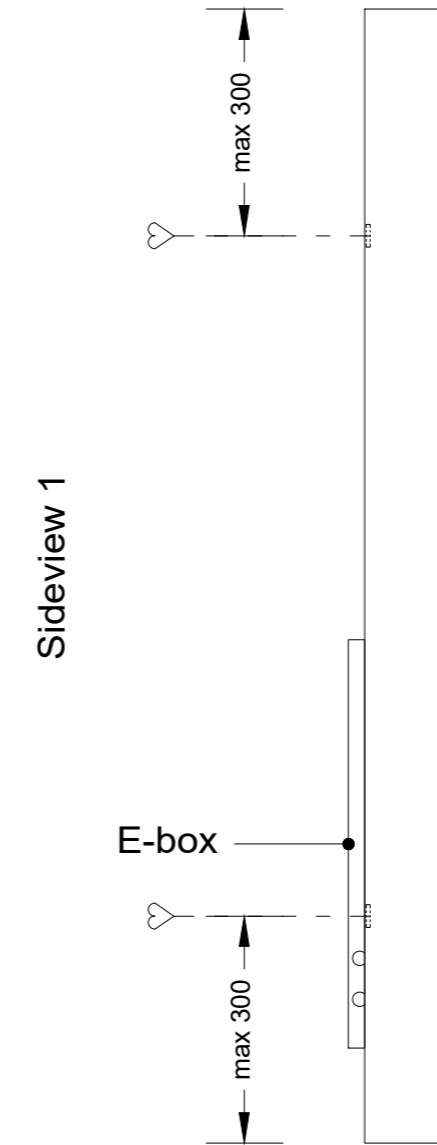

Sideview 2 - mounting position (1:10)

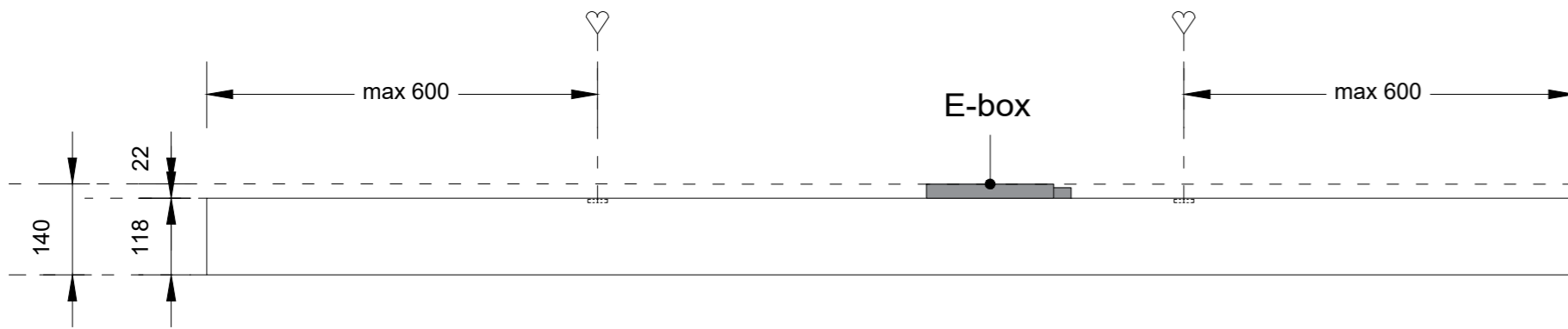

Section A-A (1:10)

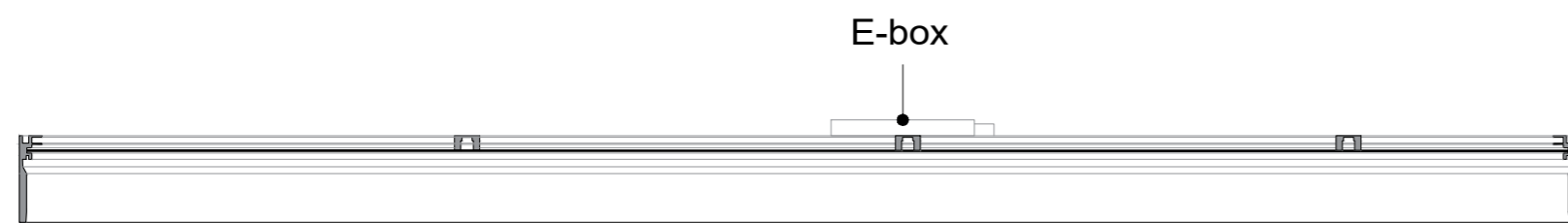

Detail 1 (1:1)

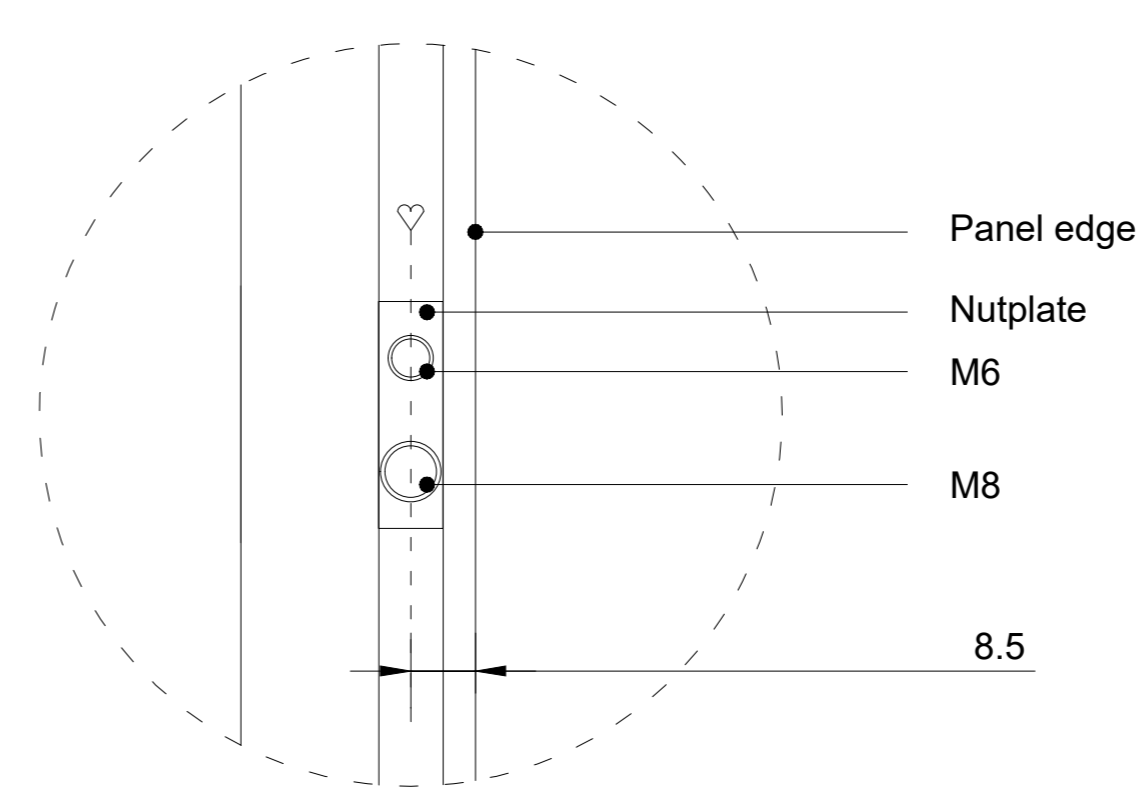

Backview (1:10)

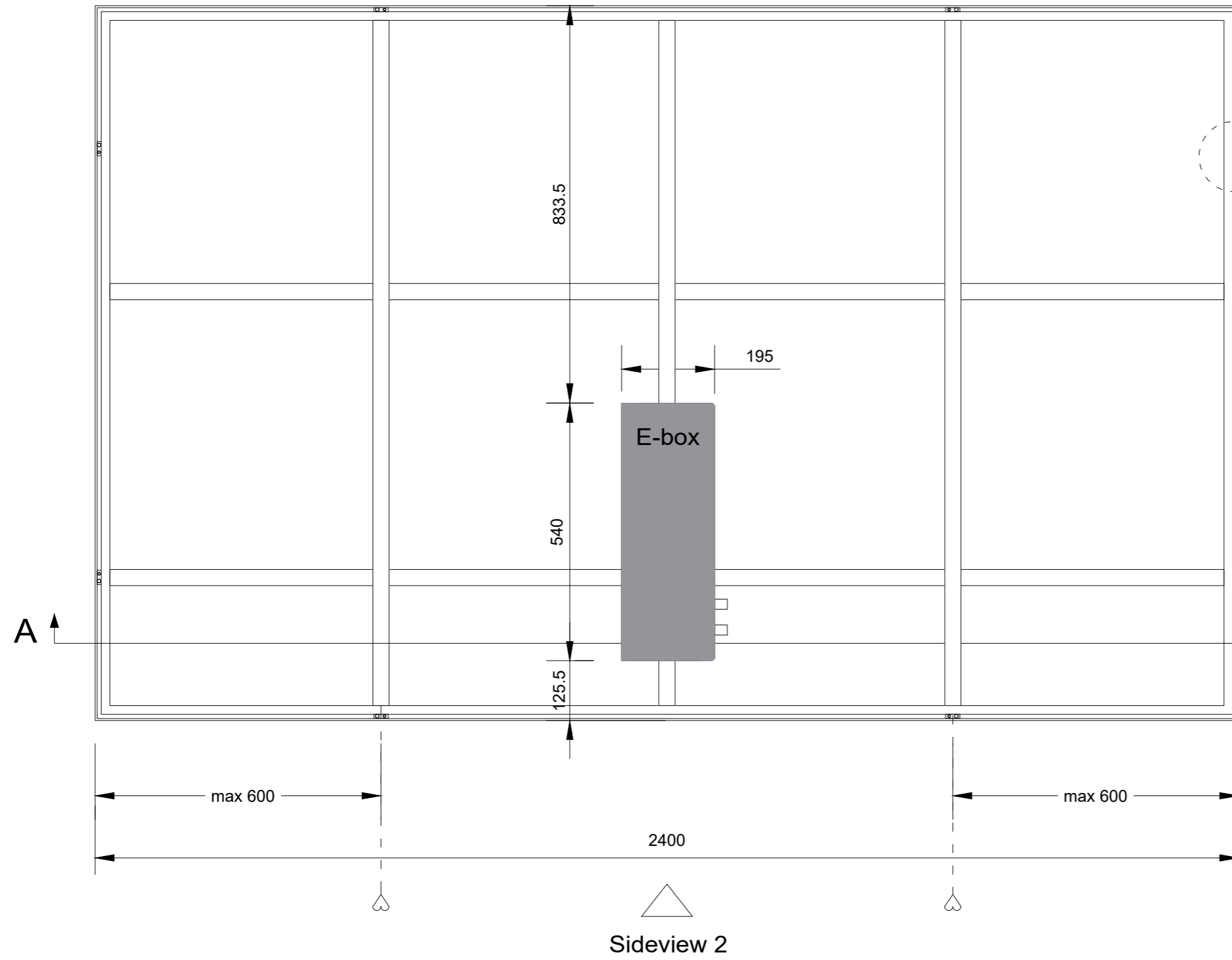

Sideview 1 - mounting position (1:10)

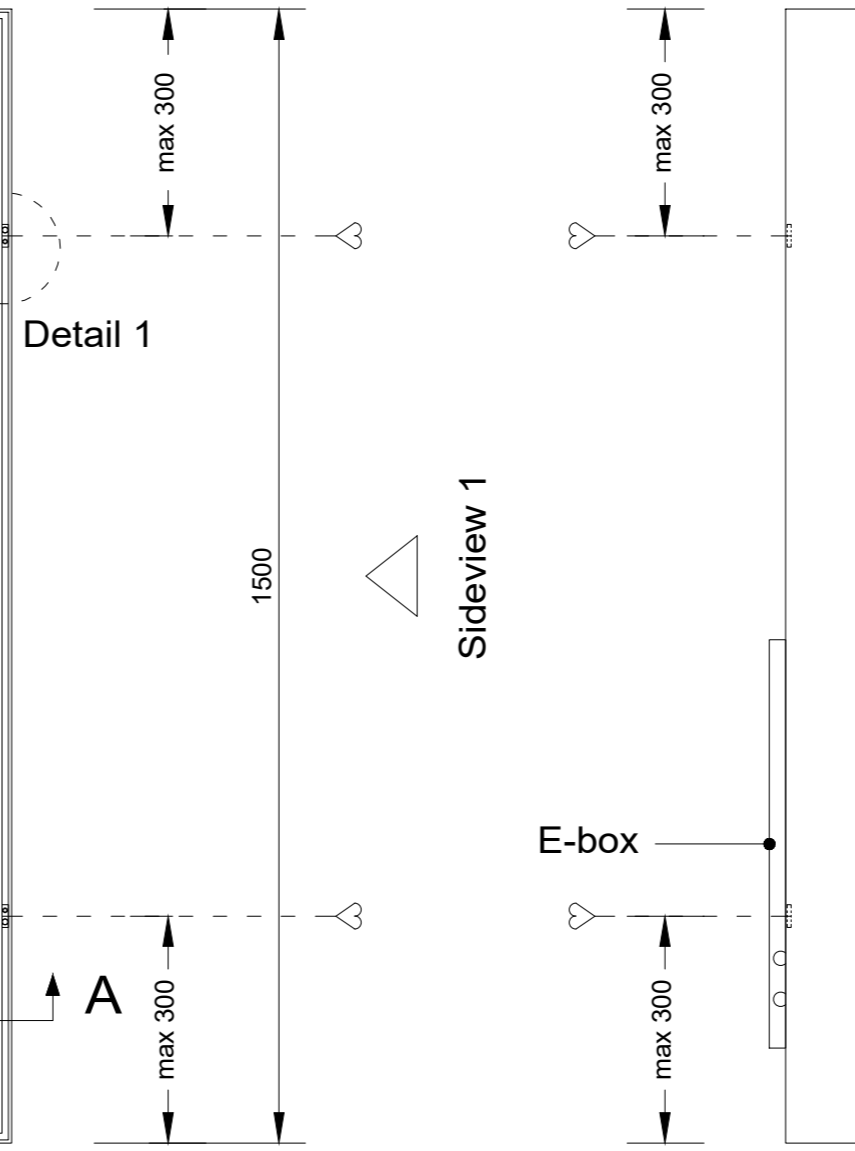

Sideview 2 - mounting position (1:10)

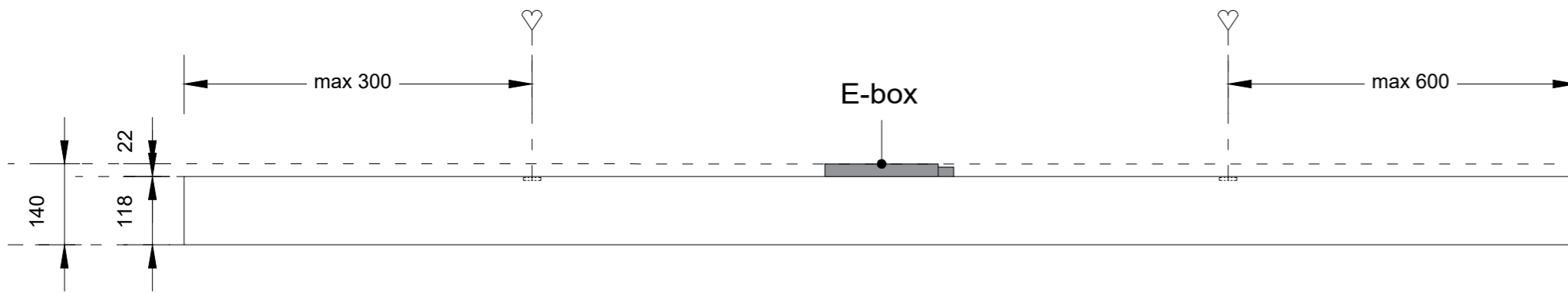

Section A-A (1:10)

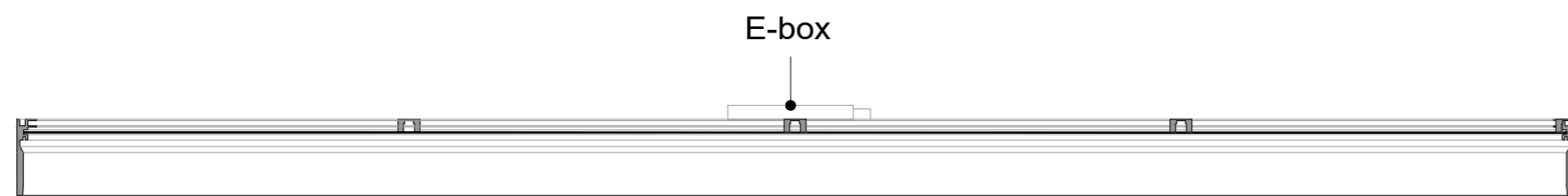

Detail 1 (1:1)

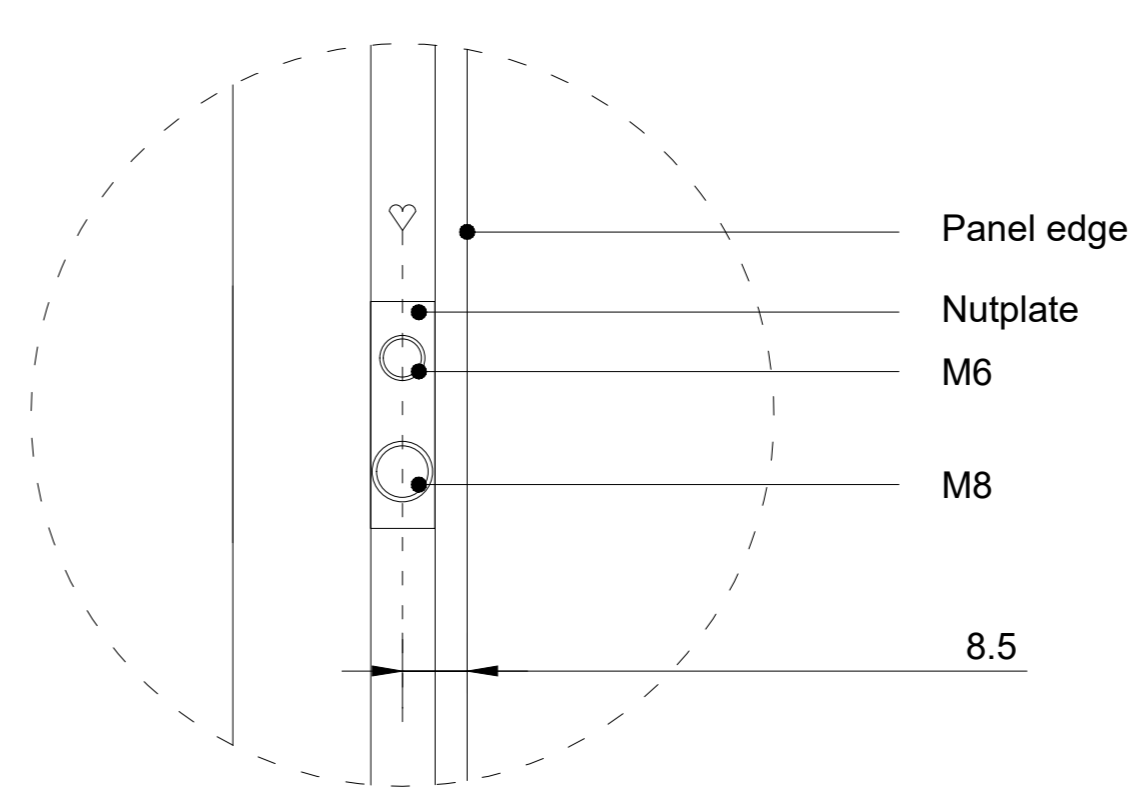

Backview (1:10)

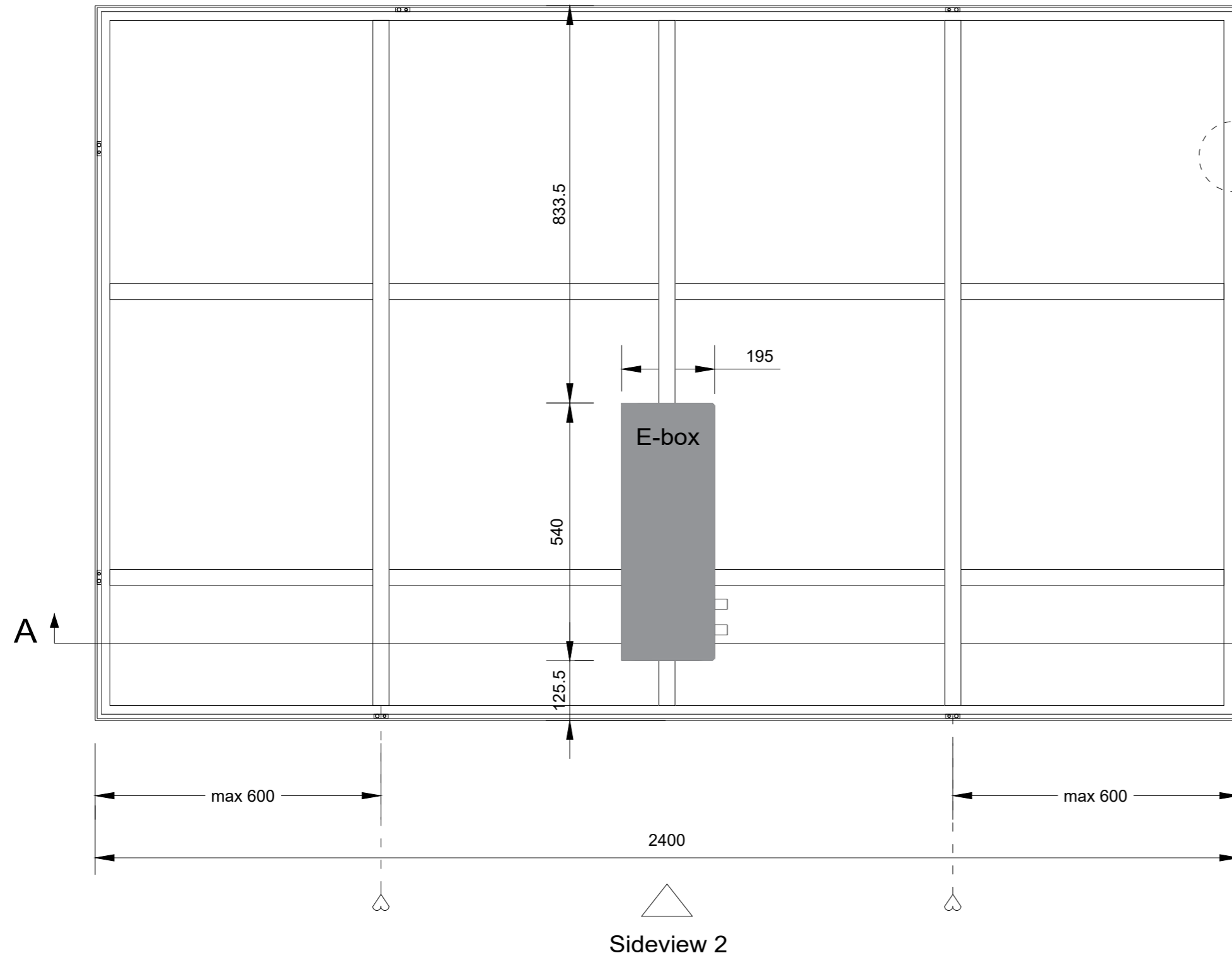

Sideview 1 - mounting position (1:10)

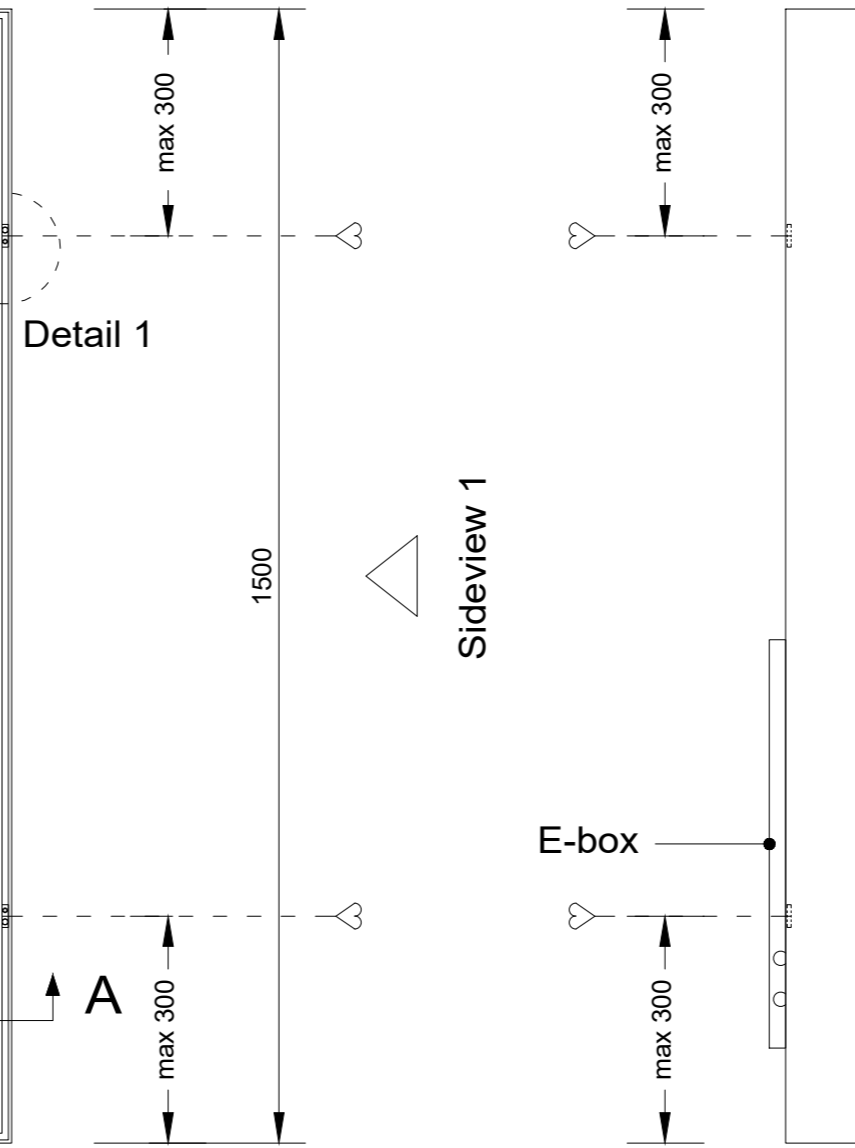

Sideview 2 - mounting position (1:10)

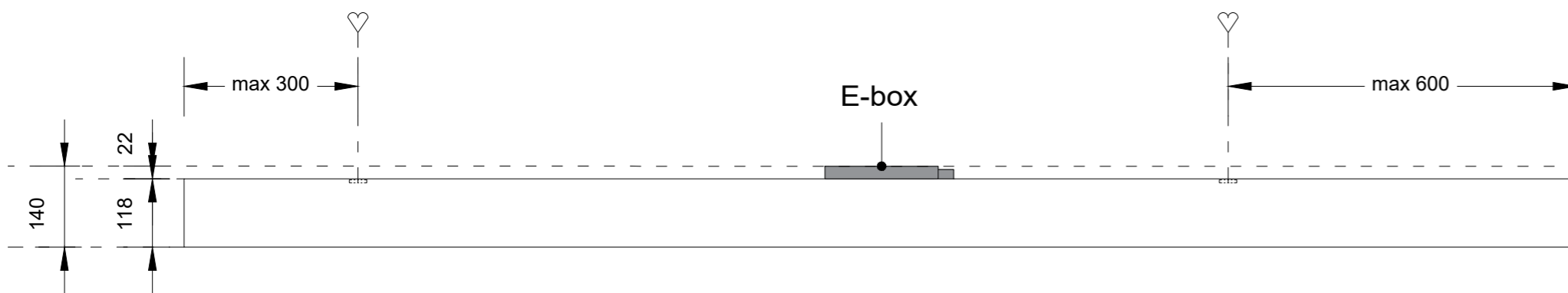

Section A-A (1:10)

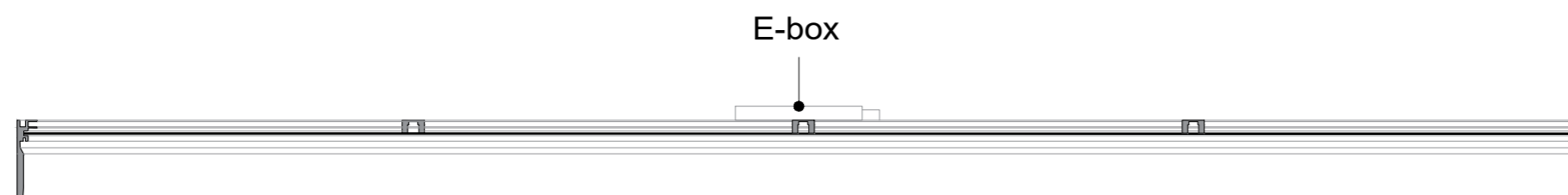

Detail 1 (1:1)

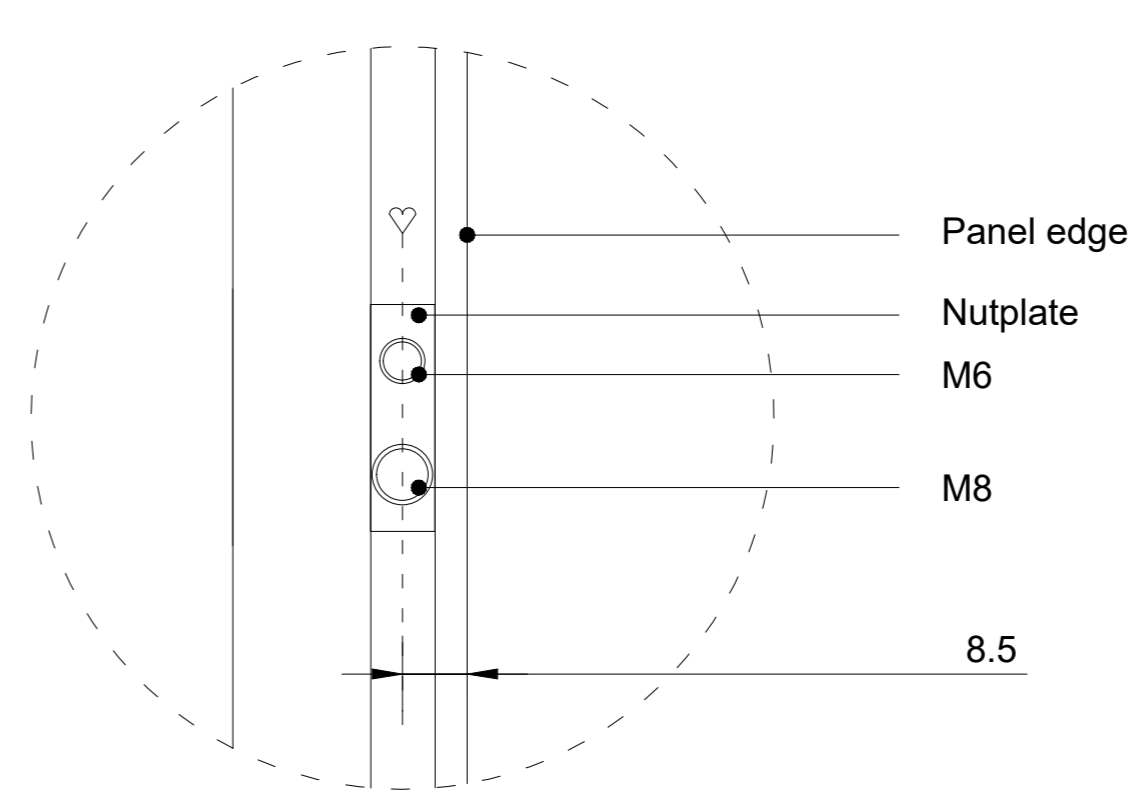



Backview (1:10)

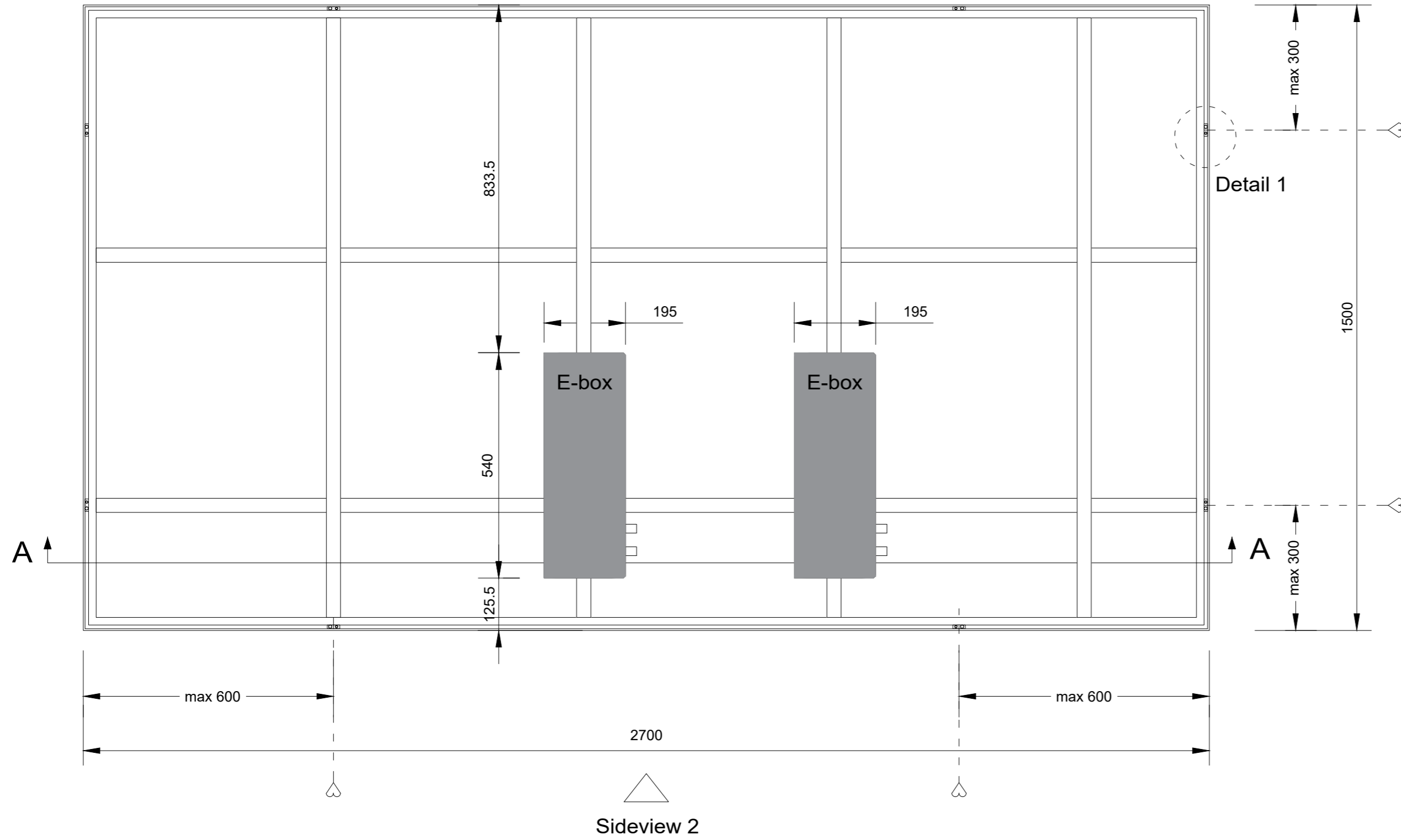

Sideview 1 - mounting position (1:10)

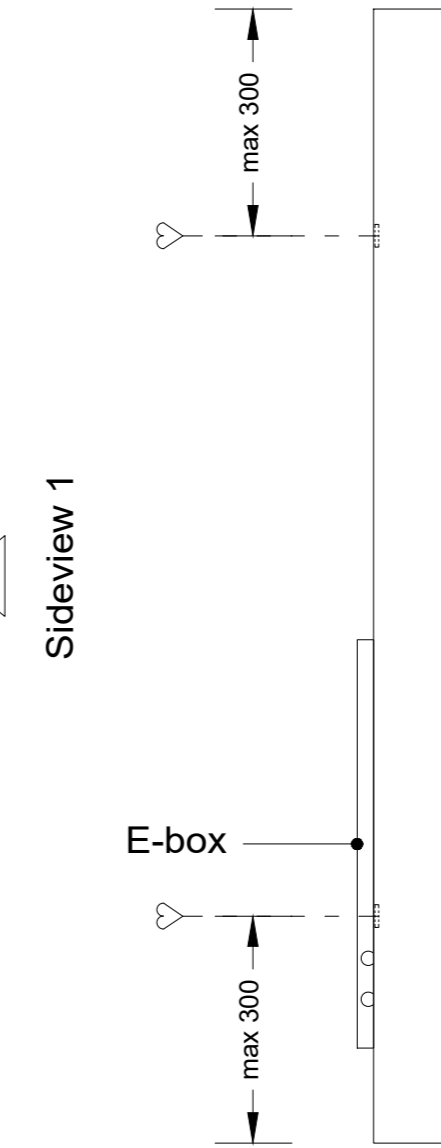

Sideview 2 - mounting position (1:10)

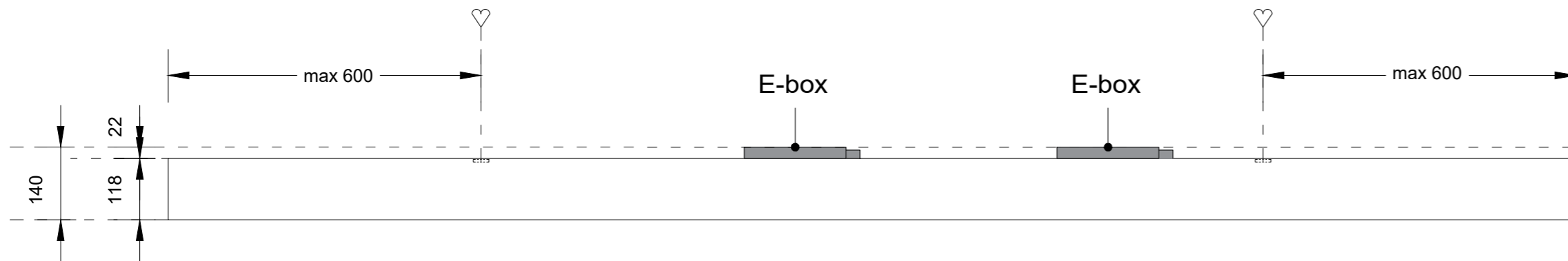

Section A-A (1:10)

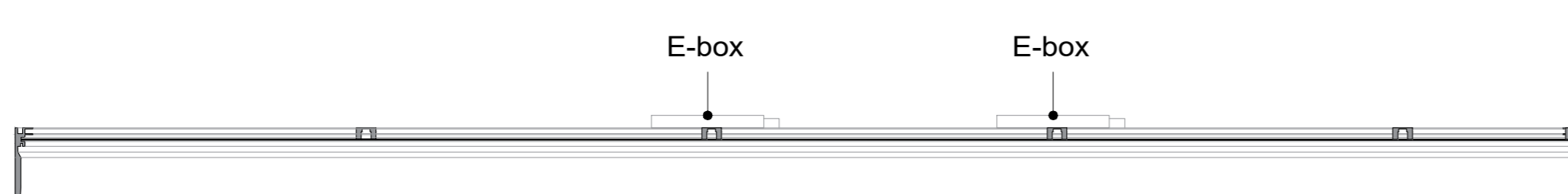

Detail 1 (1:1)

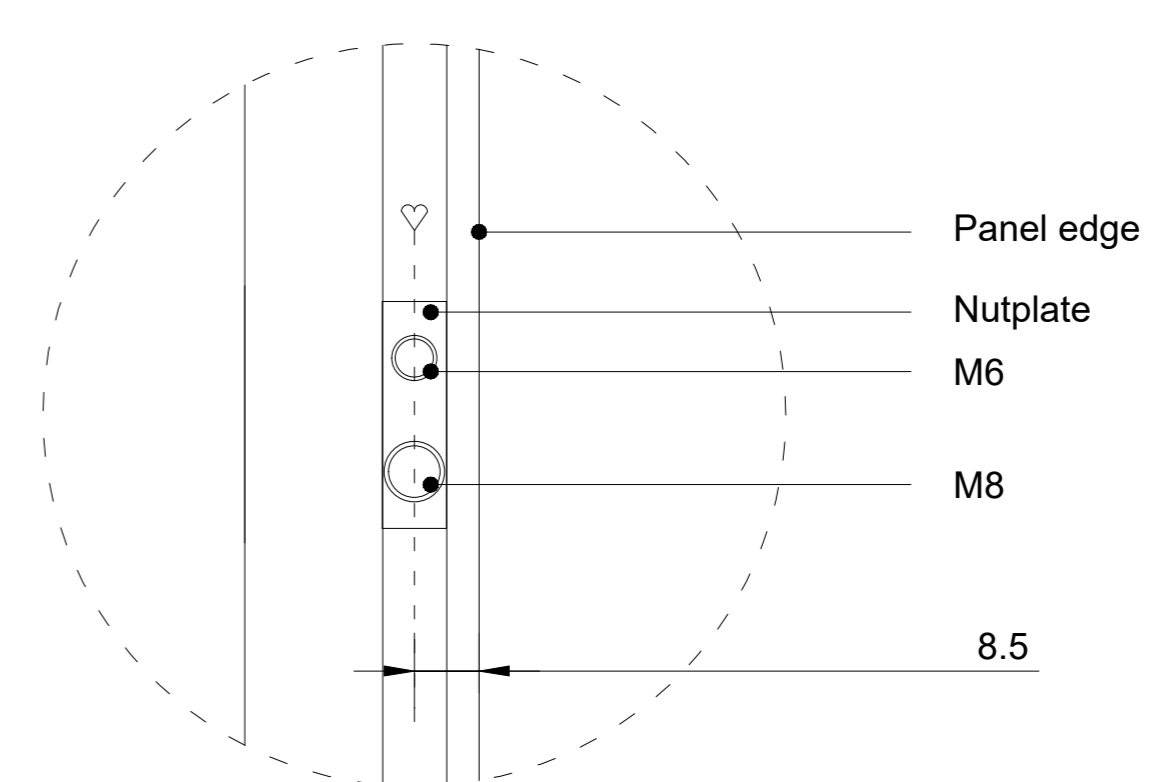

Backview (1:10)

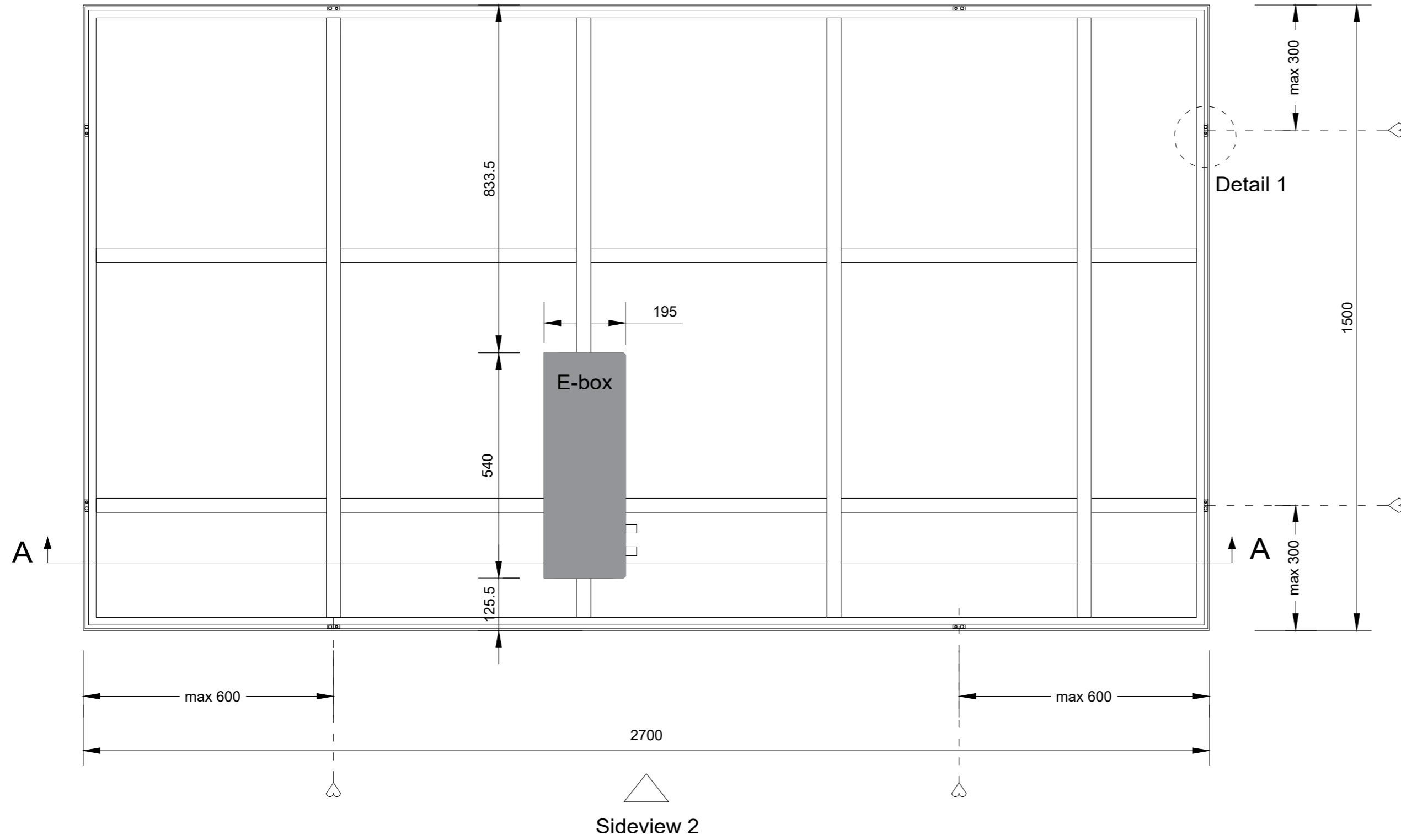

Sideview 1 - mounting position (1:10)

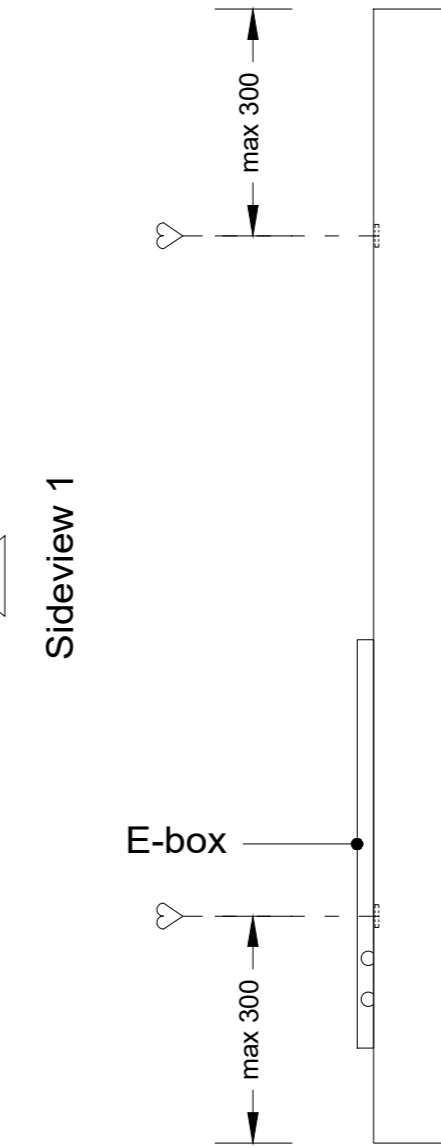

Sideview 2 - mounting position (1:10)

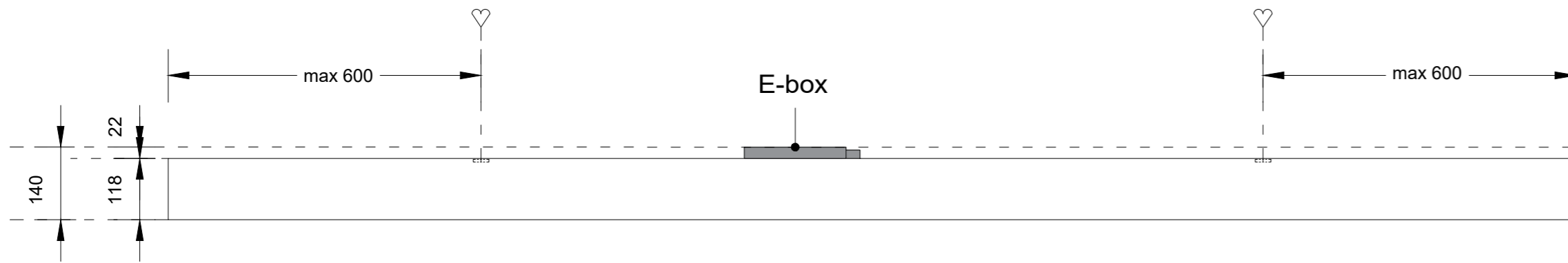

Section A-A (1:10)

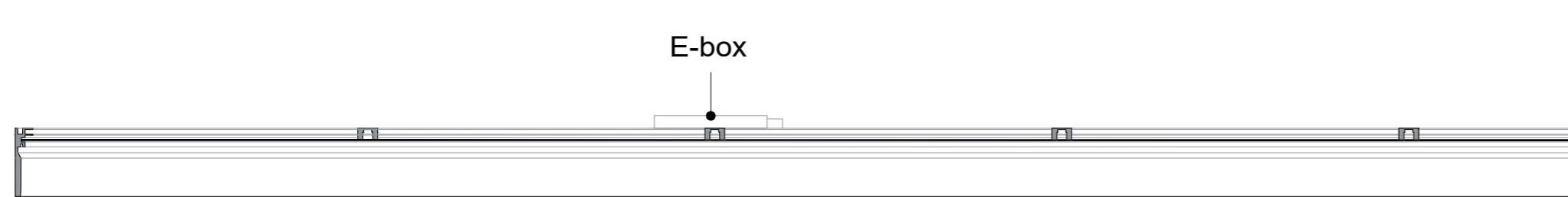

Detail 1 (1:1)

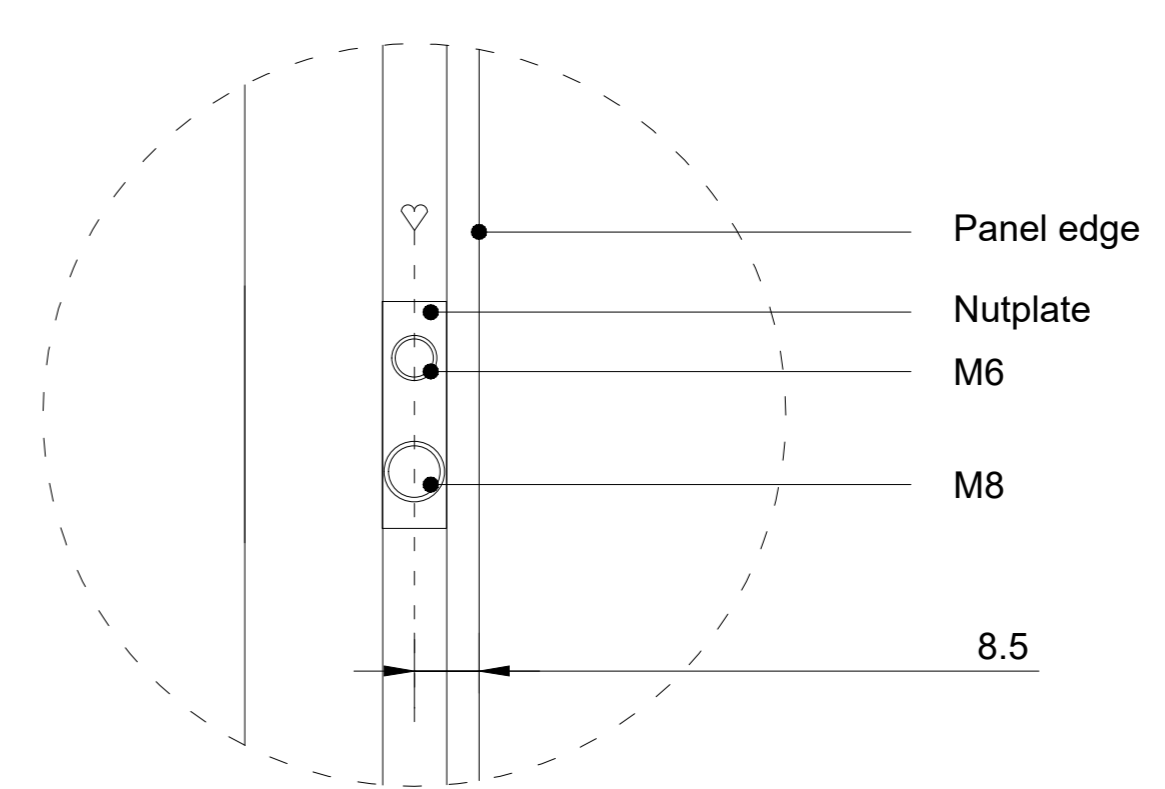

Backview (1:10)

Sideview 1 - mounting position (1:10)

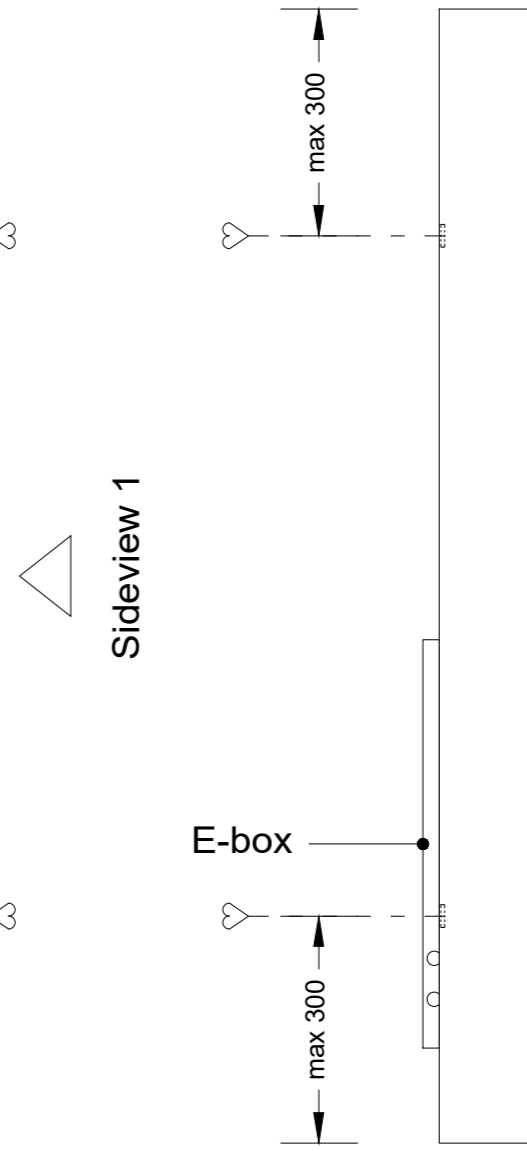
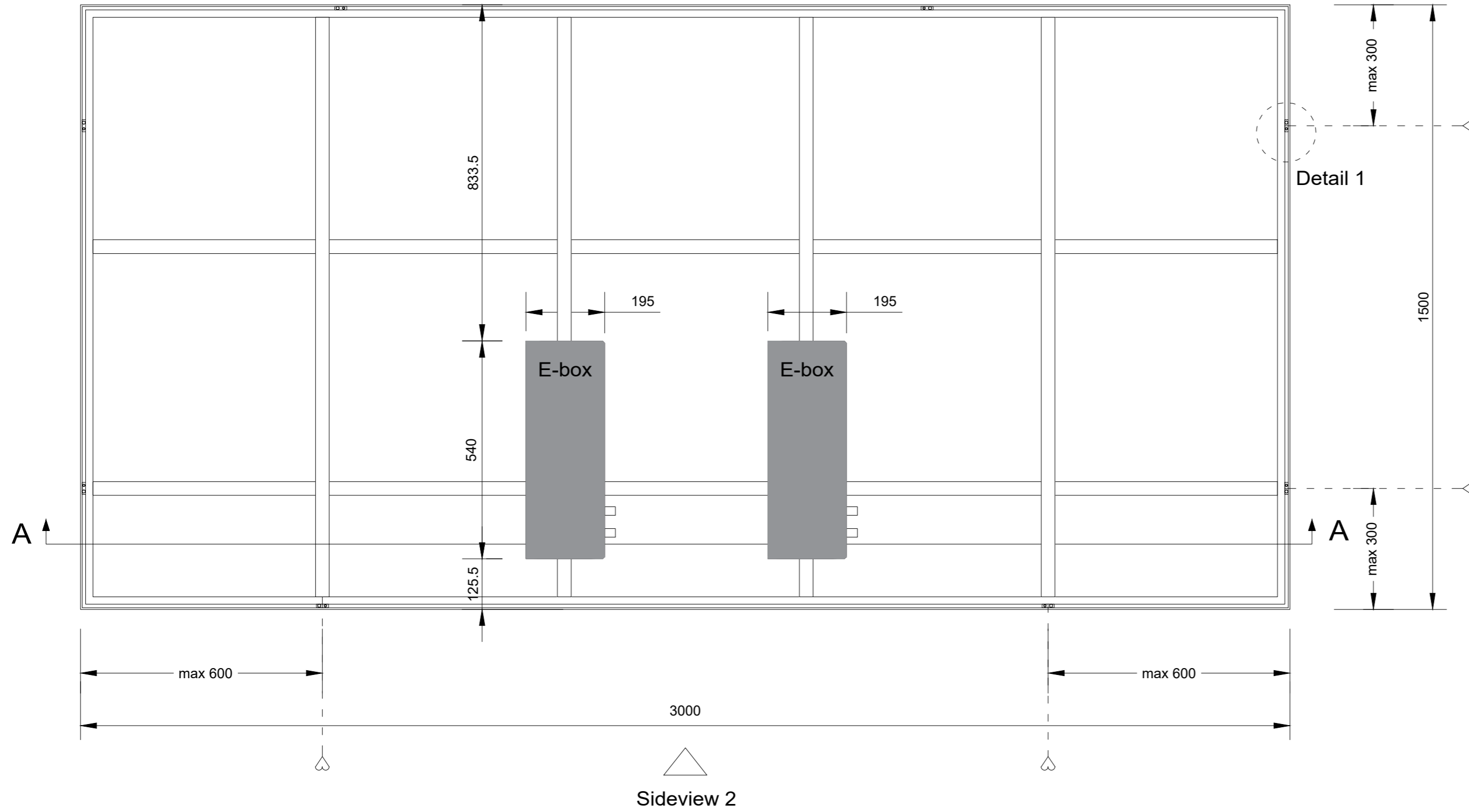

Sideview 2 - mounting position (1:10)

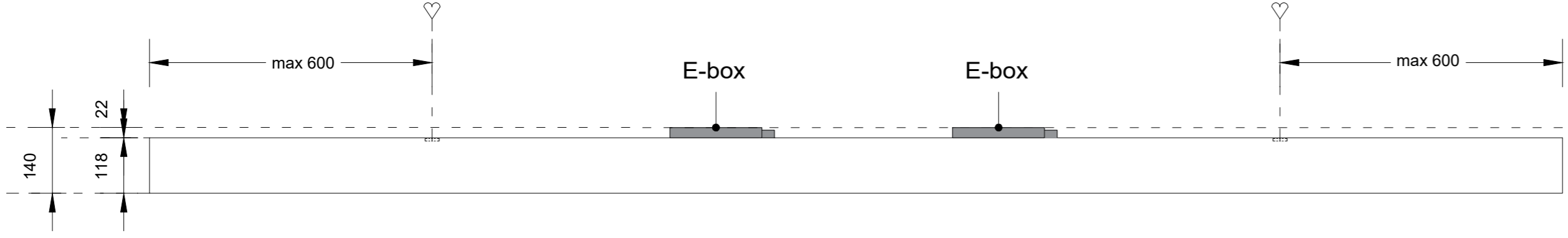

Section A-A (1:10)

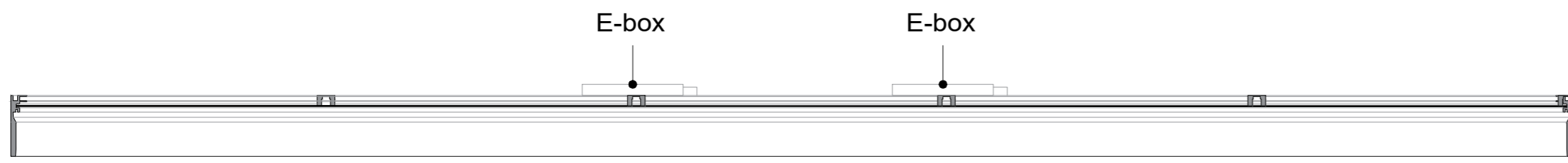

Detail 1 (1:1)

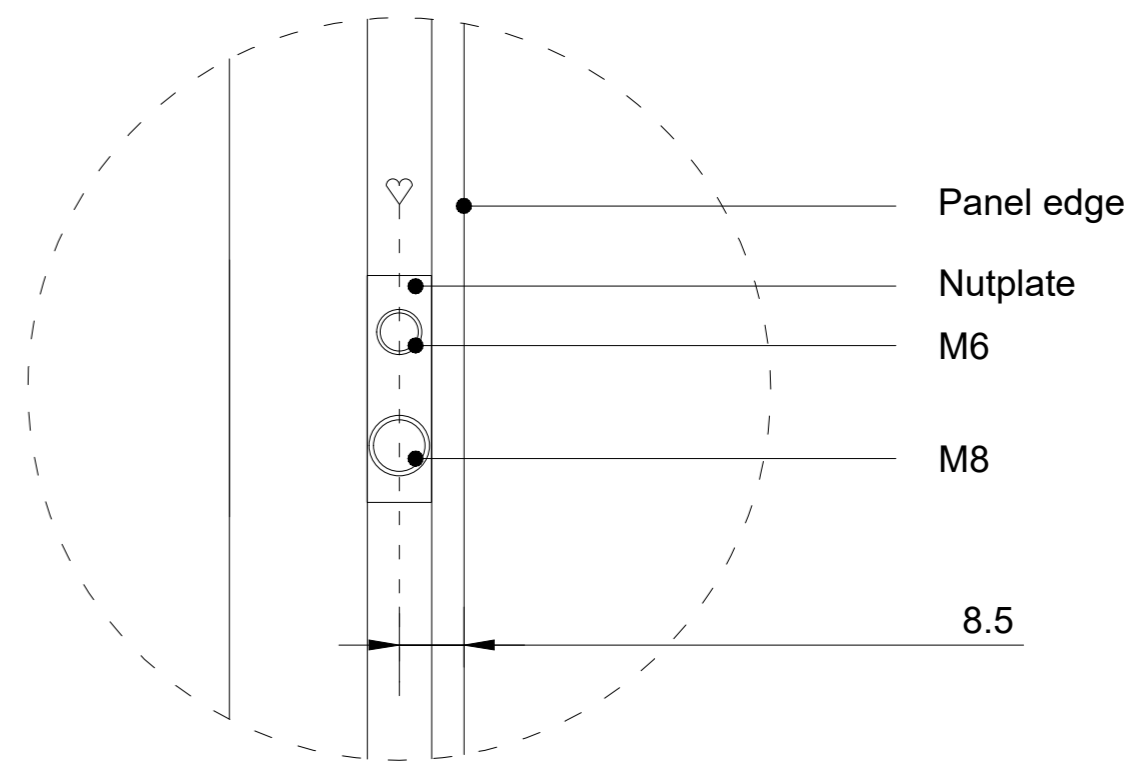

Backview (1:10)

Sideview 1 - mounting position (1:10)

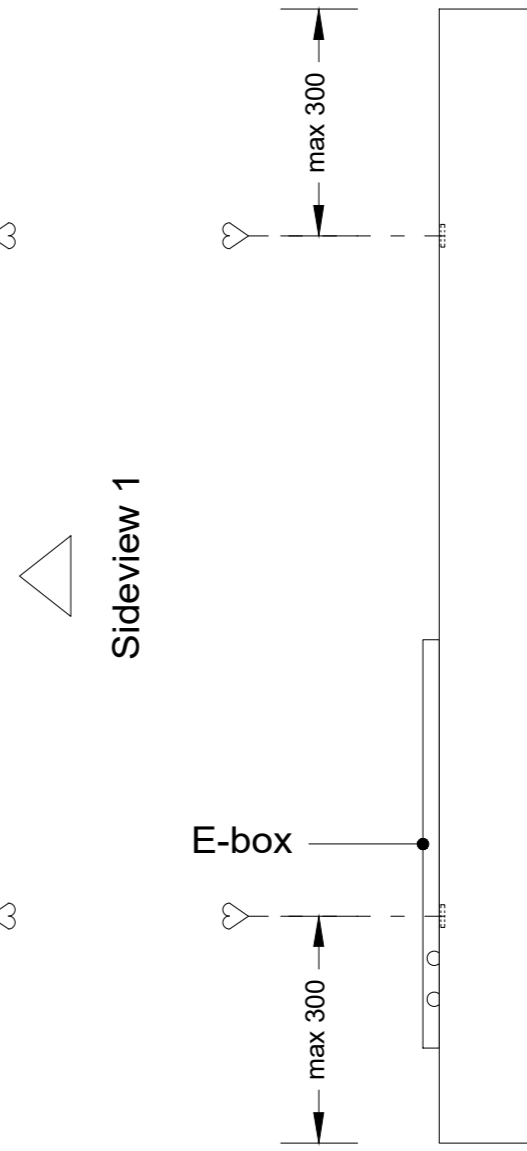
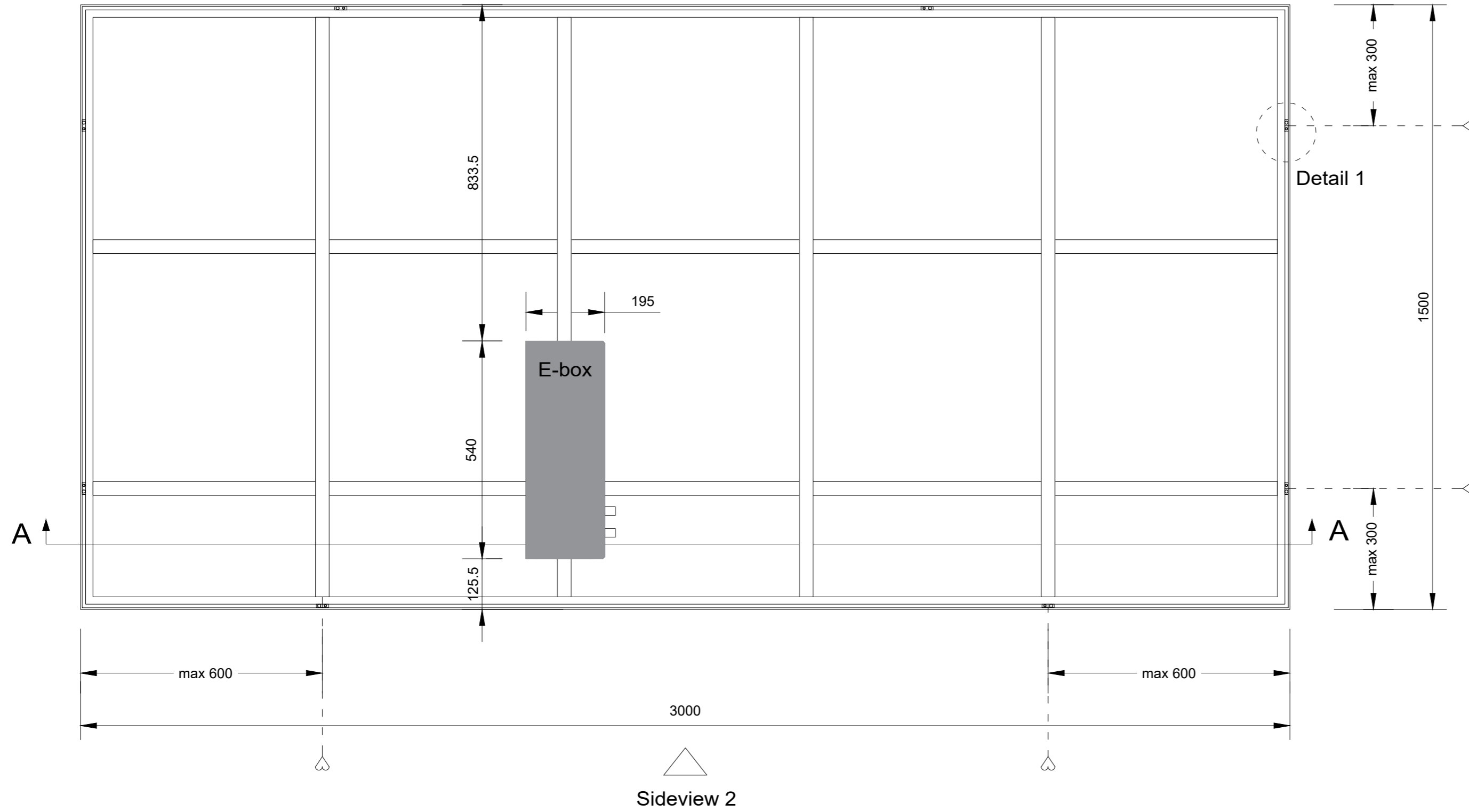

Sideview 2 - mounting position (1:10)

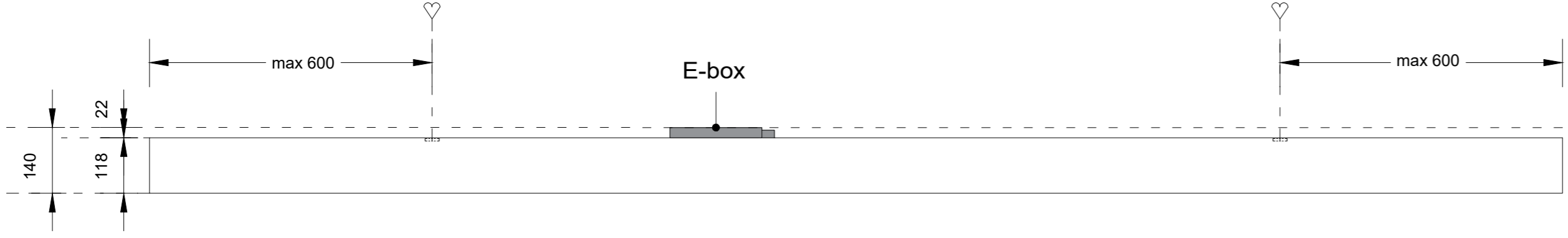

Section A-A (1:10)

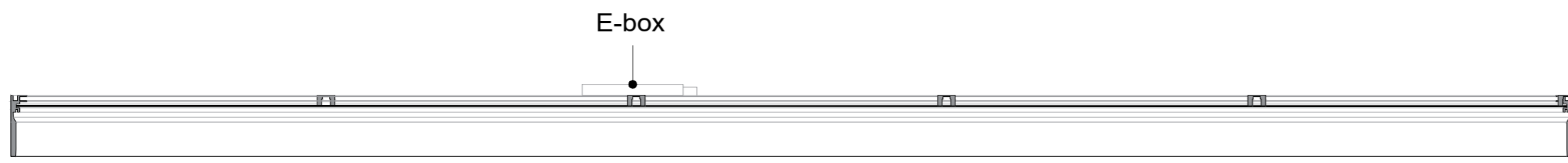

Detail 1 (1:1)

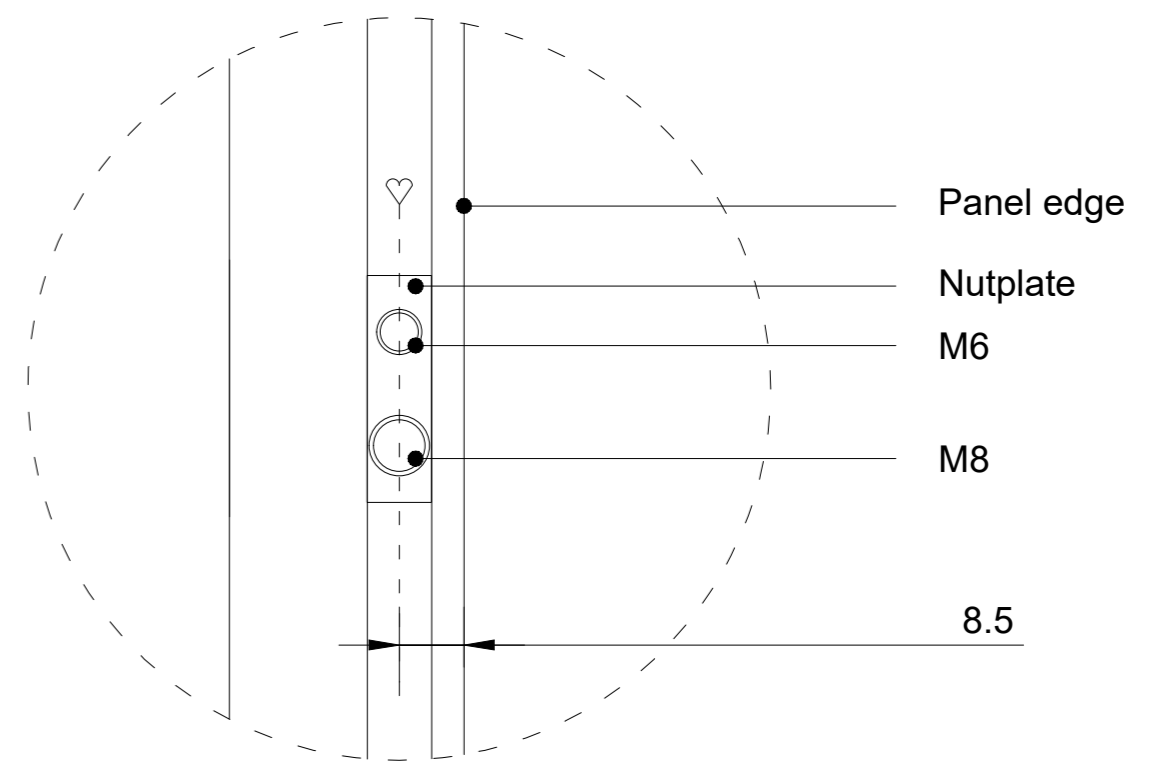

Backview (1:10)

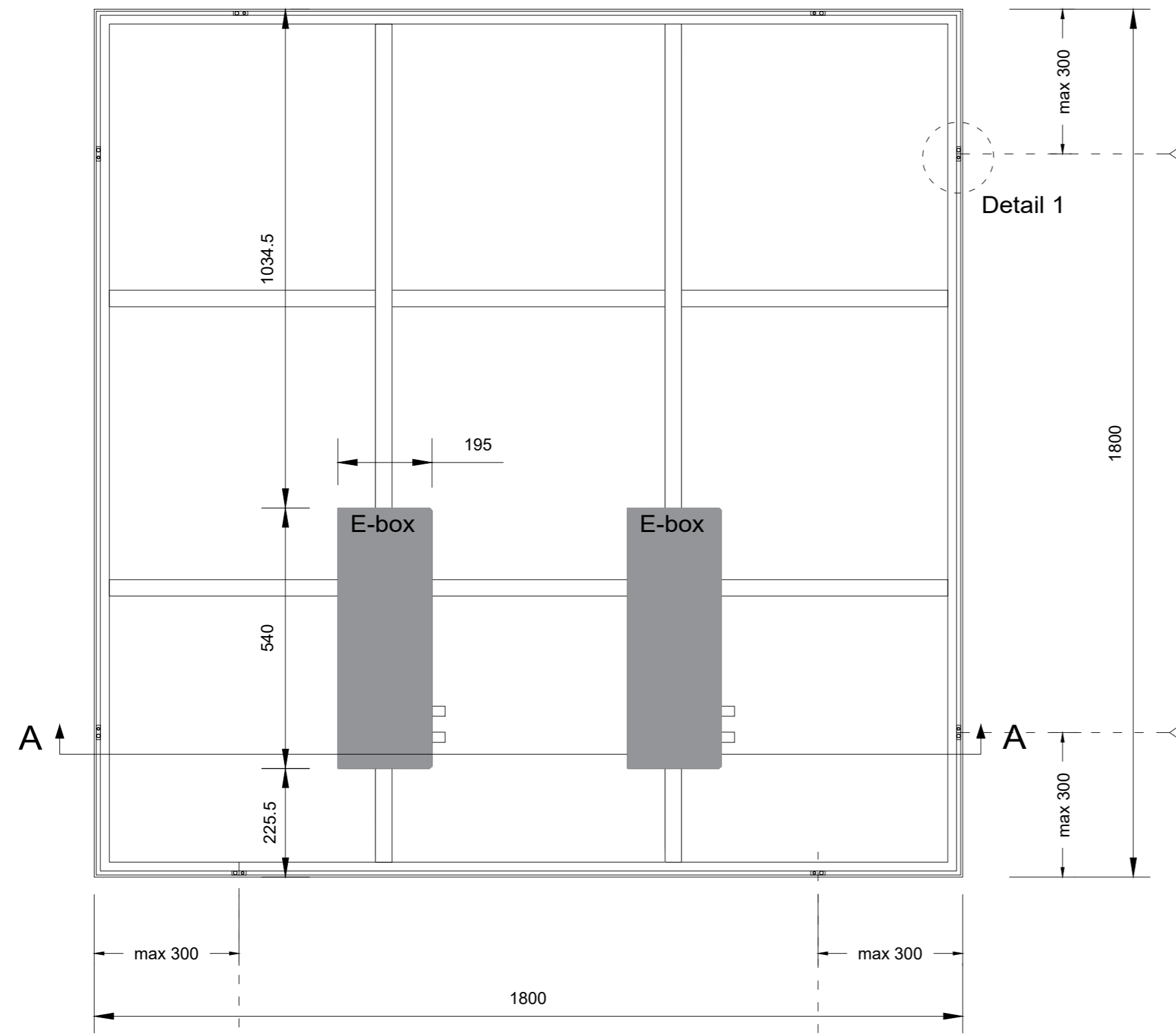

Sideview 1 - mounting position (1:10)

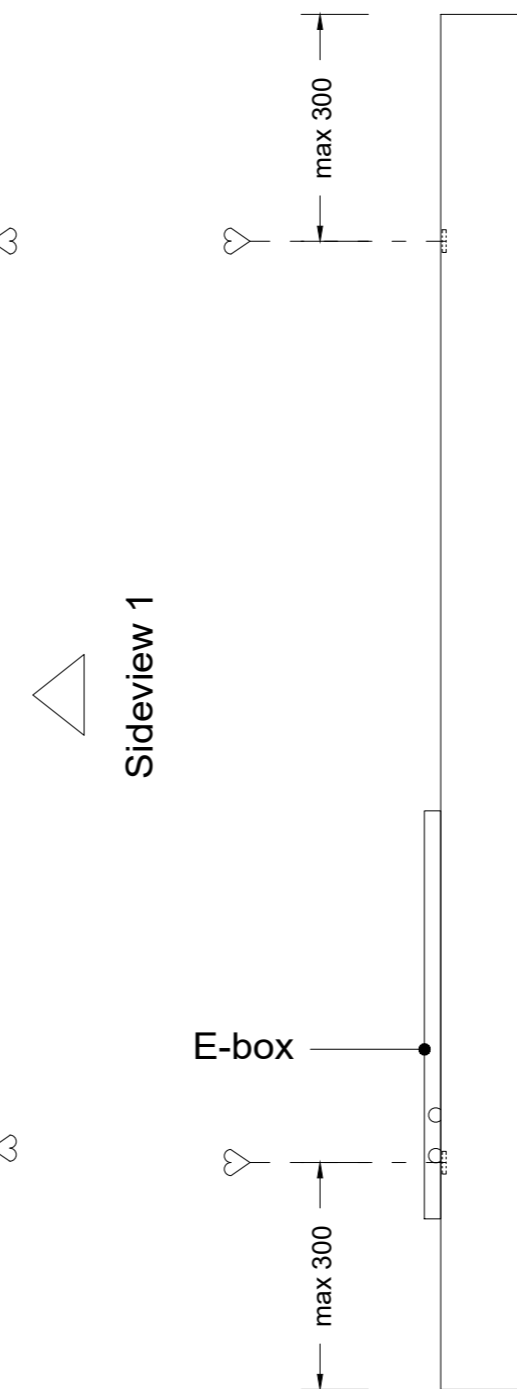

Sideview 2 - mounting position (1:10)

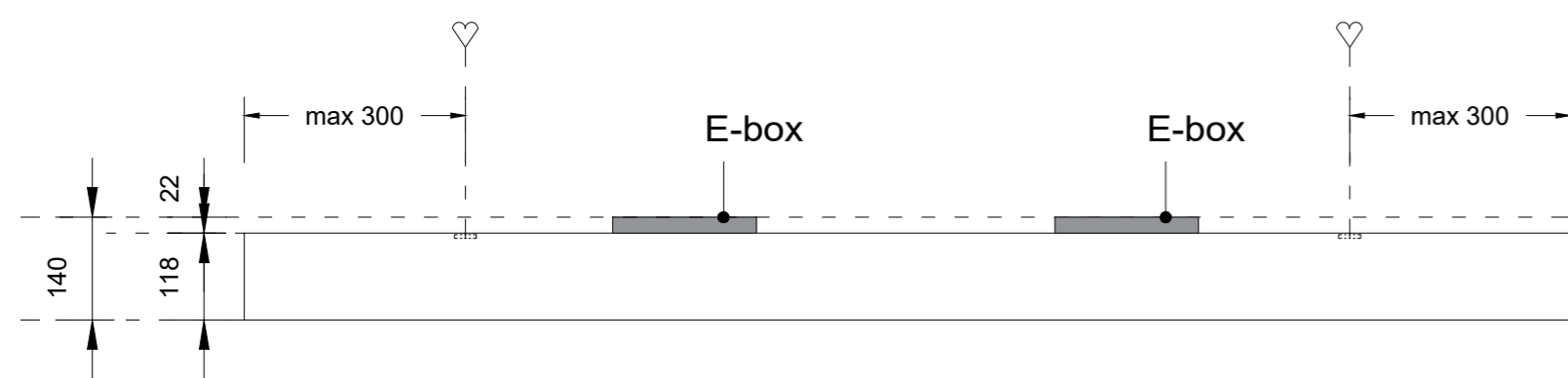

Section A-A (1:10)

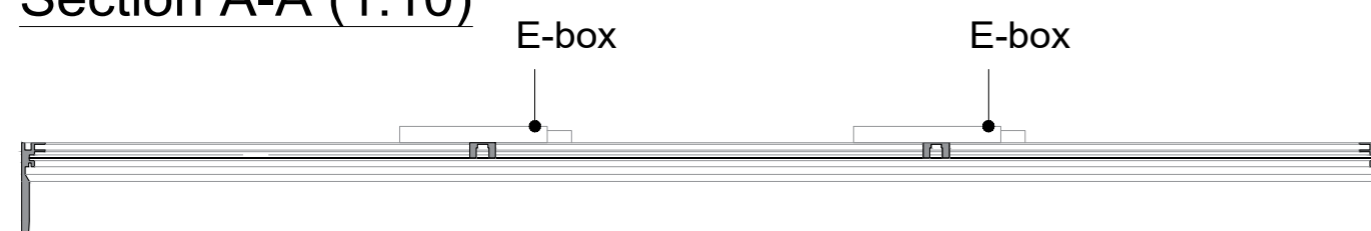

Detail 1 (1:1)

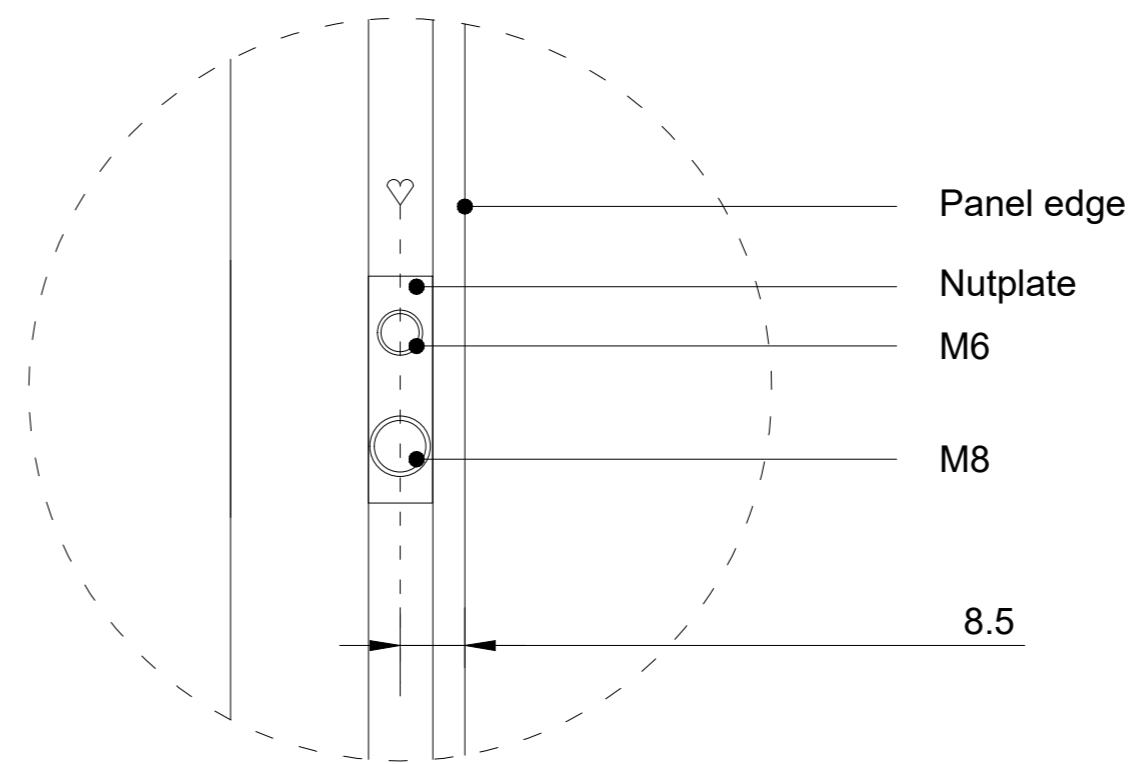

Backview (1:10)

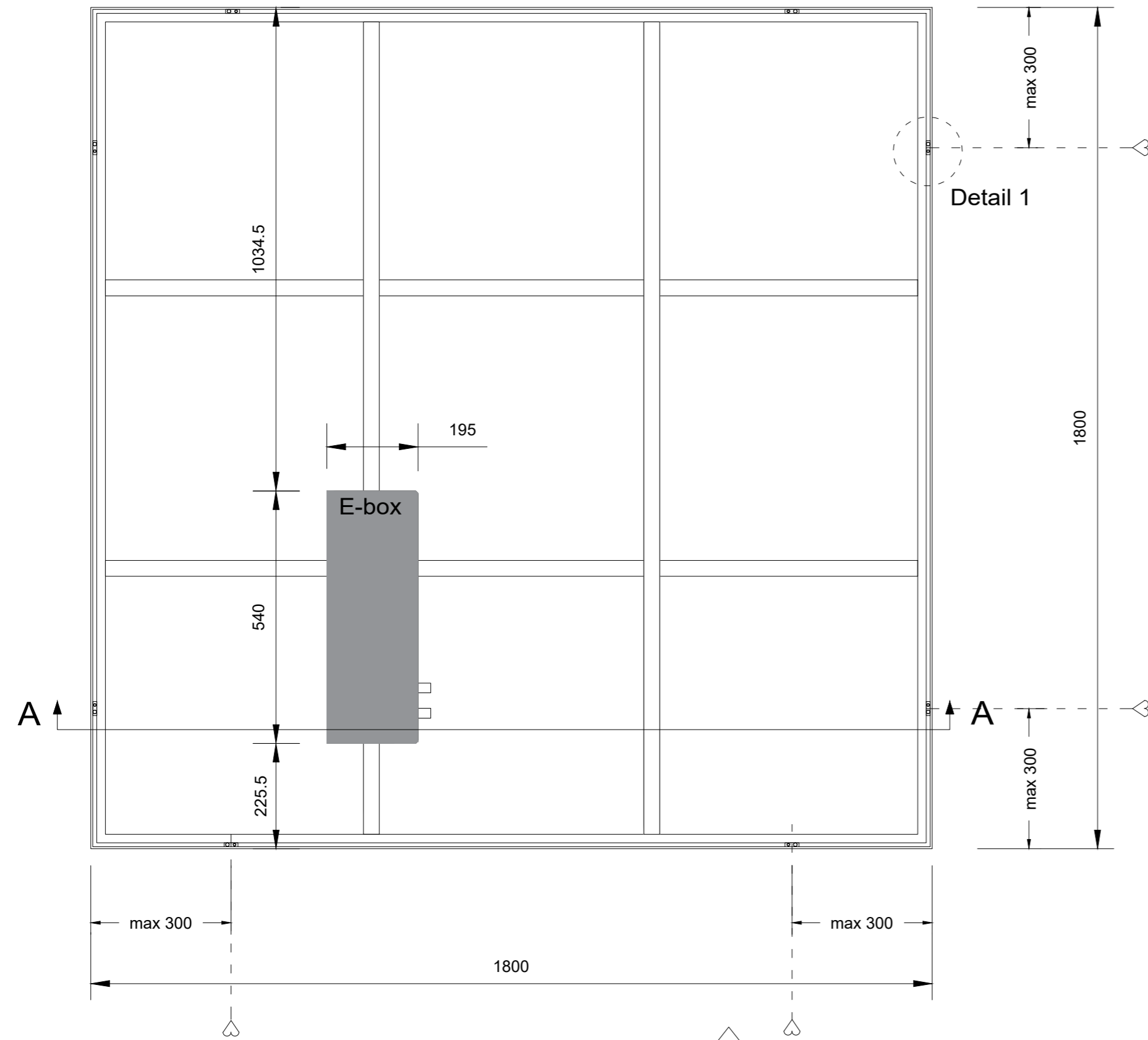

Sideview 1 - mounting position (1:10)

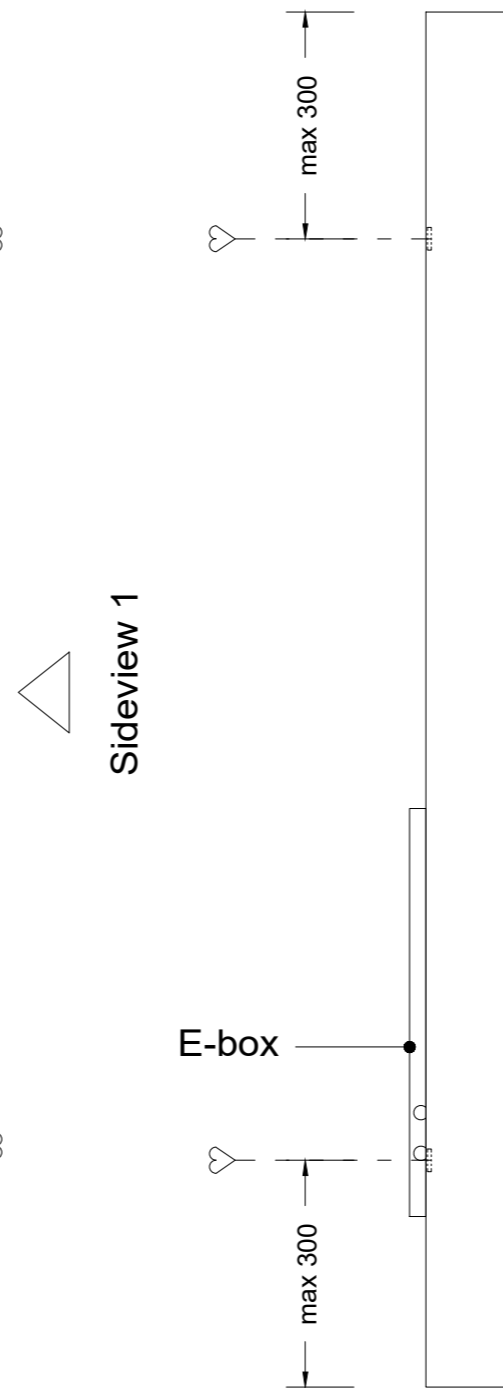

Sideview 2 - mounting position (1:10)

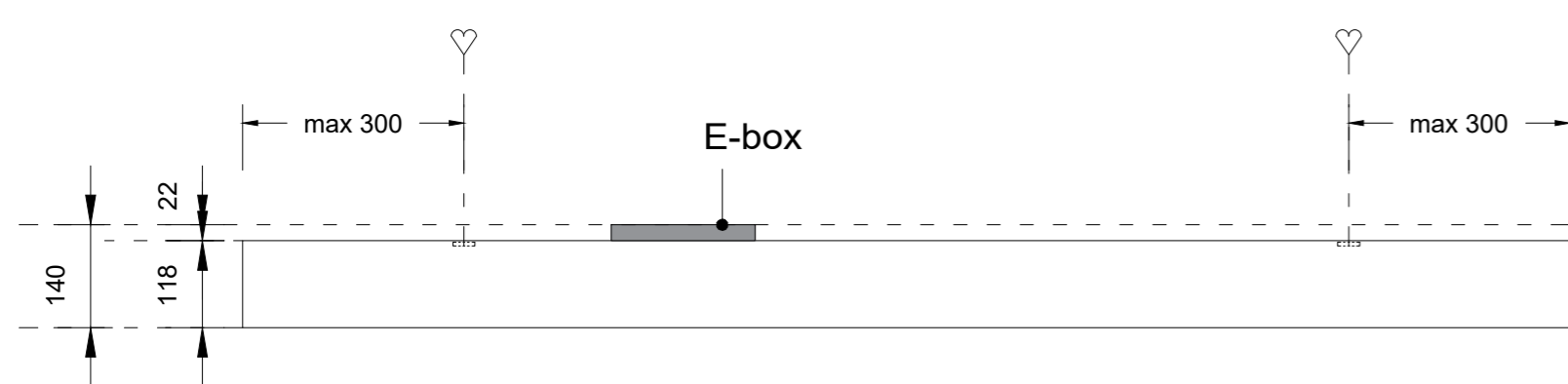

Section A-A (1:10)

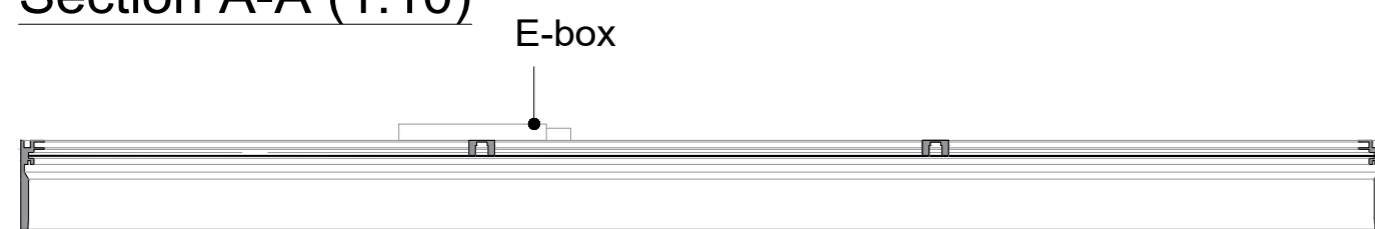

Detail 1 (1:1)

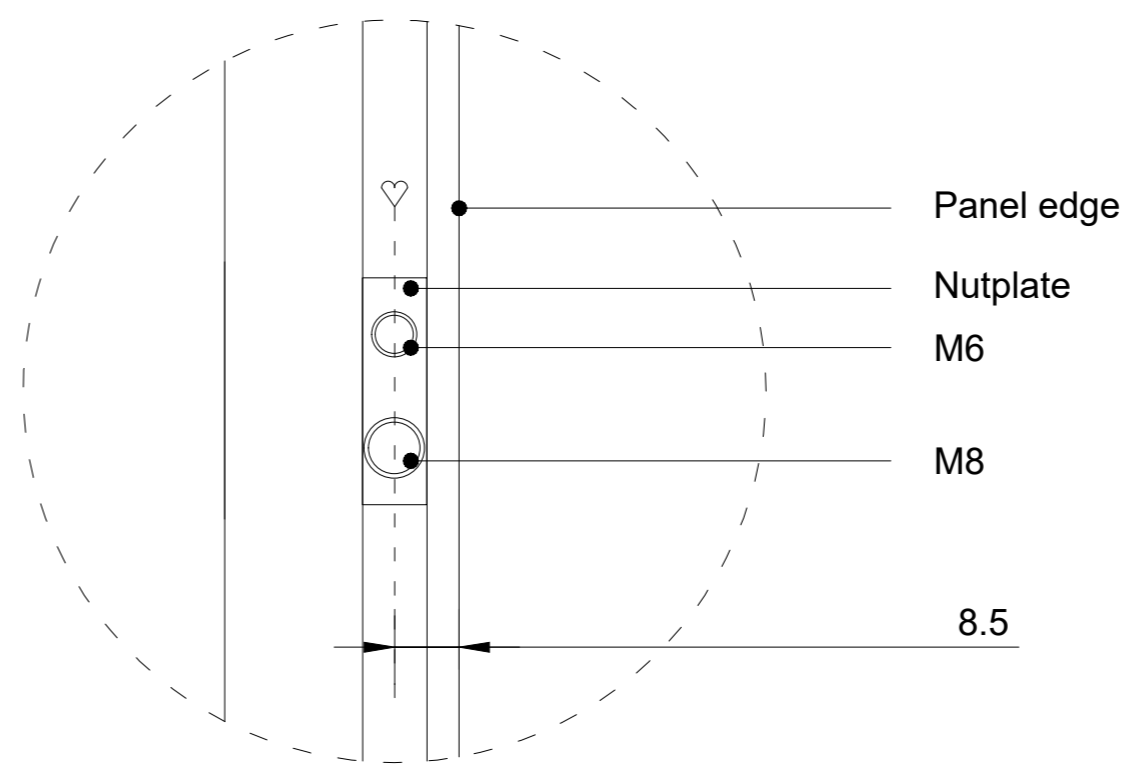

Backview (1:10)

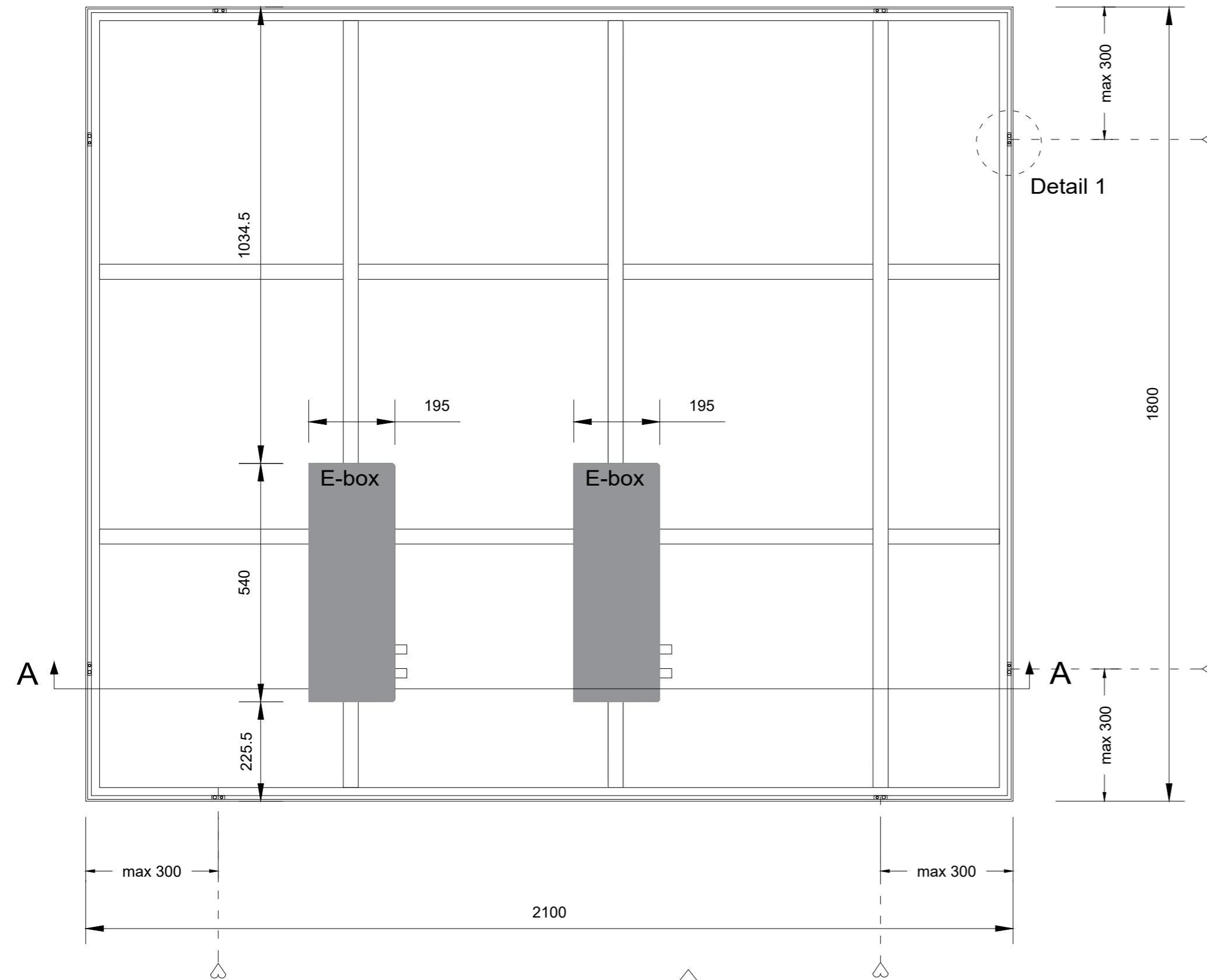

Sideview 1 - mounting position (1:10)

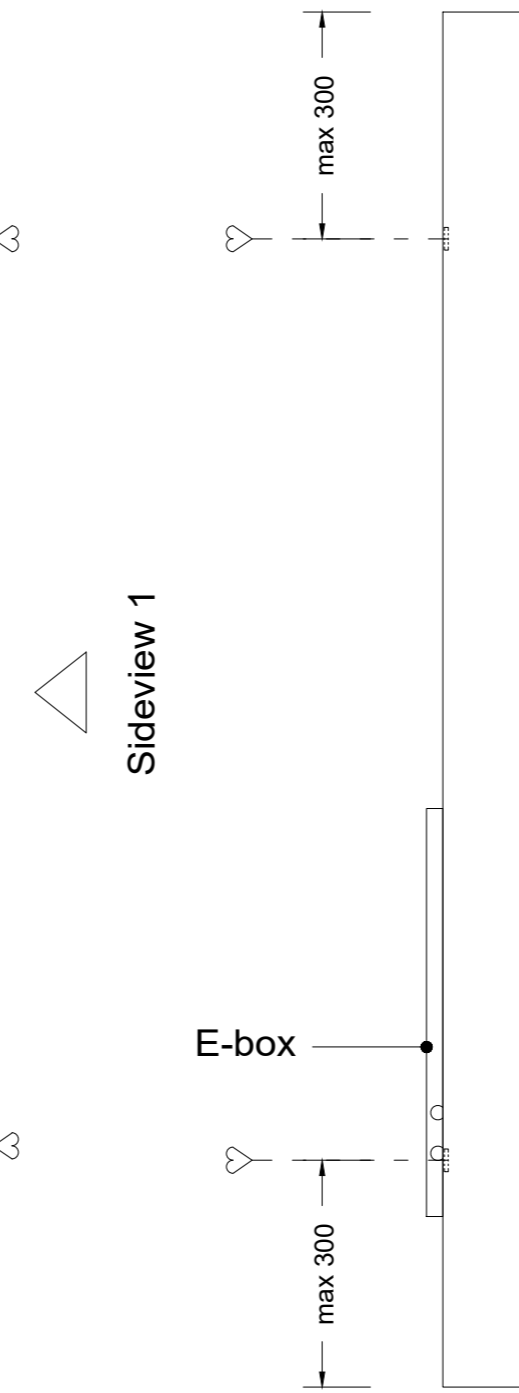

Sideview 2 - mounting position (1:10)

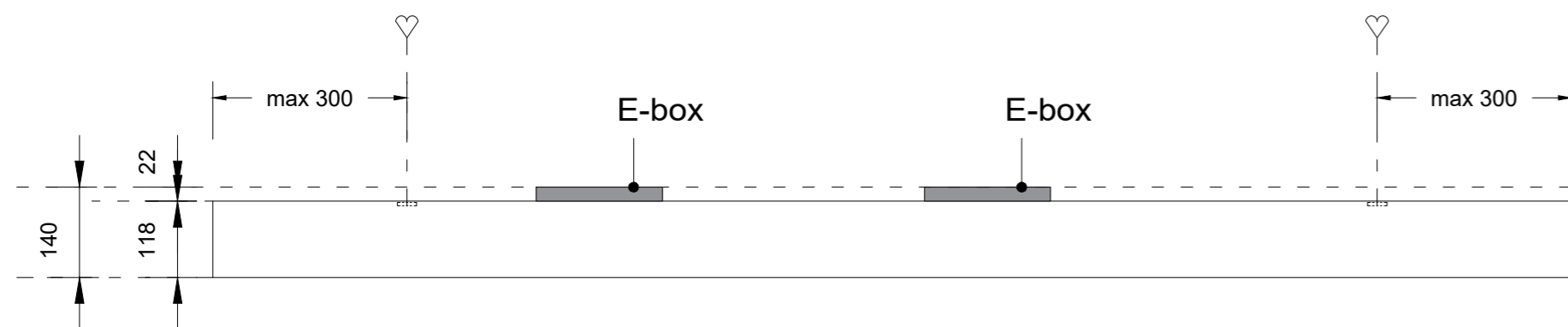

Section A-A (1:10)

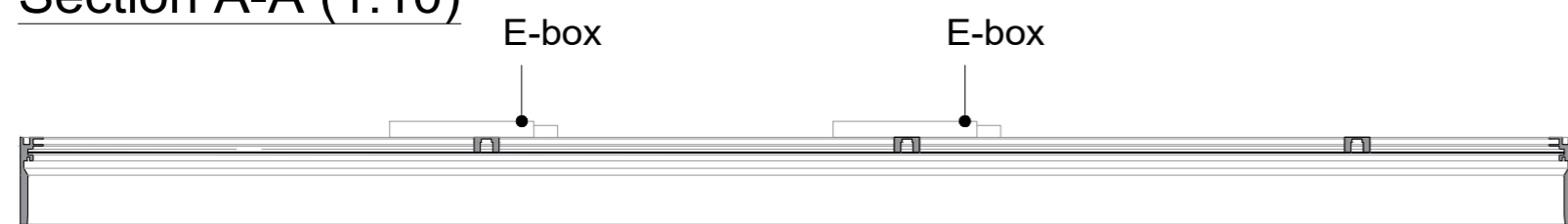

Detail 1 (1:1)

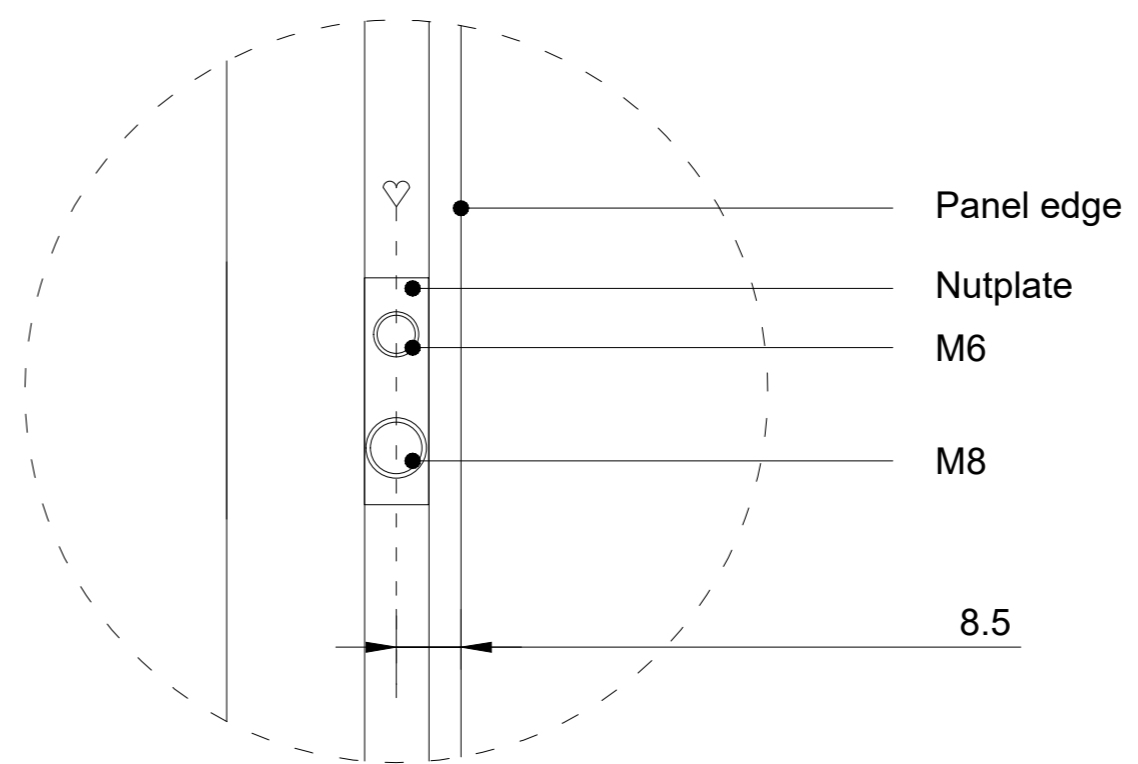

Backview (1:10)

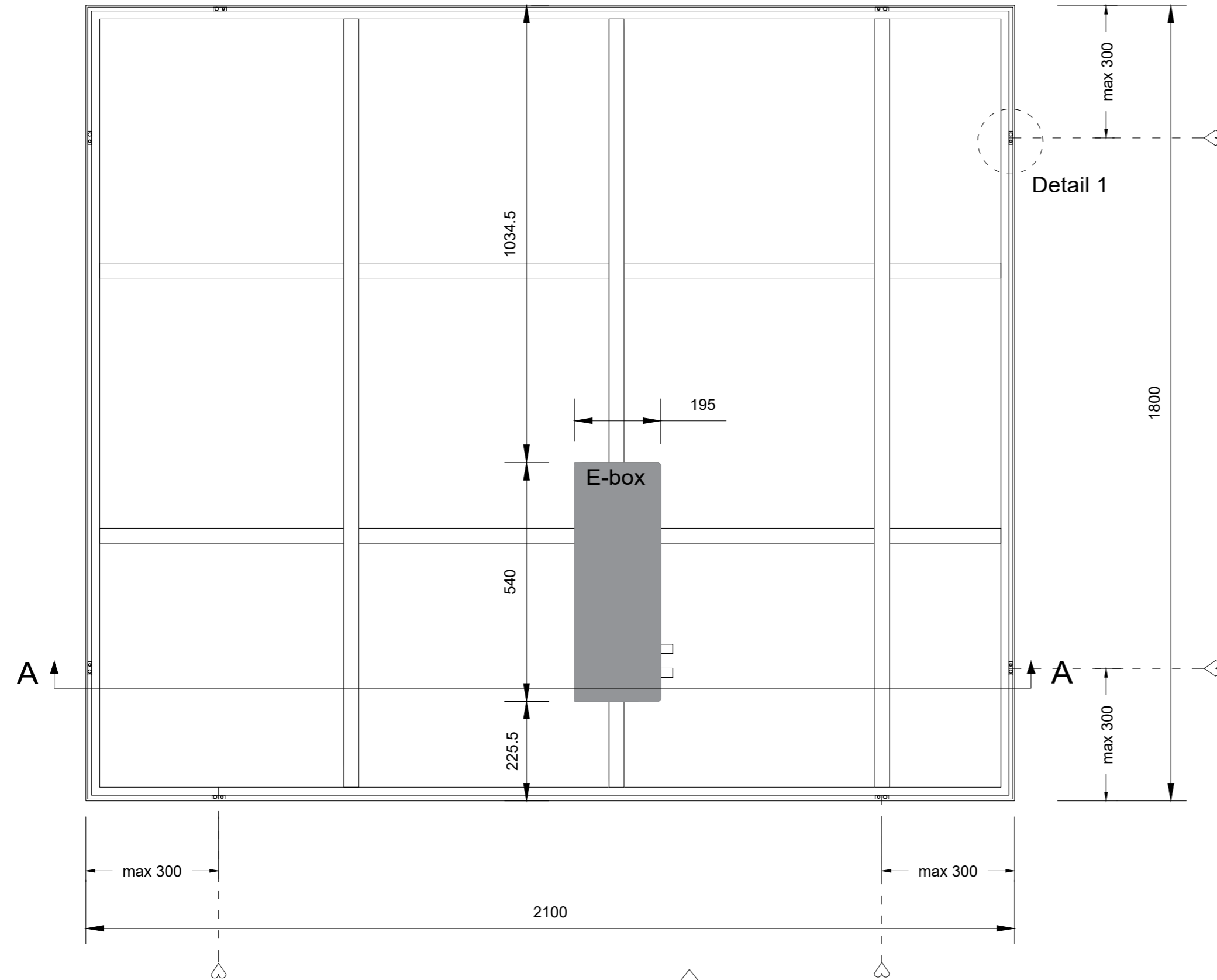

Sideview 1 - mounting position (1:10)

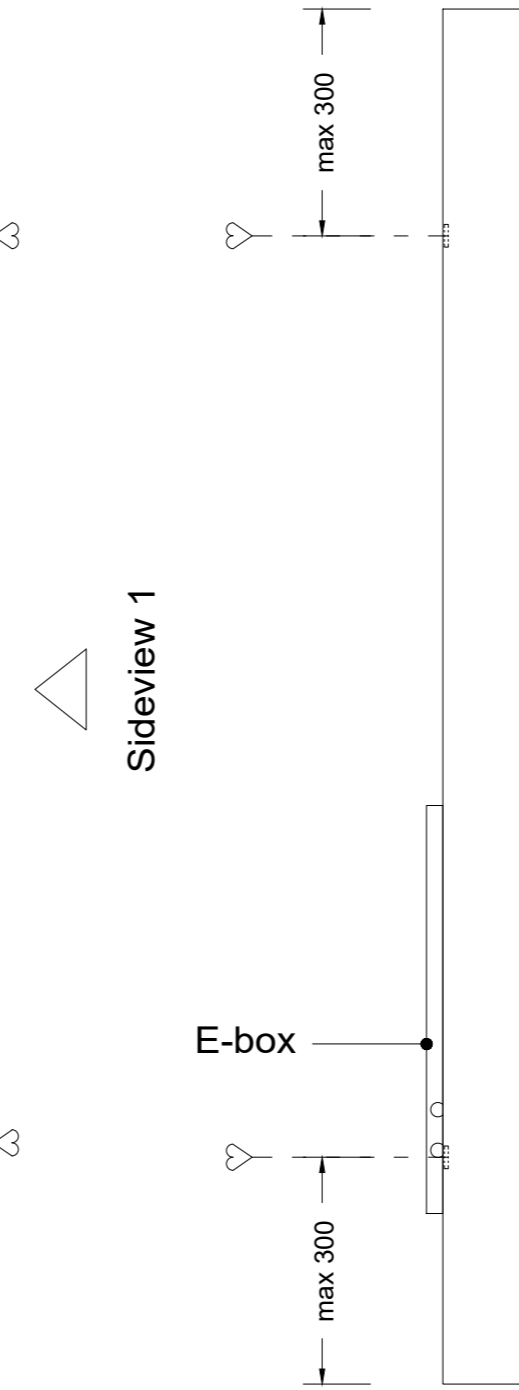

Sideview 2 - mounting position (1:10)

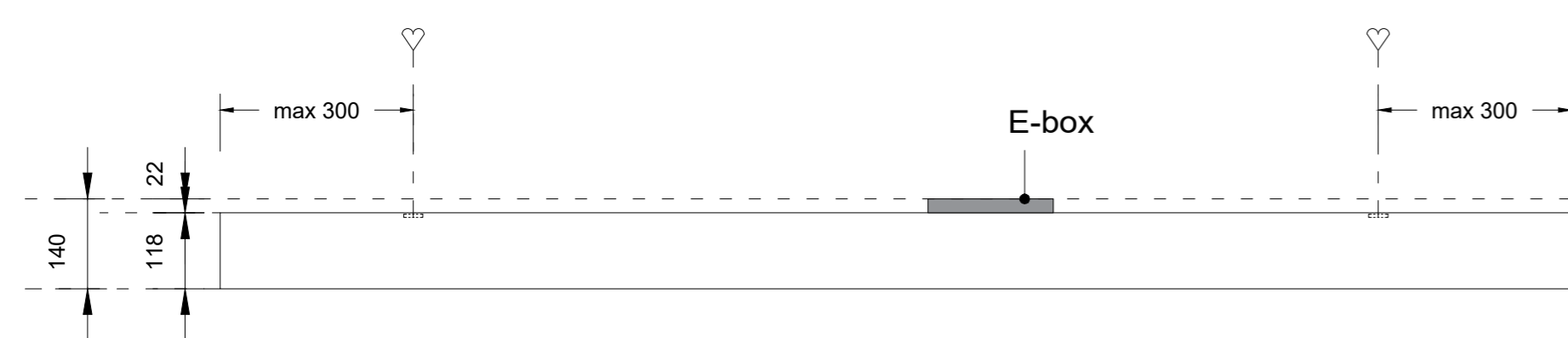

Section A-A (1:10)

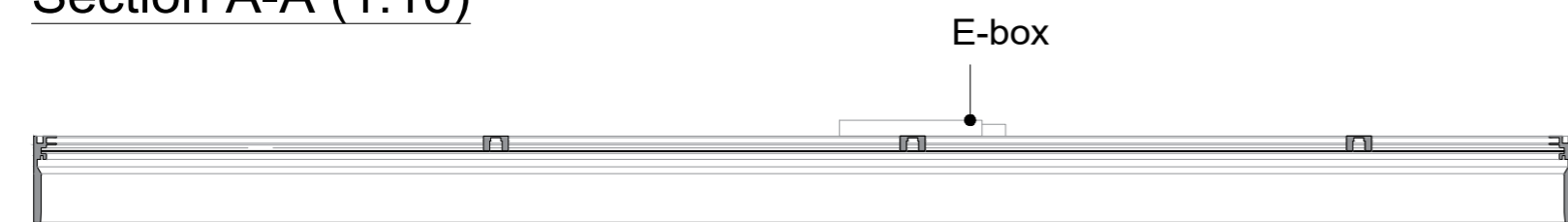

Detail 1 (1:1)

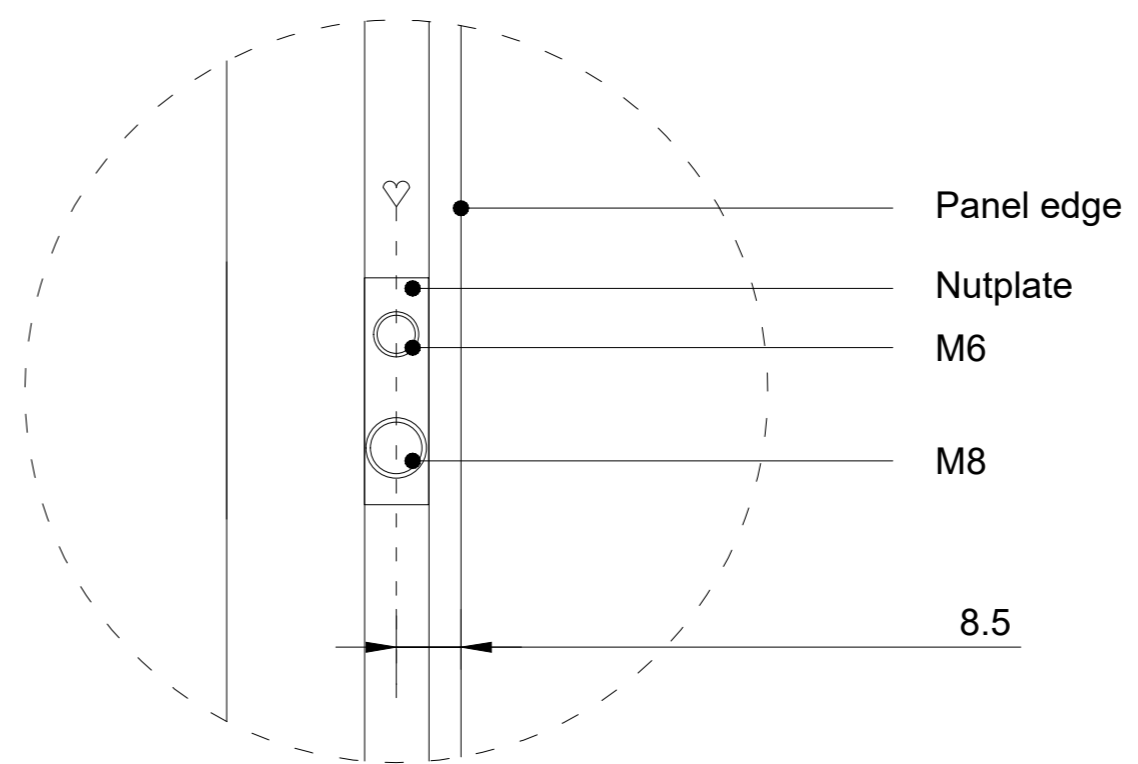



Backview (1:10)

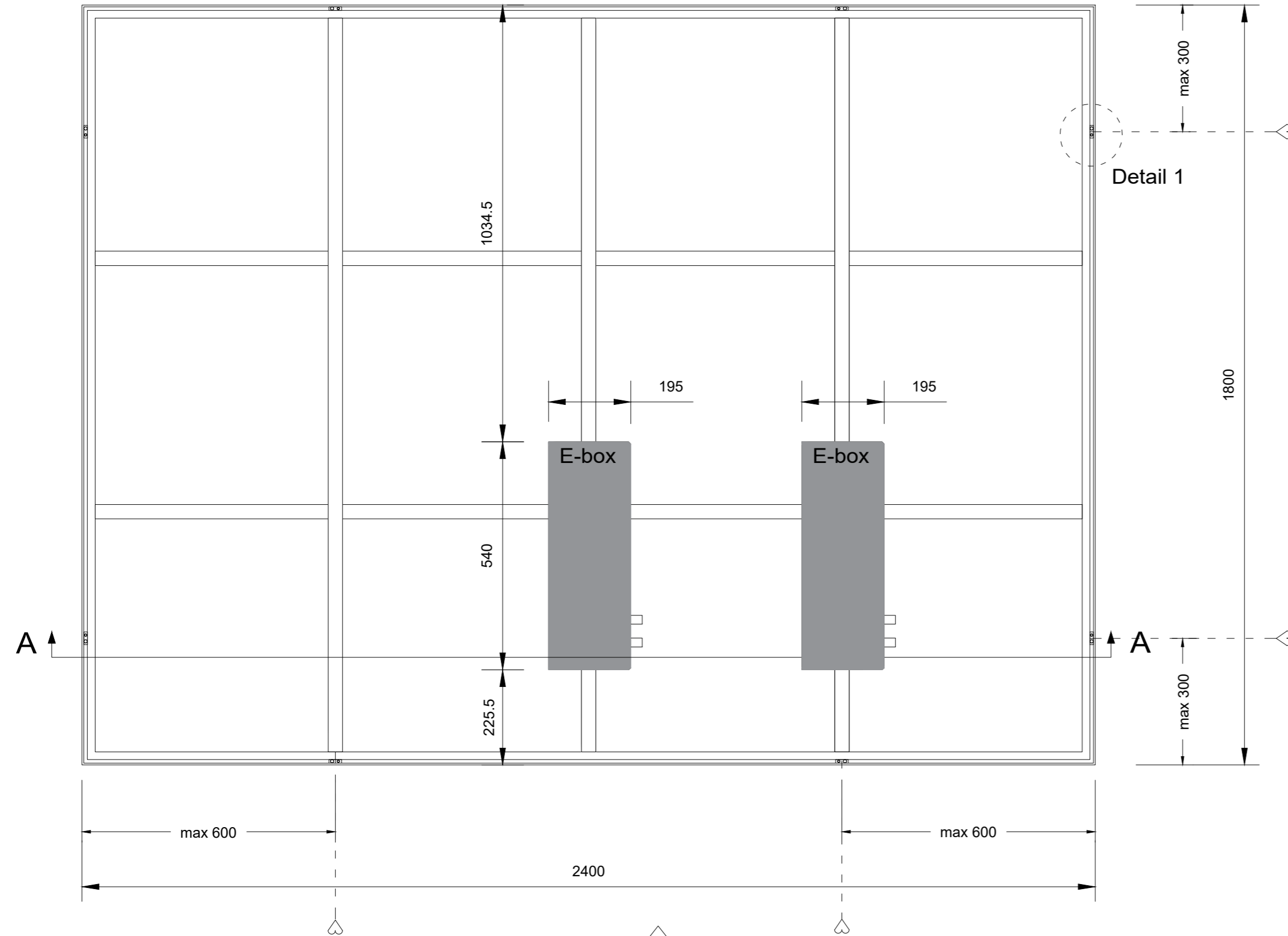

Sideview 1 - mounting position (1:10)

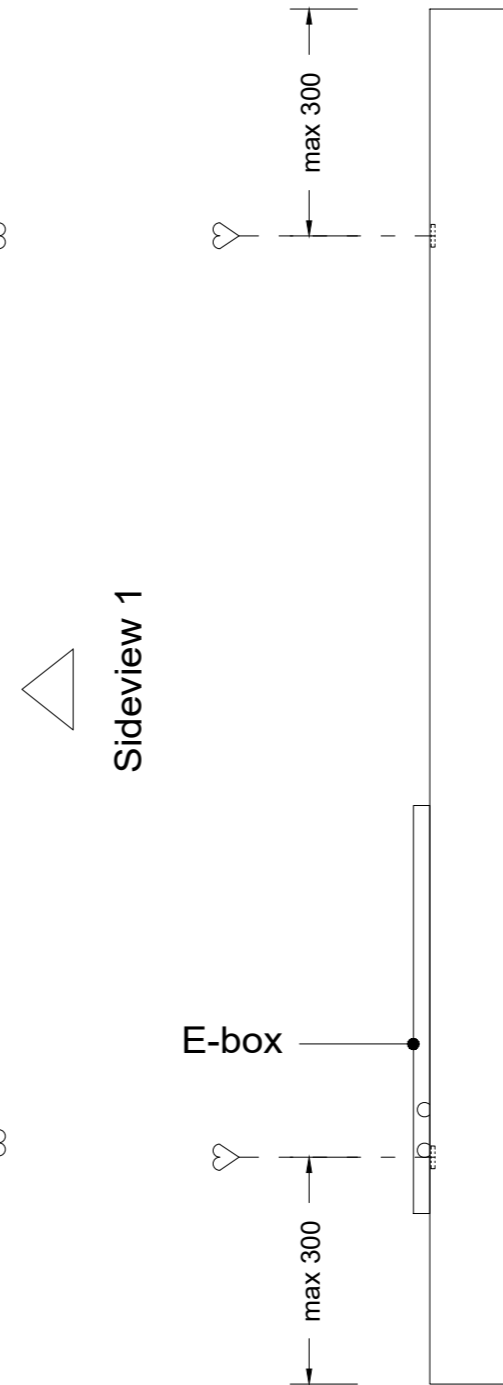

Sideview 2 - mounting position (1:10)

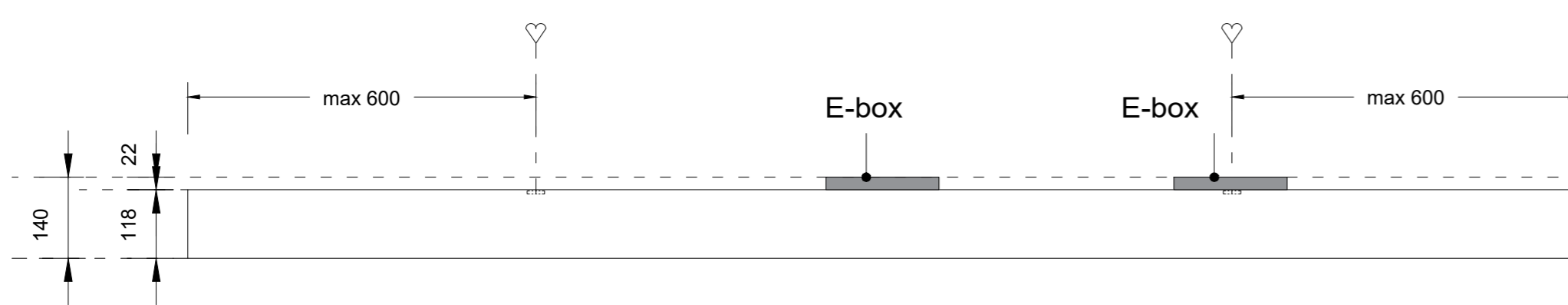

Section A-A (1:10)

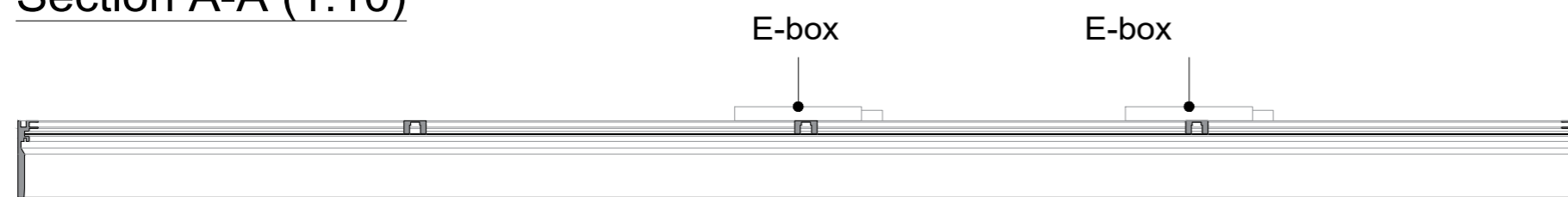

Detail 1 (1:1)

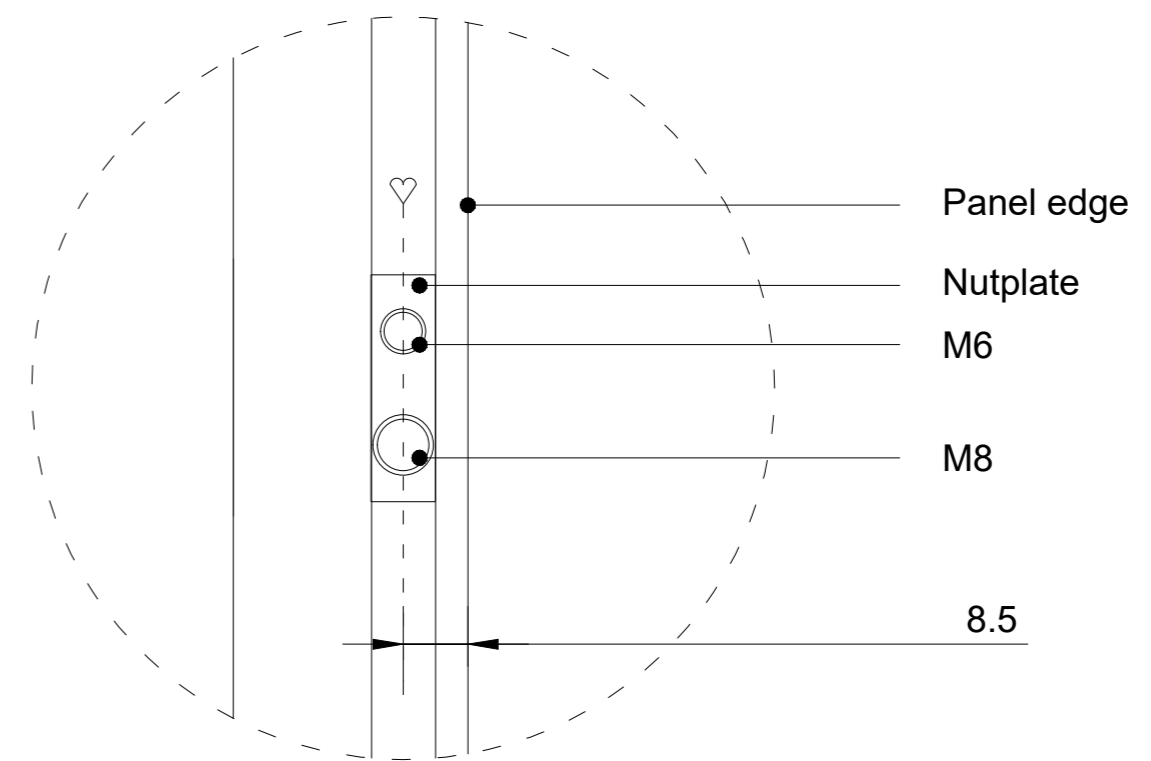

Backview (1:10)

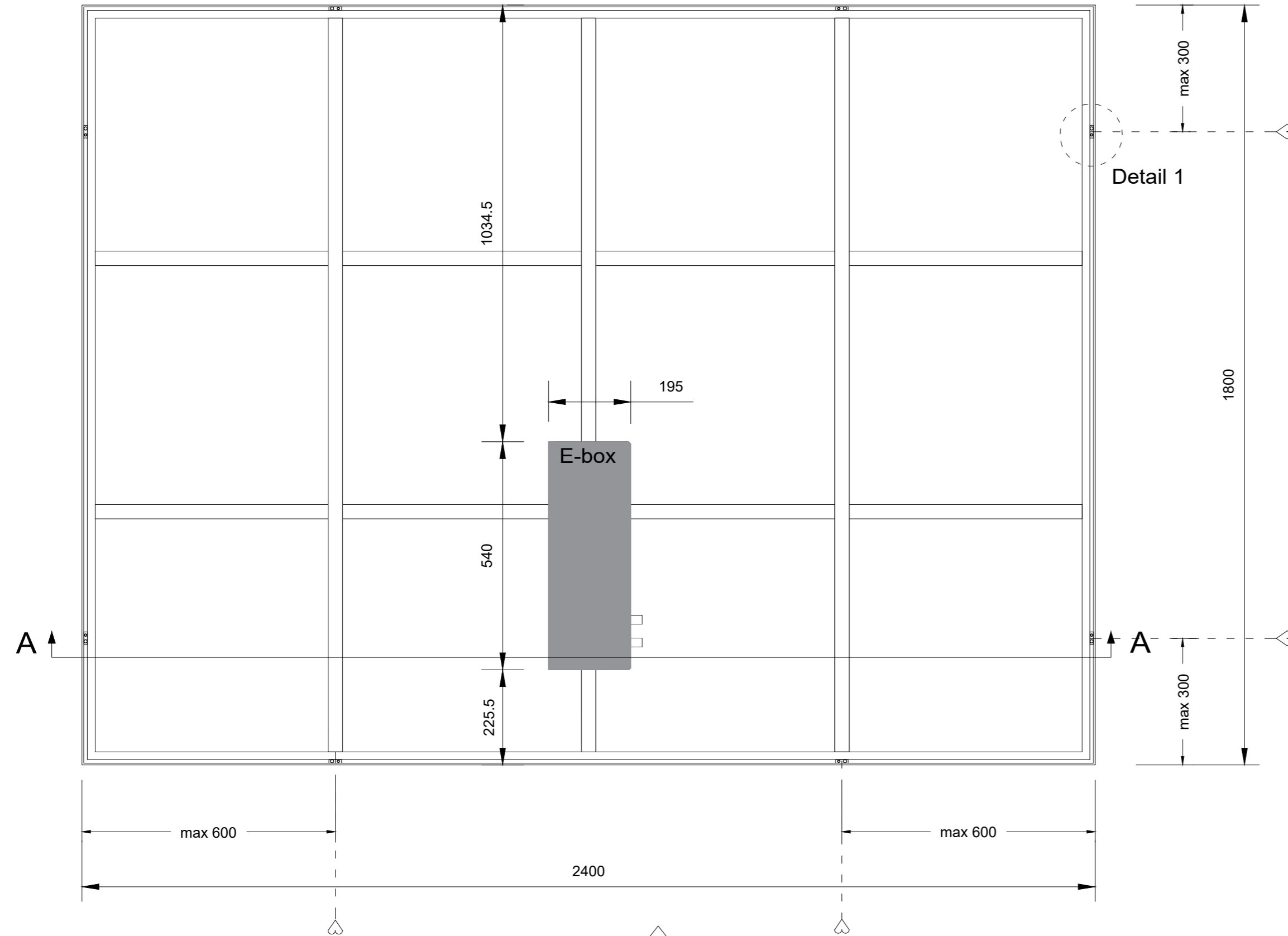

Sideview 1 - mounting position (1:10)

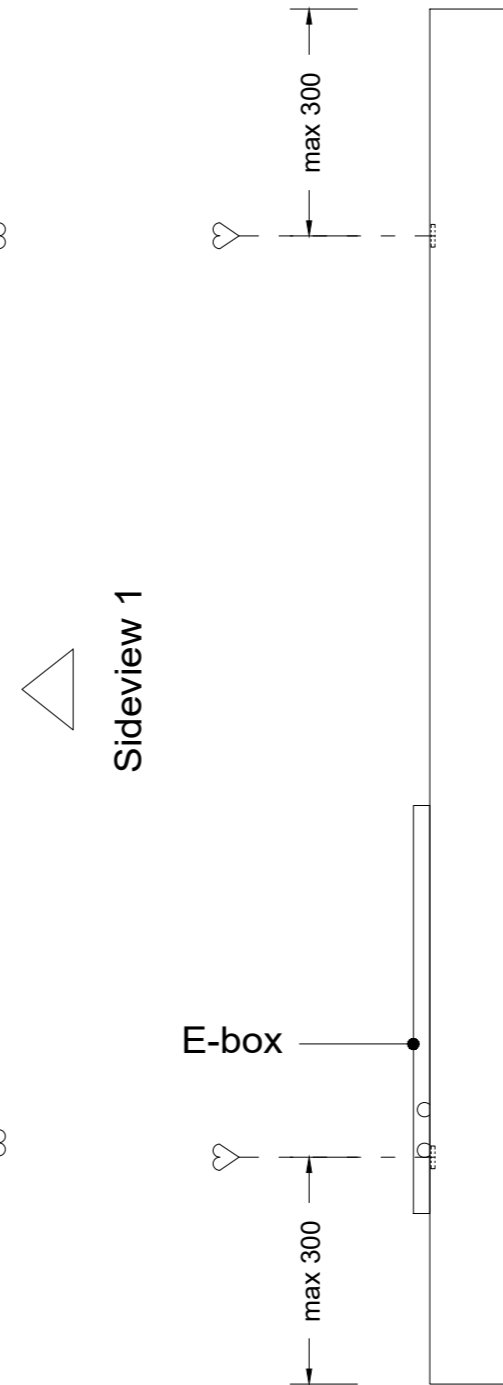

Sideview 2 - mounting position (1:10)

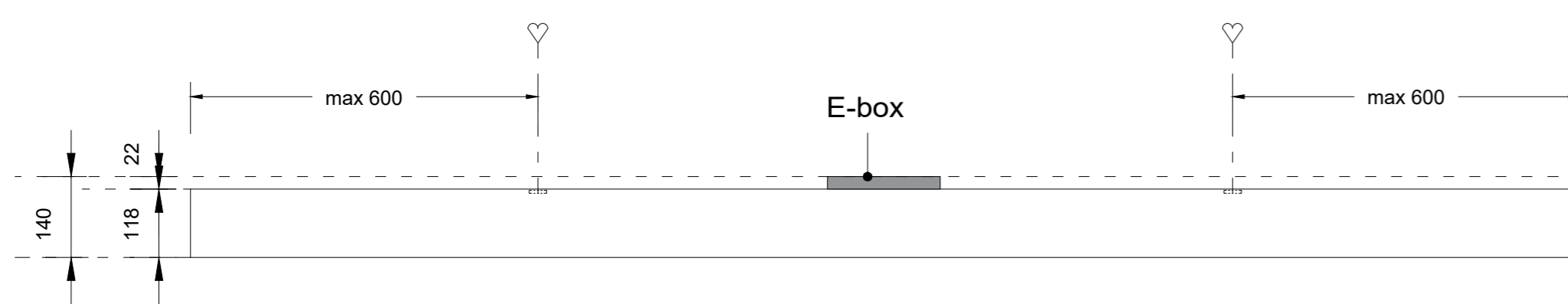

Section A-A (1:10)

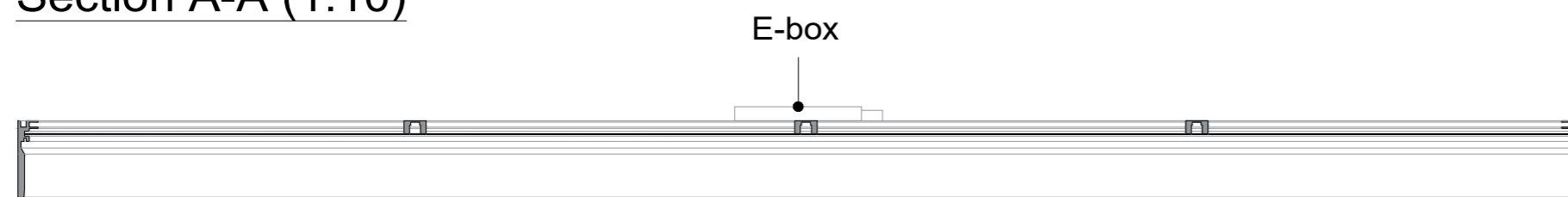

Detail 1 (1:1)

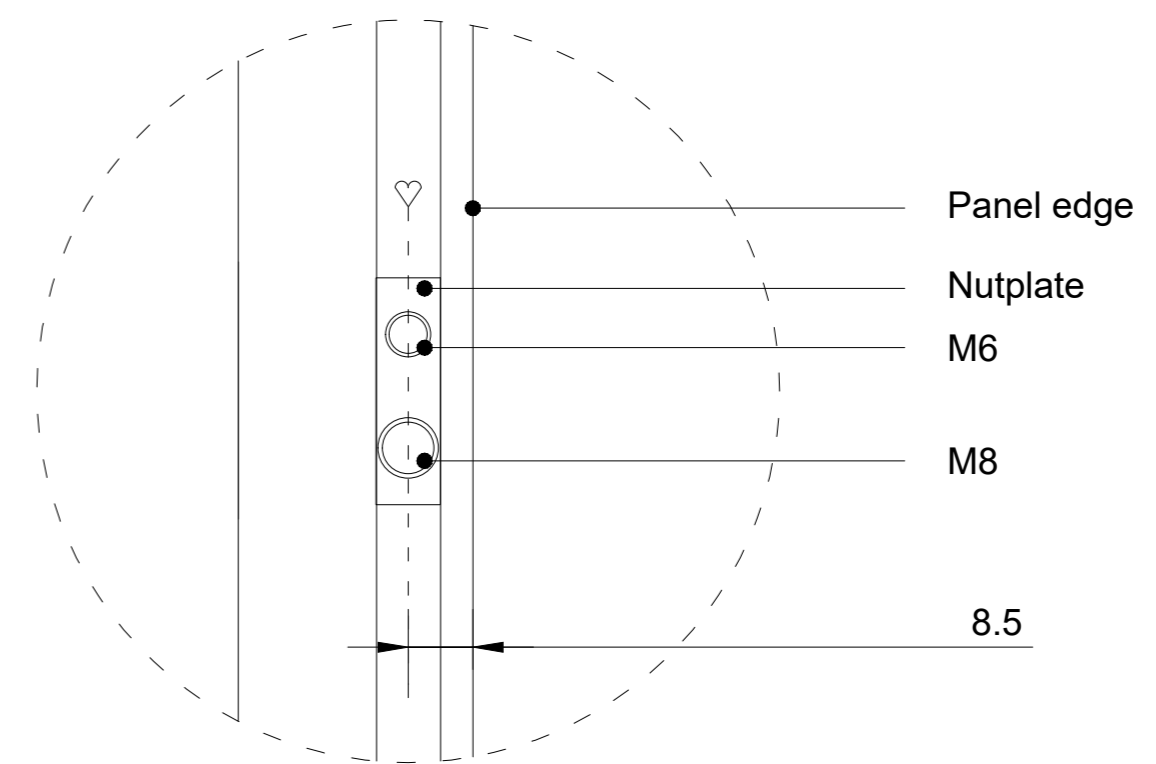

Backview (1:10)

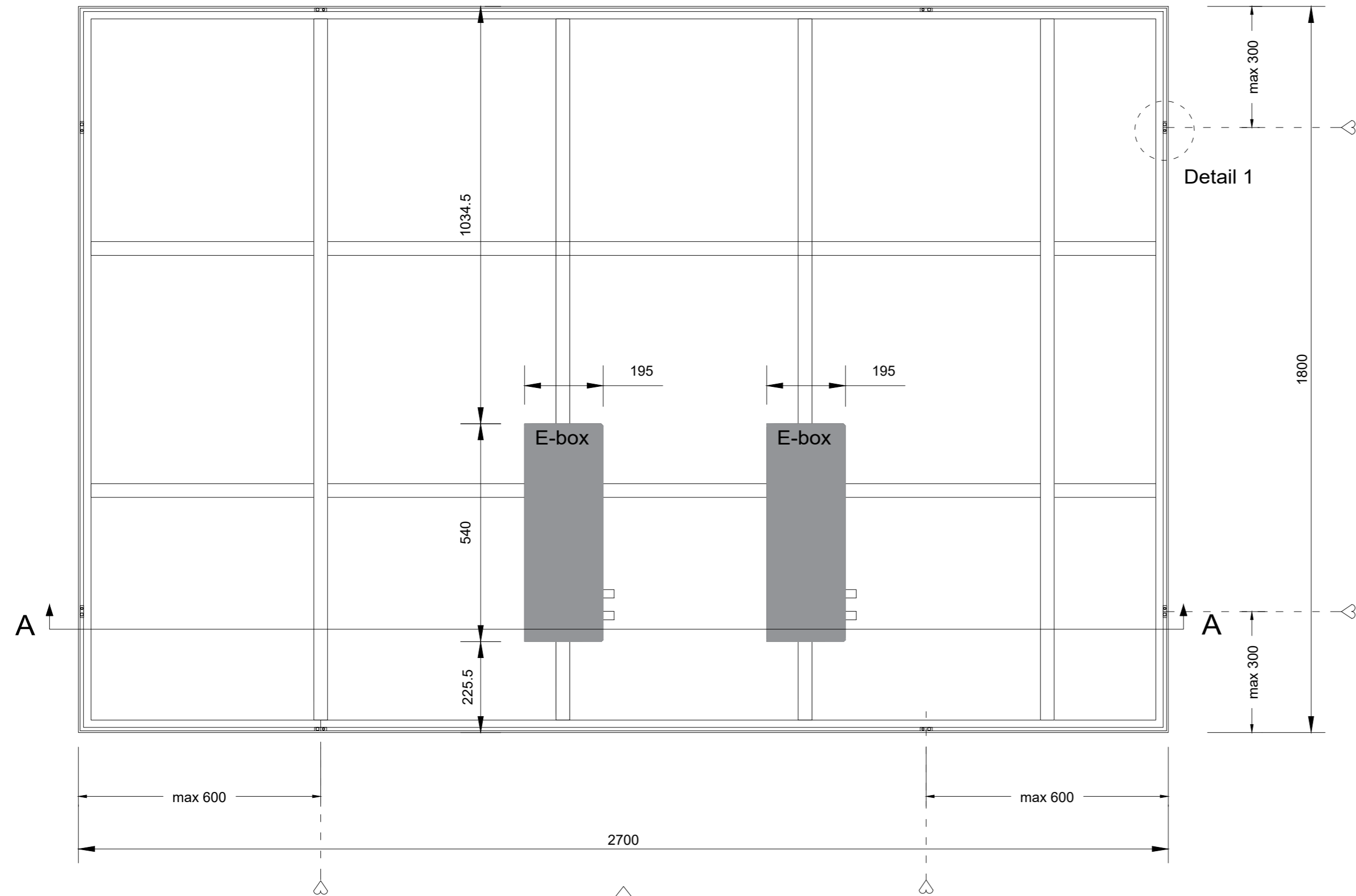

Sideview 1 - mounting position (1:10)

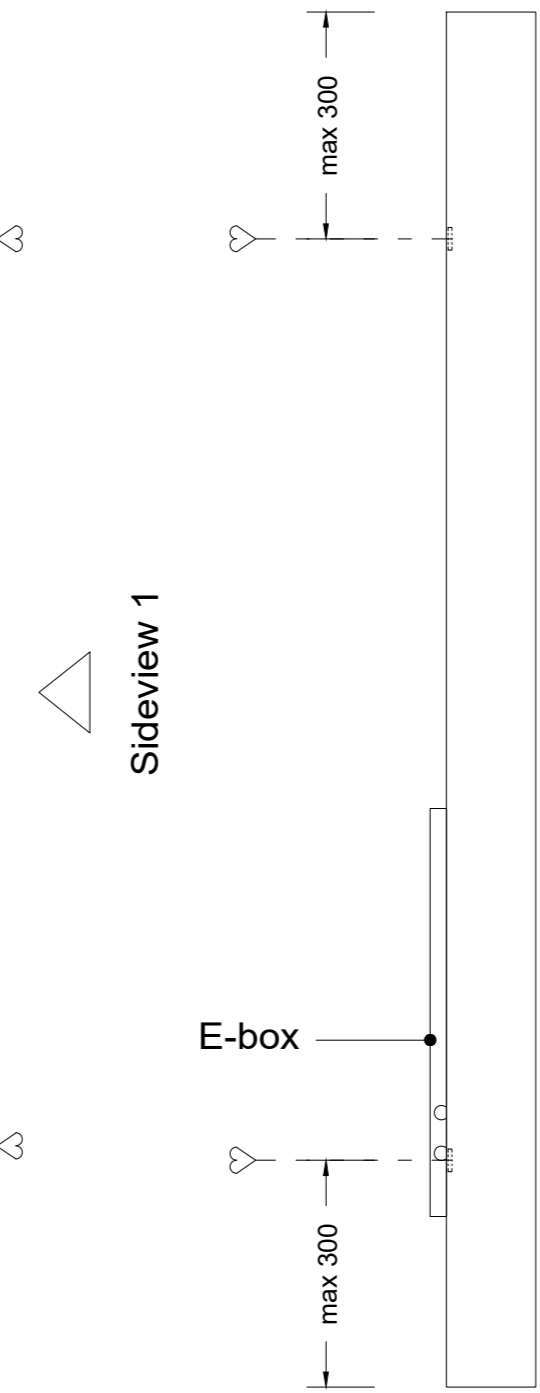

Sideview 2 - mounting position (1:10)

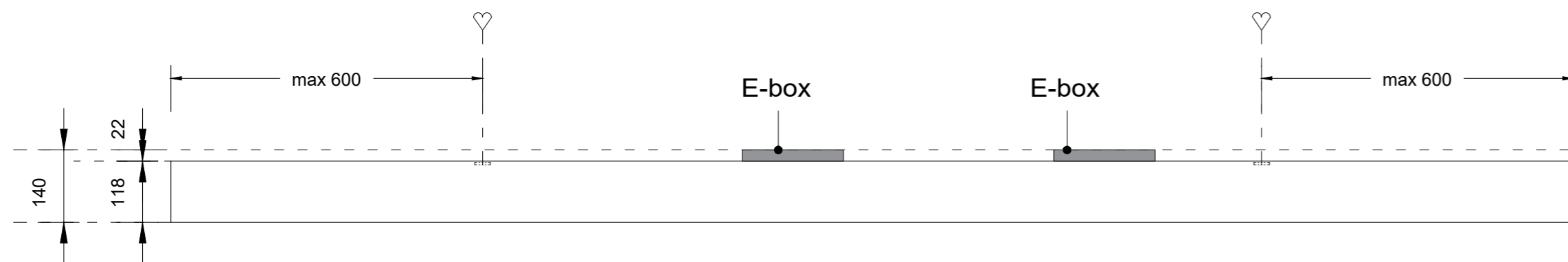

Section A-A (1:10)

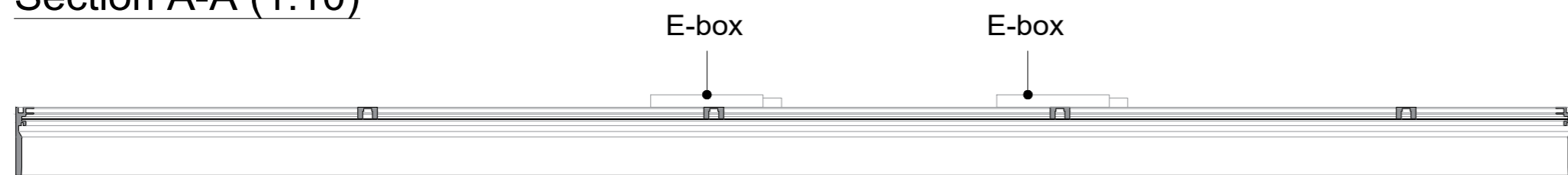

Detail 1 (1:1)

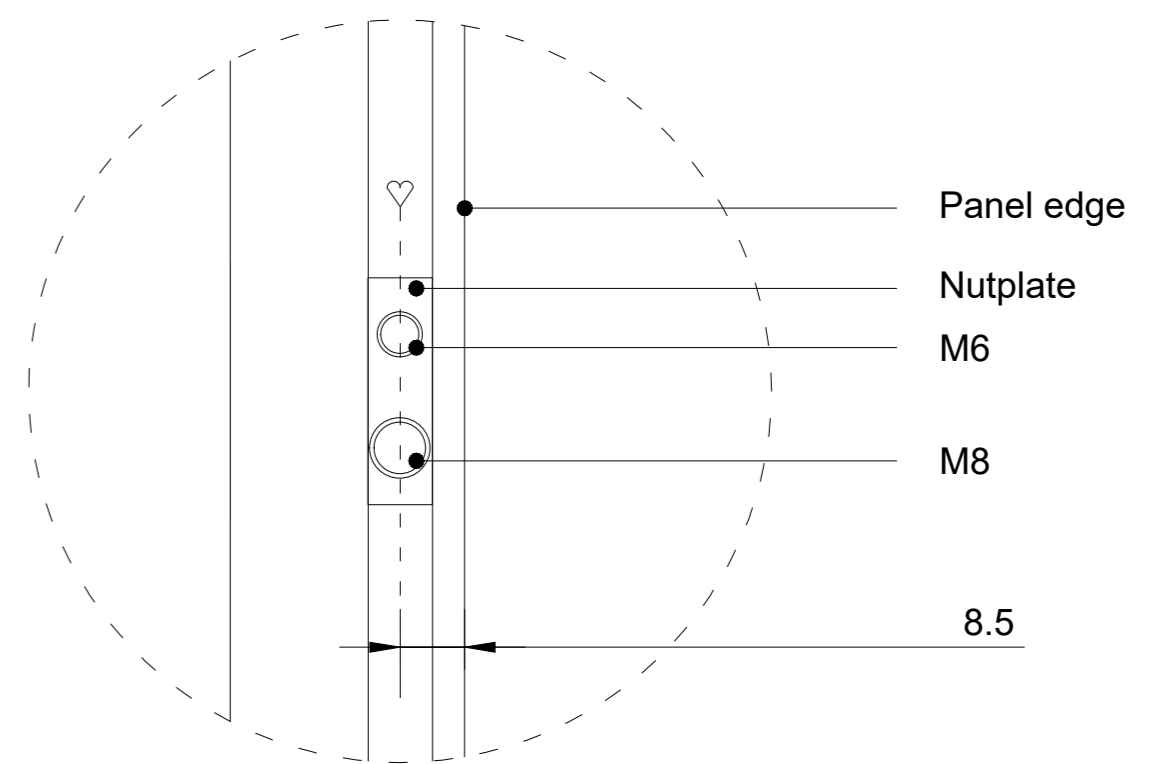

Backview (1:10)

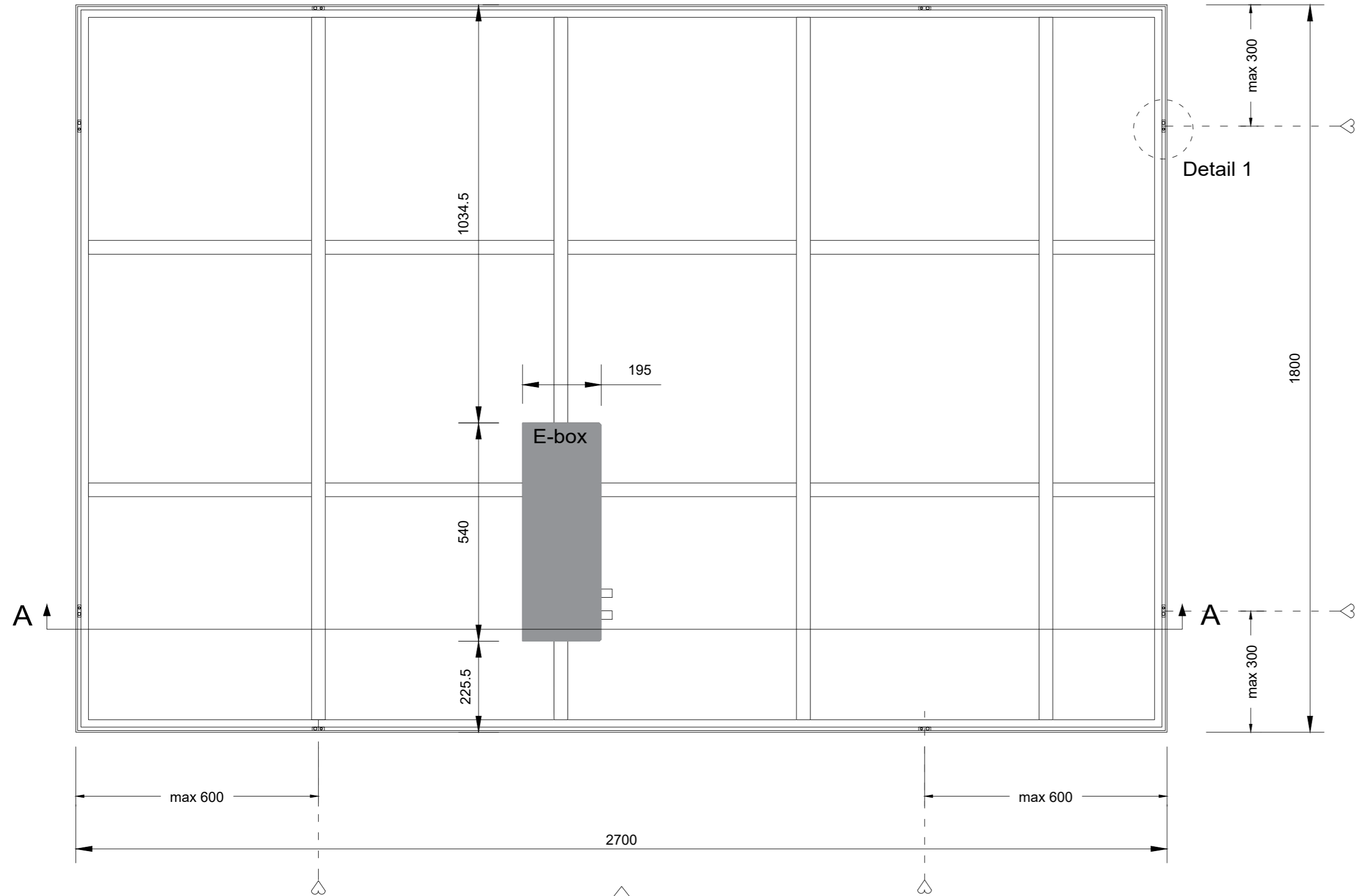

Sideview 1 - mounting position (1:10)

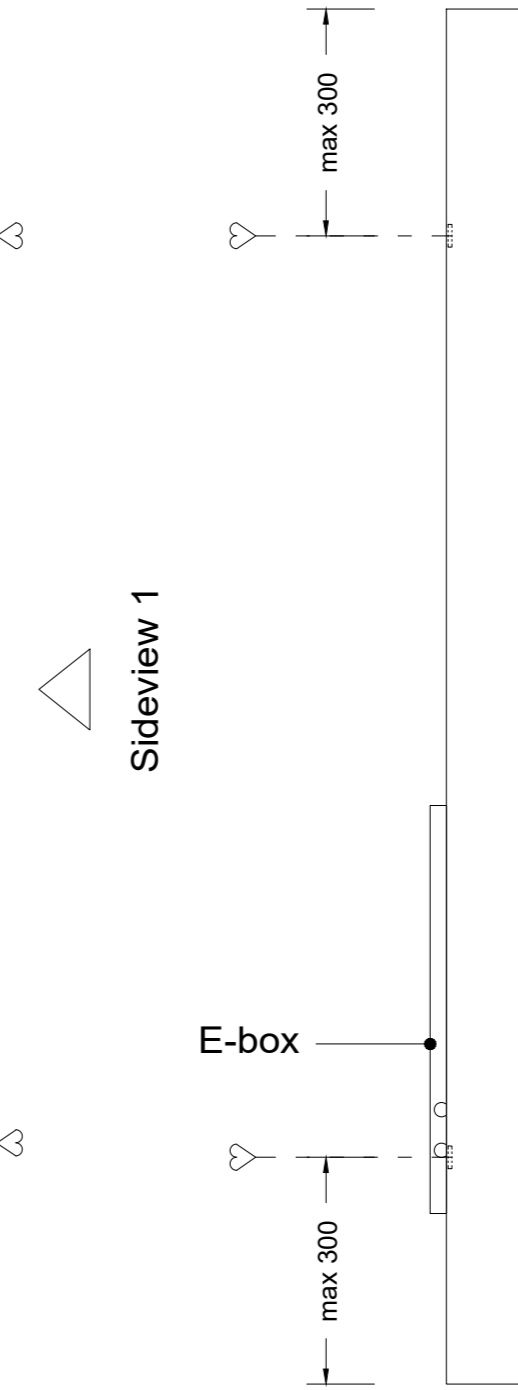

Sideview 2 - mounting position (1:10)

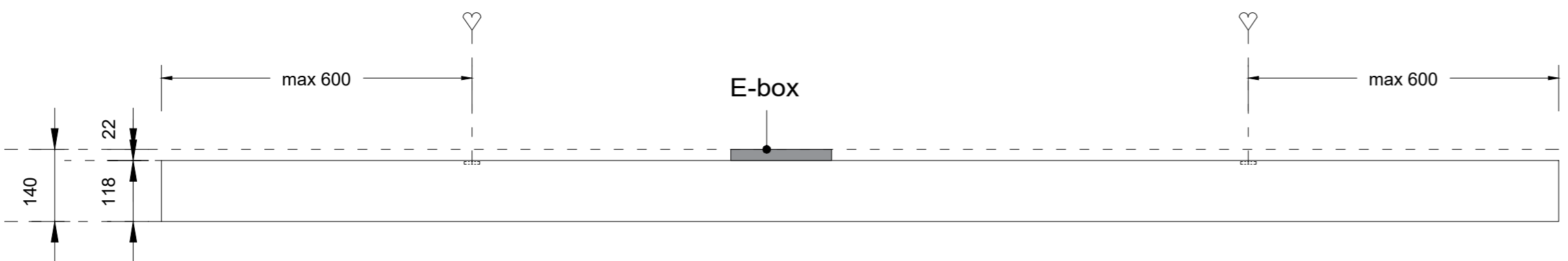

Section A-A (1:10)

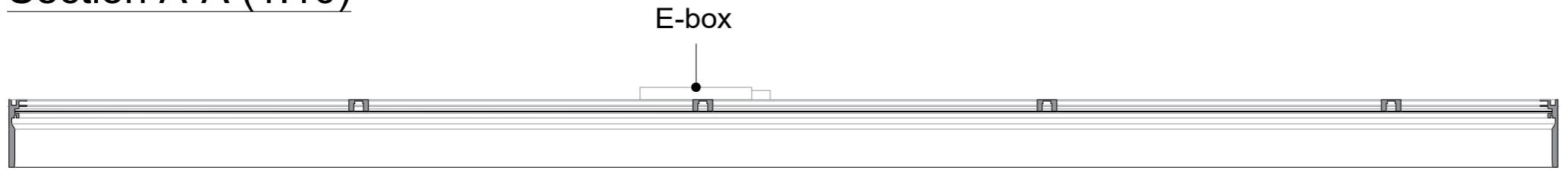

Detail 1 (1:1)

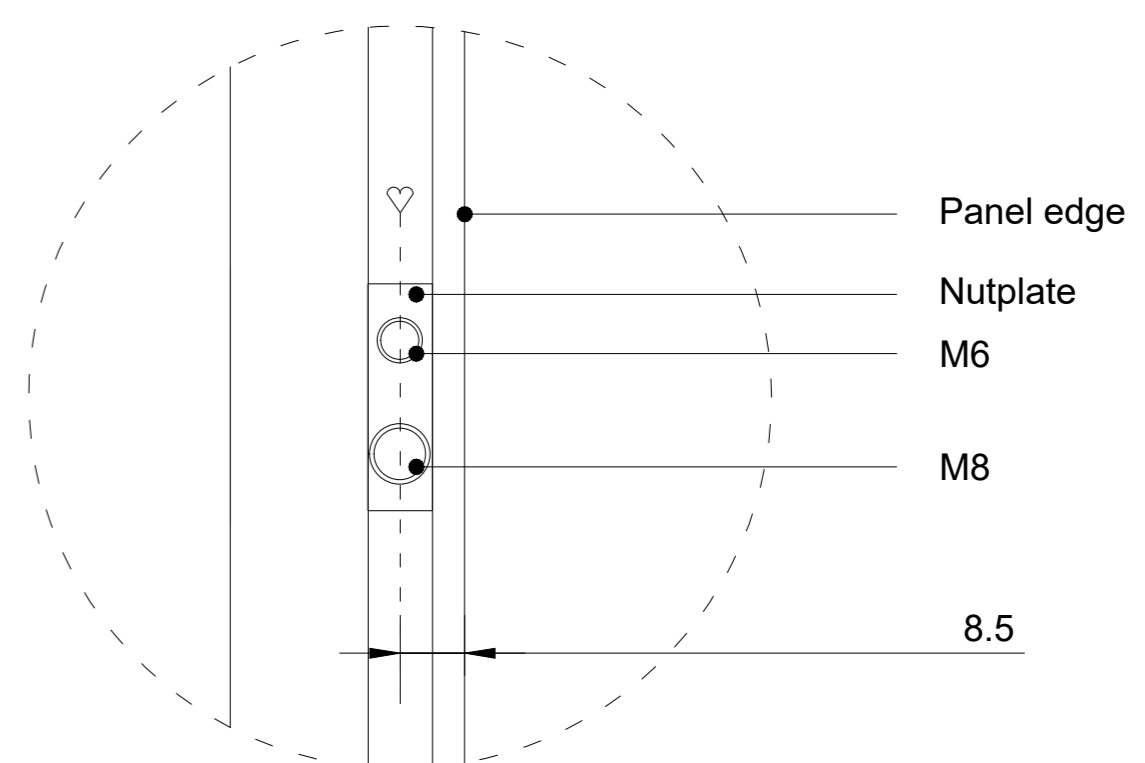

Backview (1:10)

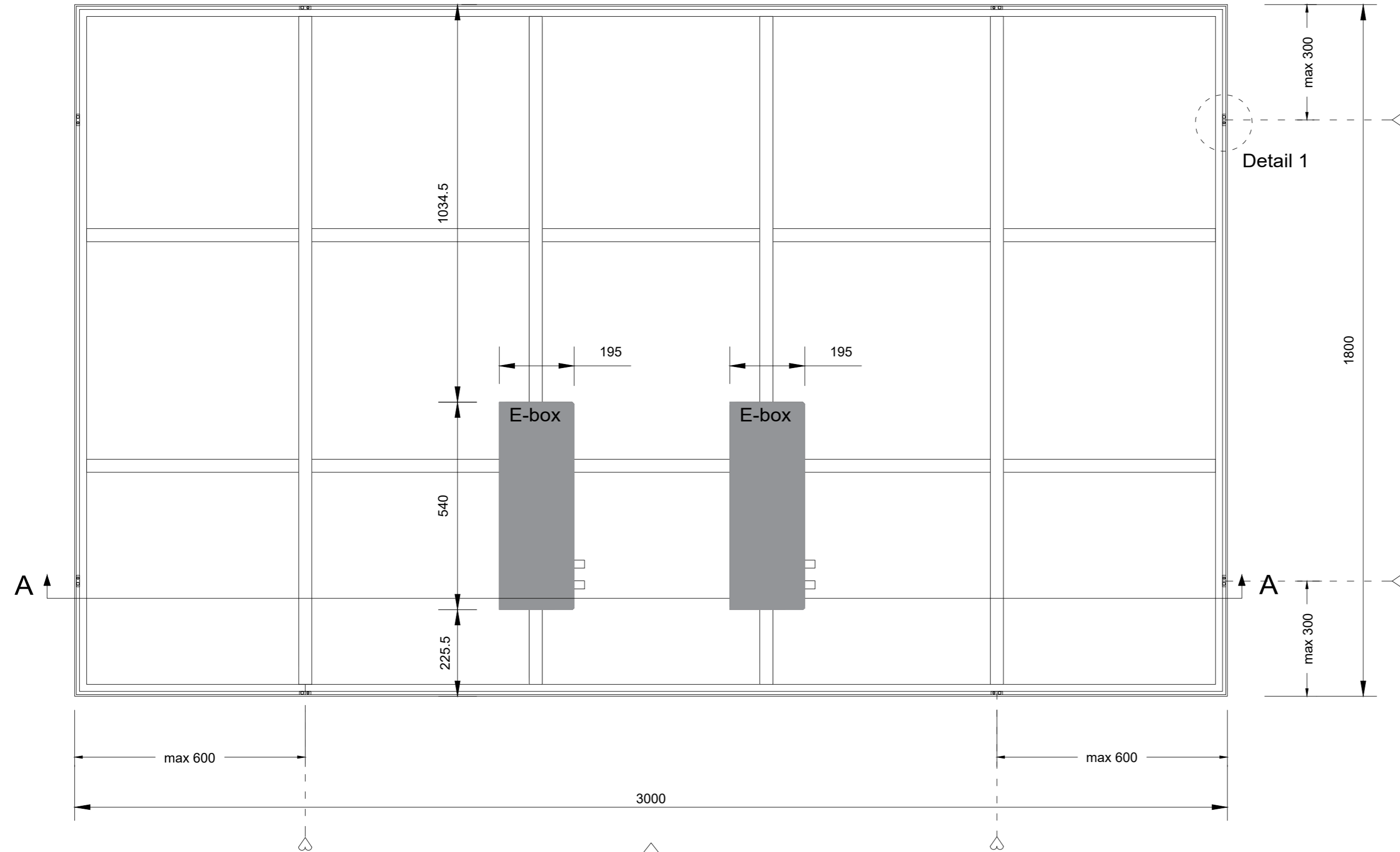

Sideview 1 - mounting position (1:10)

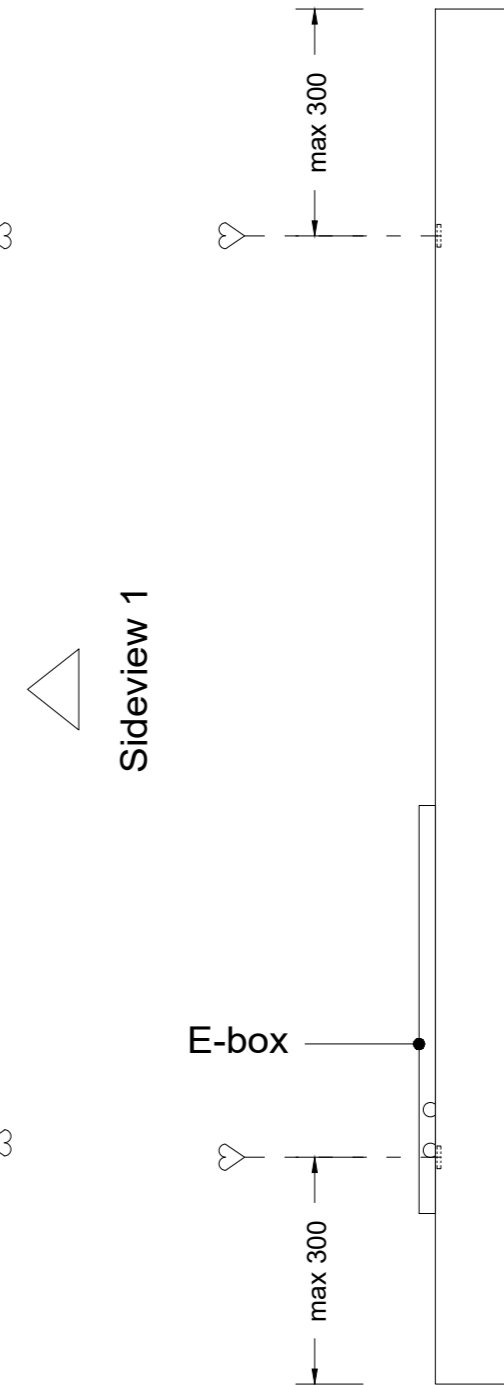

Sideview 2 - mounting position (1:10)

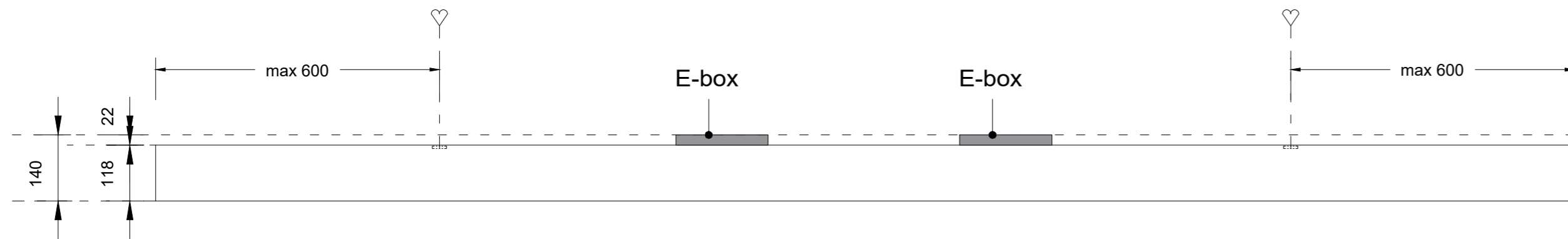

Section A-A (1:10)

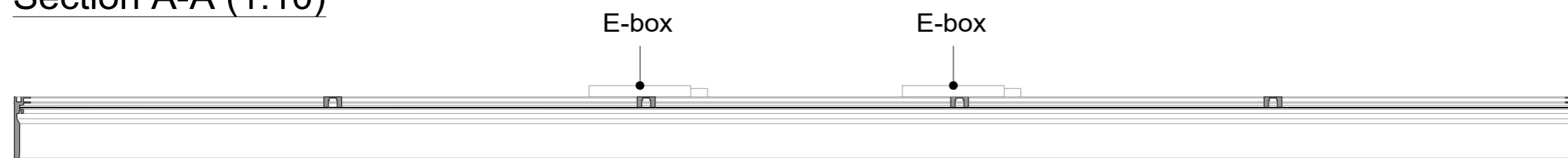

Detail 1 (1:1)

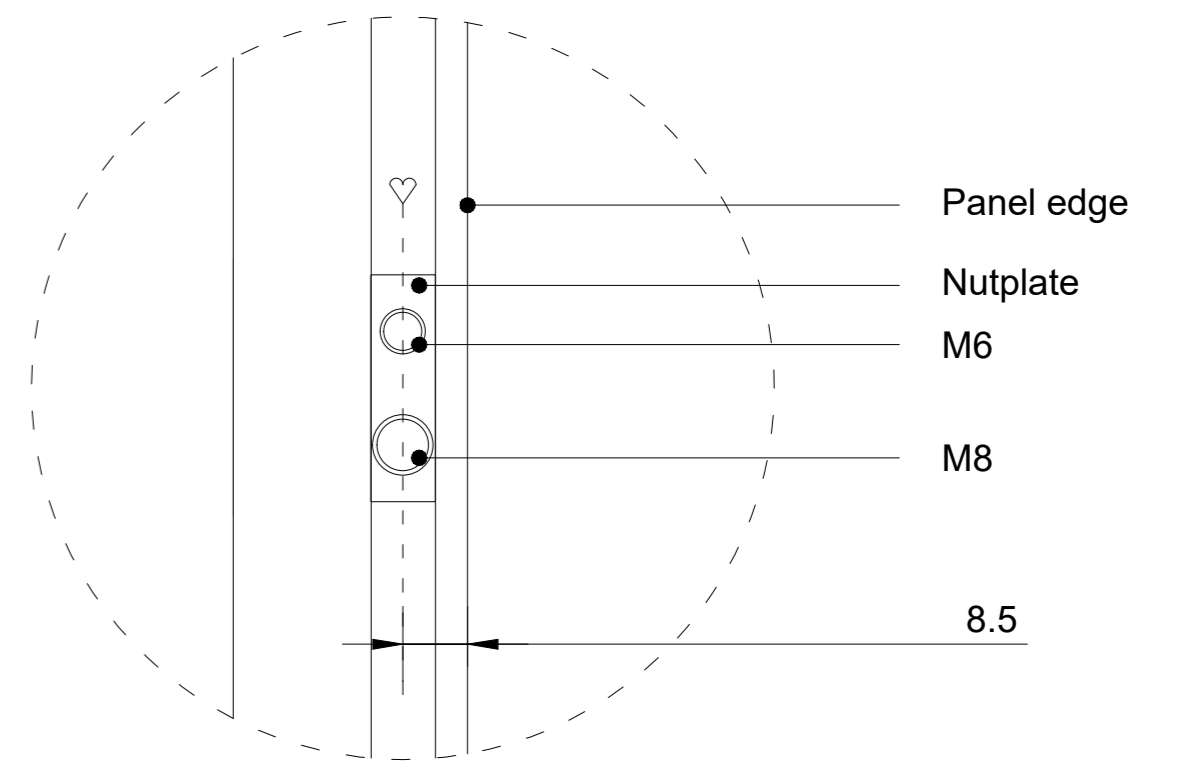

Backview (1:10)

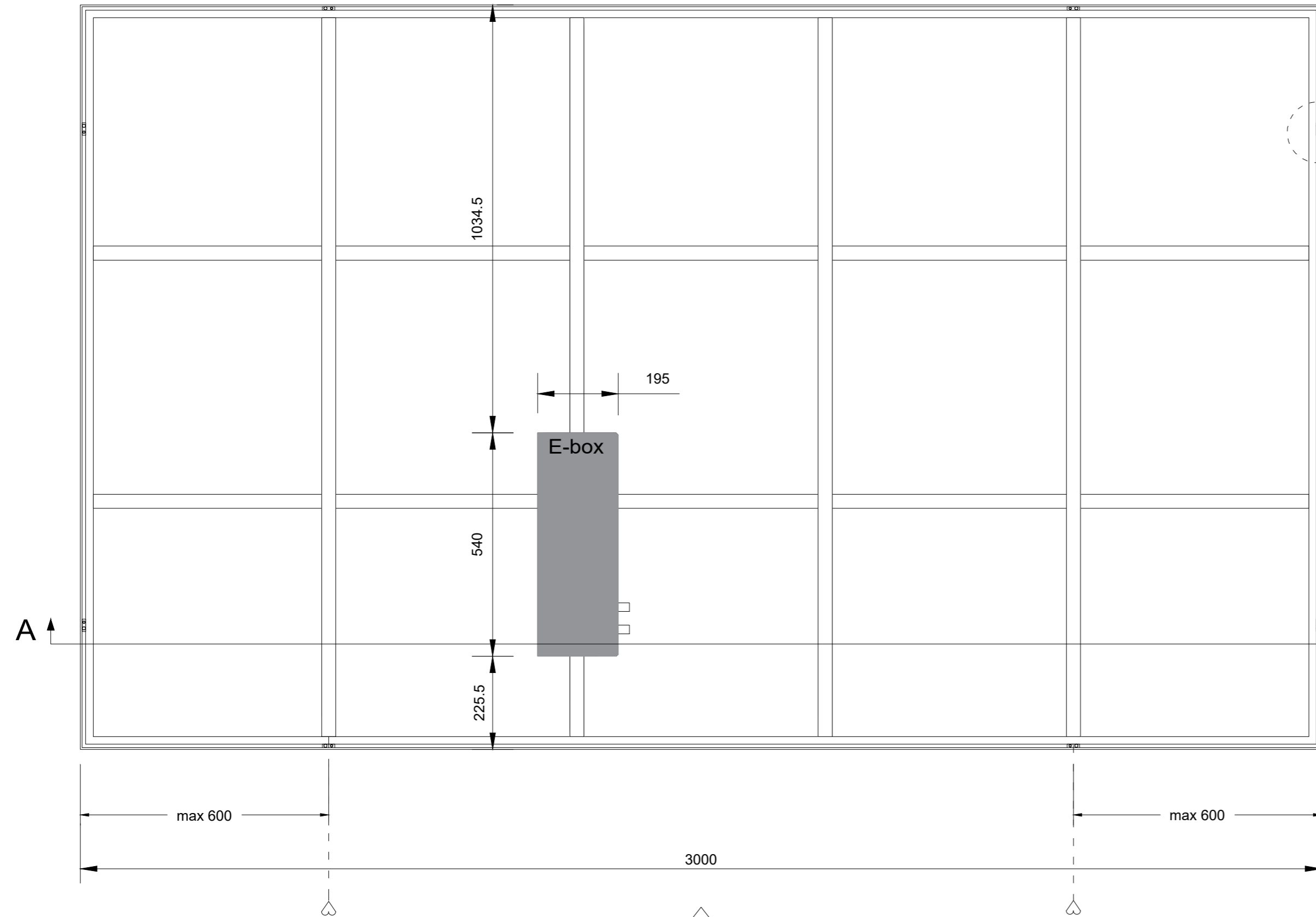

Sideview 1 - mounting position (1:10)

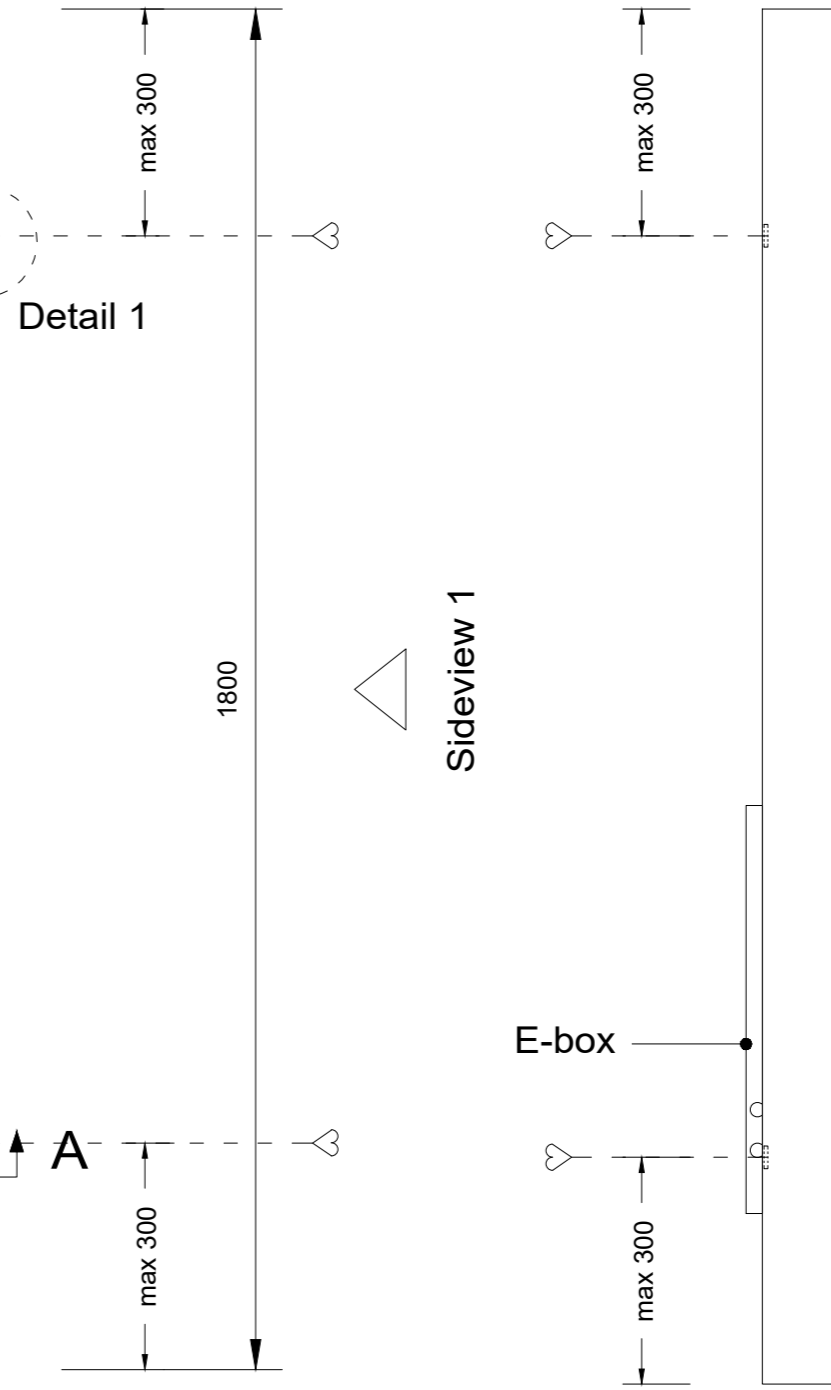

Sideview 1

Sideview 2 - mounting position (1:10)

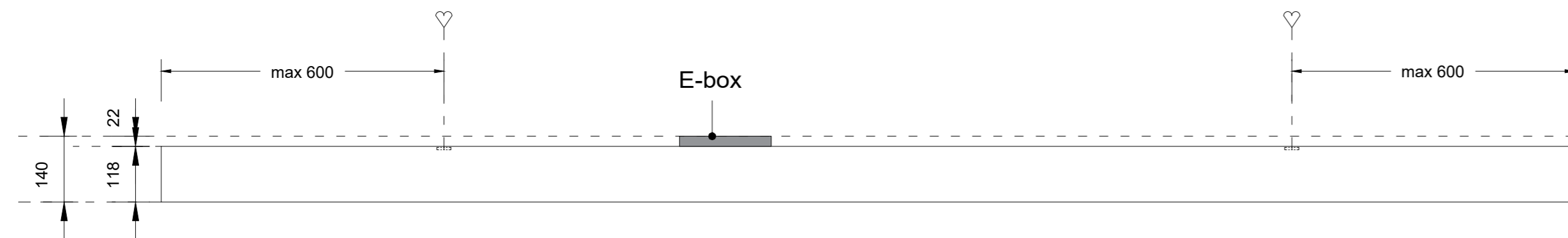

Sideview 2

Section A-A (1:10)

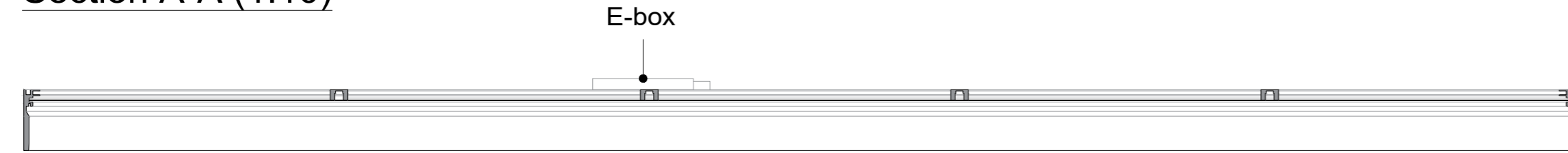

Detail 1 (1:1)

